



799-131

Piggyback EMI Banding Backshell, Dual Port

- Piggyback Dual Round Entry
- Band-Master® Shield Termination
- Top and Side Entry



799-131

This accessory fits Series 790 and 791 connectors:  
790-024, 790-025, 791-001, 791-003

EMI, lightweight, split. 799-131 piggyback backshell fits Series 790 and 791 connectors with rear groove on shell. Dual port banding. Terminate cable shield to backshell with BandMaster ATS band strap. Aluminum with stainless steel screws. Non-environmental.

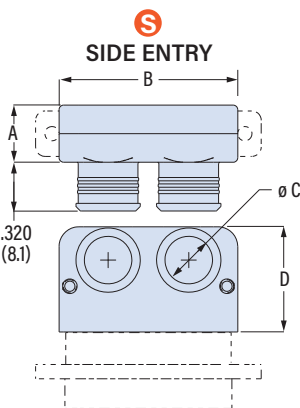
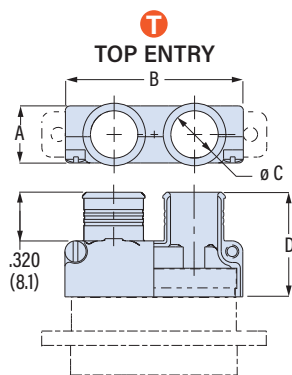

PART NUMBER

Sample PN → 799-131T M H 09 N -01

Base P/N 799-131T T Top Entry  
799-131S S Side Entry

Material / Finish TZ Alum / Tin-Zinc  
M Alum / Electroless Nickel  
MT Alum / Nickel-PTFE  
ZR Alum / Black Zinc-Nickel  
ZI SST / Passivated

Shell Size C D E F G H J K L M

Entry Size	C	Shell Size
03	.109 (2.8)	C thru M
04	.125 (3.2)	D thru M
05	.156 (4.0)	D thru M
06	.188 (4.8)	E thru M
07	.219 (5.6)	E thru M
08	.250 (6.4)	F thru M
09	.281 (7.1)	F thru M
10	.312 (7.9)	F, H thru M
11	.344 (8.7)	H, L, M
12	.375 (9.5)	H, L, M
13	.406 (10.3)	H, L, M
14	.438 (11.1)	M
15	.469 (11.9)	M

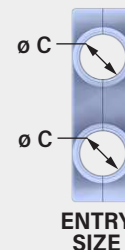

Band N No Band  
M Micro Band Included  
J Micro Slim Band Included  
L Micro-Max Band Included

Height Code	Code	D
-01	.810	(20.6)
-02	.940	(23.9)
-04	1.190	(30.2)
-06	1.440	(36.6)
-08	1.690	(42.9)

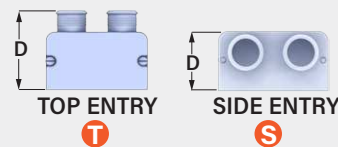

Shell Size	A Max in	A Max mm	B Max in	B Max mm	Available Entries
C	.385	9.8	.785	19.9	35
D	.385	9.8	.885	22.5	35, 04, 05
E	.385	9.8	1.035	26.3	35, 04 thru 07
F	.385	9.8	1.185	30.1	35, 04 thru 10
G	.465	11.8	1.145	29.1	35, 04 thru 09
H	.495	12.6	1.525	38.7	35, 04 thru 10
J	.385	9.8	1.545	39.2	35, 04 thru 10
K	.385	9.8	1.945	49.4	35, 04 thru 10
L	.495	12.6	1.765	44.8	35, 04 thru 13
M	.555	14.1	1.830	46.5	35, 04 thru 15

BAND OPTIONS

Terminate cable braid to backshell with optional band strap and banding tool. Pre-coiled bands are passivated stainless steel. Micro Slim bands have reduced thickness for weight reduction. Micro-Max bands are high-tension for lower-resistivity termination.

Band Type and Width	Hand Tool	Pneumatic Tool
Micro: .12 (3.0)	601-101	601-107
Micro Slim: .12 (3.0)	601-122	601-123
Micro-Max: .12 (3.0)	601-129	601-118