

QwikConnect

GLENAIR ■ APRIL 2014 ■ VOLUME 18 ■ NUMBER 2

SPECIAL REPORT:

Why Quality Matters



Why Quality Matters

Glenair has a simple and straightforward approach to quality. It is based on following established industry models and practices—particularly those defined in the AS9100 SAE International Standard for Aerospace and the ISO 9001 International Standard—combined with an undying commitment to customer satisfaction. The commitment to customer satisfaction ensures we don't lose sight of overall customer and market requirements even as we focus our attention on the systems and processes we employ to make the products we sell.

This special report asks, somewhat rhetorically, Why Quality Matters? The answer (spoiler alert) is right on the cover of this issue of *QwikConnect*. While Glenair is not a systems manufacturer or OEM, our component part technology gets used every day in critical circumstances by folks whose lives are on the line. From astronauts to pilots, soldiers to miners, Glenair is right there where the action is. So we get

why quality matters. But if you are an existing Glenair customer—



or in the process of considering Glenair technology for your next interconnect application—you may have some more specific questions on your mind. You may be asking:

How can I be sure Glenair products are in fact high-quality? How can I be sure the solutions I'm buying from Glenair will deliver reliable, long-term performance? How can I be sure we will get our products on time and in the correct quantity ordered?

A Comprehensive Response:

We believe our history and our company culture are key elements in our quality story. So we'd like to provide a little background on what makes us tick before we tackle the meat of the questions above—and hopefully address any other quality assurance issues or concerns you may have.

Location Glenair is headquartered at our original factory site in Glendale, California; with two additional factories in Bologna, Italy and Mansfield, England. Glenair has resisted chasing low-cost manufacturing opportunities off-shore, believing we will always be better positioned to meet the requirements of our market with high-quality materials, labor, and factory infrastructure we can control in Southern California or in our modern facilities in England and Italy. We like to think of ourselves as a uniquely responsive interconnect company of scale. No other company combines the responsiveness of our technical support team, the productive capacity of our first-world based factories, the speed and availability of our massive same-day inventory, and, above all, our willingness to tackle even the most challenging interconnect problems—from small quantity specials to high-volume assemblies and integrated interconnect systems. But we can only do that with the caliber of people and infrastructure available in the U.S. and E.U.

Glenair is laser-focused on performance. While performance in our industry is sometimes measured in terms of lean efficiency, we measure it more in terms of velocity; i.e.

Glenair corporate headquarters,
Glendale, California: At home in SoCal
since 1956

GLENAIR:
Design Partner to the
Interconnect Professional

fast turnaround on quotes, reduced lead-times on orders, accurate and reliable delivery of orders (including required quantities), and in-stock availability of high-demand part numbers. Velocity and performance for us also means extremely high levels of customer service, technical support and on-demand engineering. It should come as no surprise that in order to operate this unique model successfully, Glenair operational processes often fall outside conventional norms found elsewhere in our industry. For this unconventional approach, we make no apology. We have prospered in a very competitive industry and as a result have been able to service our customers year-after-year with consistently high levels of product quality and delivery.



Capacity We supply our customers with interconnect hardware based on mature designs and mature manufacturing processes that meet all industry specifications and requirements. We offer short and ever-shrinking cycle and lead times (2 weeks typical)—made possible by production and process models that emphasize ample human resource and factory capacity—especially for those instances when forecasts or emergency requirements do not conform to planned production schedules. For example, we maintain a three months minimum on site inventory of raw materials, components and finished items to eliminate risk that we might get caught short on materials due to an unforeseen supply-chain interruption.

Our factories feature complete vertical integration—with only a few exceptions—with capacity utilization (facilities, machines, people, etc) always less than 80%

Our southern California factory is positioned for growth. Our factory buildings are purpose-built, modular cells focused either on general manufacturing functions (such as our milling and machining centers) or the specific processes required to produce each of our 20 plus product lines. At all

times we operate our physical plant with an eye towards future capacity and growth. We follow an “extra table in the restaurant” model which demands we always maintain additional capacity for new work—even at the cost of operating manufacturing units below what some measures might define as “optimal operational efficiency”. By the way, we are the world’s largest manufacturer of high-performance backshells, micro-d connectors, connector savers, miniaturized mil-caliber circulars, aerospace hermetic connectors, qualified conduit systems and fittings and more—so we’re pretty confident this business model not only works, but works well over time.



Glenair composite injection molding cell, with plenty of room for ongoing growth



Every factory operation is controlled by Glenair—from machining to molding, plating, testing and assembly

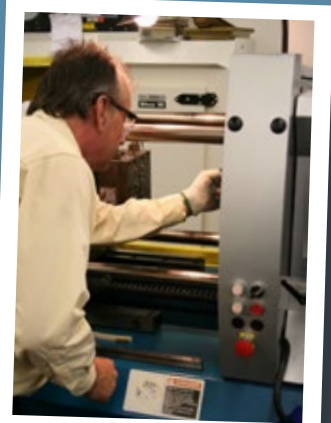

High-Production Injection Molding



One of North America's Largest CNC Milling and Machining Installations



Cable Assembly Overmolding



Clean Rooms for Filter Array and Printed Circuit Board Assembly



NASA-STD-8739.3/ENG-5213 Certified Soldering



The Industry's Most Advanced EMI/RFI Braided Shielding Operation

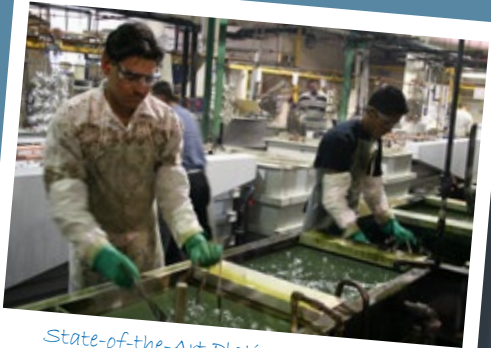

State-of-the-Art Plating Capabilities



In-House Connector and Cable Harness Assembly



Test and Burn-In Labs for Both Electrical and Optical Systems

Worldwide Support We serve a worldwide market. 50% of the products we sell worldwide are “standard” catalog solutions and 50% meet individual customer requirements. We offer worldwide application engineering and technical support at levels higher than any competitor in our industry. We have over 100 dedicated interconnect application specialists in the field every day. Our US factory (and UK and Italy satellites) house the most experienced engineering and technical support team in the interconnect industry. By our estimates, Glenair fields more front-line application sales and technical support professionals than the rest of the high-performance (Mil-Aero) interconnect industry combined—All factory trained and positioned to meet both standard product sourcing as well as made-to-order application development. Our technical support team—and all the other folks in the Glenair family—are the principle reason behind our consistent growth and performance in a tough market. And it’s no surprise the industry’s best are attracted to our company and tend to stick around once they have come on board.

Certified and Registered Quality System The Glenair Quality Management System, or QMS is a certified and audited system that ensures every process affecting quality is properly formulated and performed. Our certifications communicate that we’re serious about quality and consistency. Many customers, especially in our

military/aerospace markets, require QMS certification to do business with us. Glenair’s QMS is certified to multiple industry and international standards depending on factory location. Independent audits are conducted every 6 months on segments of our QMS processes to ensure we meet requirements on an ongoing basis. A complete re-certification audit of the entire Glenair QMS system is conducted every 3 years. In addition, many large OEM’s conduct their own annual audits of Glenair process and product quality.



Glenair is ISO 9001:2008 and AS9100:2009 Rev. C certified and registered in North America; IRIS (International Railway Industry Standard), AS9100 SAE Aerospace and ISO 9001 certified and registered in Italy, and AS9100 certified and registered in the U.K.



Qualified Products: Glenair is a Mil-Aero connector supplier. Our product quality begins in engineering and is realized in manufacturing. One of the key ways we ensure both of these realms are functioning smoothly is to submit both designs and physical specimens into the military QPL process administered by the Defense Logistic Agency of the US government. These certification exercises are multi-year activities that test every aspect of a connector's performance in such areas as mechanical durability, corrosion resistance, temperature tolerance, and most importantly, electrical circuit performance under various forms of stress such as vibration and shock.

Military Standard Part Numbers Available From Glenair

D38999/21	M81511/18	MS27469	M28840/13
D38999/22	M81511/19	MS27470	M28840/15
D38999/23	M83513/01 thru /33	MS27471	M28840/23
D38999/25	M81914/1 thru /11	MS27475	M28840/24
D38999/27	M83723/15	MS27476	MS3057
D38999/28	M83723/35	MS27477	MS3105
D38999/32	M83723/50	MS27478	MS3115
D38999/33	M83723/59	MS27501	MS3152
D38999/41	M83723/60	MS27502	MS3153
D38999/43	M83723/61	MS27506	MS3154
D38999/45	M83723/70	MS27507	MS3158
D38999/48	M83733/15	MS27510	MS3180
D38999/50	M85049/1 thru /31, /33 thru /47, /49, /51 thru /63, /69, /75 thru /96, /103 thru /130, /134 & /139 thru /142	MS27511	MS3181
M81824/1-1,-2,-3	M8528/1 thru /3	MS27512	MS3184
M38999/9, /10	M32139/01, /02, /03, /04	MS27557	MS3186
M24308/9	MS17349	MS27558	MS3188
M24758/1 thru /9, /11 thru /19	MS17350	MS27559	MS3189
M29504/4 & /5	MS25042	MS27741	MS3410
M39029/56, /57, /58, /83, /84, /106, /107	MS25043	M28840/1	MS3416
M81511/13	MS25043	M28840/2	MS3417
M81511/14	MS27291	M28840/3	MS3418
M81511/16	MS27296	M28840/6	MS3419
M81511/17	MS27297	M28840/7	MS3420
		M28840/8	MS3437
		M28840/9	

Customers: This is perhaps the most important measure of quality and reliability of all: the many world-class OEMs and system manufacturers who have tested and qualified our products for use in their equipment. And Glenair is not a casual or one-time supplier to these companies. We are a top tier supplier to EVERY aerospace company in the world. We have ongoing successful relationships with the companies listed here and hundreds more. For many of these OEM, system and sub-system manufacturers, Glenair has become their principal interconnect design partner and supplier—especially for the most challenging and difficult components they buy—such as EMI filters, hermetics, and composites.





Grand Central Terminal, Glendale, Ca

Glenair has a track record of innovation and excellence in the design and manufacture of high-performance interconnect solutions

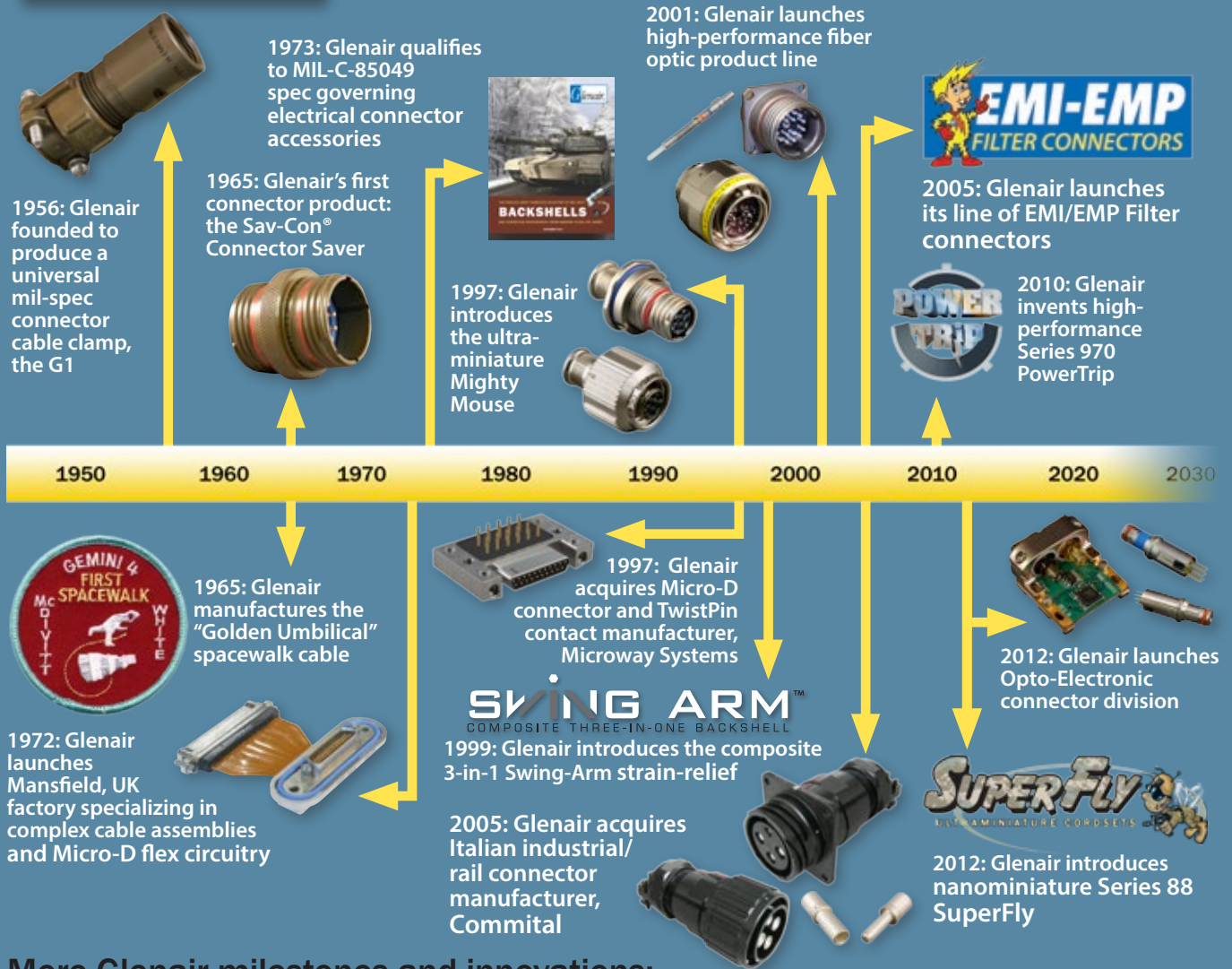

More Glenair milestones and innovations:





Glenair design expertise extends from innovative composite backshells to complex optoelectronic assemblies

The industry's most experienced engineering and design team—in every discipline—from backshells to flex-circuit boards



Let us be your design partner: Glenair has the most liberal NRE policy in the industry



Glenair's engineering team in Glendale is augmented by regional teams worldwide, and we love to travel. Our place or yours? We work at our customers' convenience.



Glenair excels in the design of miniaturized components such as this full Gigabit Ethernet contact

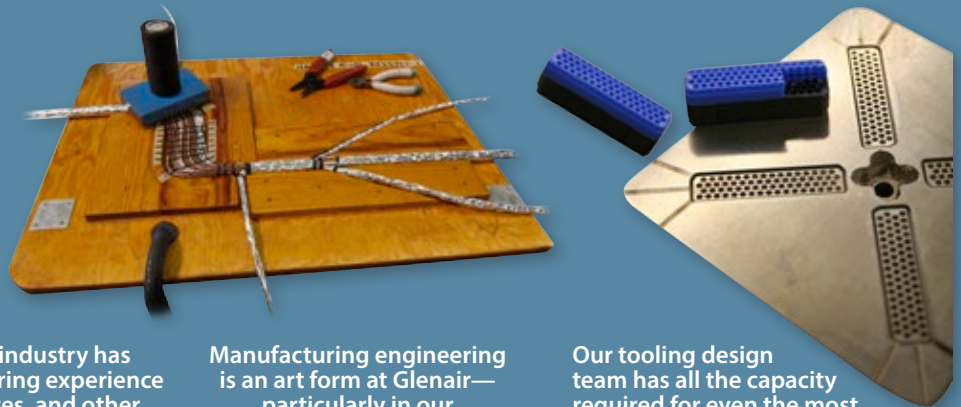

No one in our industry has more engineering experience with composites, and other innovative materials, than Glenair

Manufacturing engineering is an art form at Glenair—particularly in our complex cable group

Our tooling design team has all the capacity required for even the most aggressive production schedules



Four of the many reasons our engineering team takes their work so seriously:

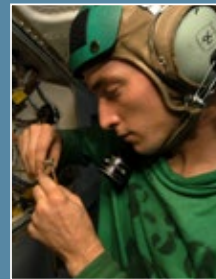

Applications: Let's discuss a few signature Glenair applications, starting with the golden umbilical life support cable used by Commander Ed White in the first space walk in 1965.

This was a complex cable assembly with an exacting set of performance requirements. Although dated, it reflects Glenair's design and fabrication expertise and that we have been a trusted supplier to the interconnect industry since 1956.

Today we continue to fabricate high-performance cables for space, from rugged Viton overmolded designs to ultra-lightweight SpaceWire jumpers for the high-speed space data transmission protocol.

Glenair Micro-D and Mighty Mouse connectors—including standard environmental products, hermetics, filters, and flex assemblies—were used in the hundreds on the successful Mars Curiosity Explorer built by JPL and launched by NASA. Glenair was invited to be on hand at JPL for the landing on Mars and we were as proud of the role our products played in the successful mission as the many other top-flite suppliers that contributed to the endeavor. Imagine the care and attention JPL gave to selecting technology for this project when the failure of any single element could lead to the failure of the entire mission. It is humorous to observe, but nevertheless true, that when you count up the number of Series 80 Mighty Mouse, Micro-D's and other connectors supplied by Glenair on the Mars Explorer, Glenair is by far the most popular make of connectors used on Mars.

One of the most important measures of interconnect product quality is its ability to withstand the constant, relentless abuse of harsh application environments—and nothing gets more punishment and abuse than a military carbine. Designed for use by armored troops and marines, every component on the M4 carbine must be able to withstand severe vibration and shock, the daily wear and tear of cleaning and re-assembly, exposure to sand, dust,

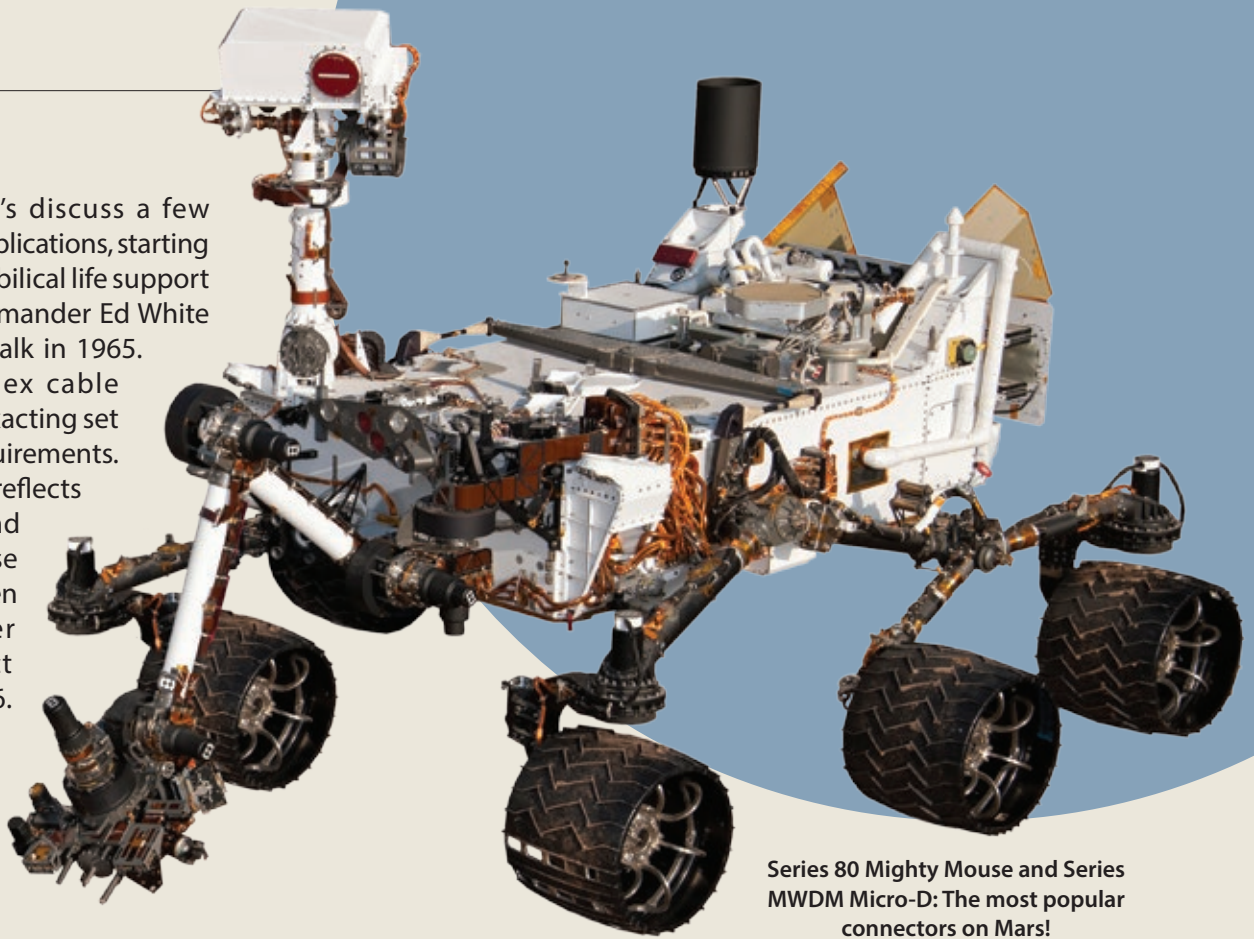

Series 80 Mighty Mouse and Series MWDM Micro-D: The most popular connectors on Mars!

water and mud, and the extremes of cold and heat. And only one got chosen, the Series 804 Mighty Mouse made by Glenair.

The M4 carbine weapon sight with its push-pull Mighty Mouse connectors isn't the only place Glenair excels in soldier system applications. In fact, Mighty Mouse won out against all other competing solutions to be named the standard connector for the US Land Warrior and next-generation NETT Warrior systems and components—meaning thousands of Mighty Mouse connectors now receive the ultimate quality test on a daily basis: performing per design and requirement on the world's most widely used future-soldier platform, as well as a dozen other military and civilian platforms worldwide.

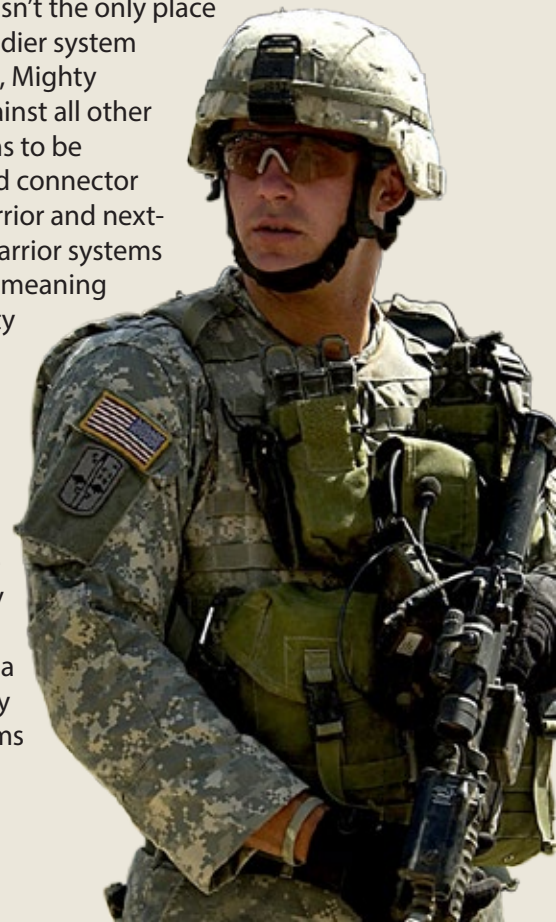

Helicopters are another tough environment due to vibration and shock requirements as well as the general need for robust mechanical performance. But rotary aircraft have other tough requirements as well. For example, the need to reduce size and weight in interconnect systems but still deliver perfect electrical power and signal performance. The FLIR/TADS Application equipment (shown next page) was down-selected for a major military helicopter upgrade program for its ability to accomplish both these goals. And the connector that helped this project win out against competitor solutions? The ruggedized Series 801 Mighty Mouse invented by Glenair.

“Ruggedized” is one of the most common themes in Glenair interconnect specifications. Our products are frequently chosen because they outperform similar solutions, or as is the case in this ruggedized high-speed computer, met environmental, mechanical and electrical standards that the commercial connectors used on the prototype had failed.



Smaller connectors contribute to smaller PC boards, boxes, and cables

Below are a few more applications in which Glenair technology is currently performing every day to exacting customer specifications. And we could present hundreds of case studies and pictures that make the same point: Glenair gets chosen for the tough jobs because our products reliably perform when and where they are needed.

Glenair has all the necessary qualifications and approvals to meet even the most complex and difficult interconnect requirements. Our factories are vertically integrated and all products are manufactured in first-world settings with an appropriate quality management systems in place. We have a solid track-record of serving high-reliability interconnect customers for well over 50 years and are on the print of hundreds of signature, bench-mark programs. Glenair is proud of the quality and reliability we build into every product and we're positioned to serve our customers with world-class technical support and customer service.

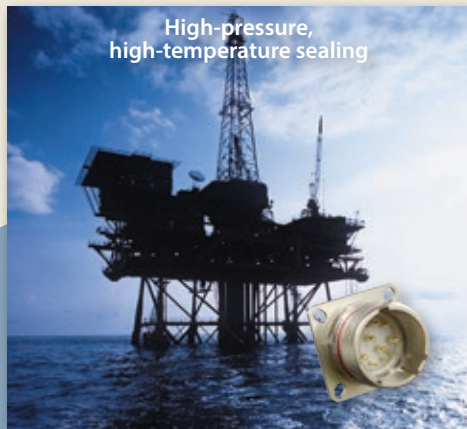

High-pressure, high-temperature sealing



Bandwidth optimization over long distances



High-speed data communications



Interconnect cable weight reduction



System integration and custom packaging



Electromagnetic shielding and pulse hardening



THINK IT · DO IT · BECOME IT

Glenair's commitment to education keeps us—and our customers—at the forefront of interconnect system technology and product quality

Classroom and online certification/training programs



Solder certification training



ESD control training



Fiber optic termination training



Interconnect product training



Multilingual job aids and work instructions provide assembly staff with ongoing education in Glenair and industry best practices



Product briefs for ongoing Glenair and customer product education

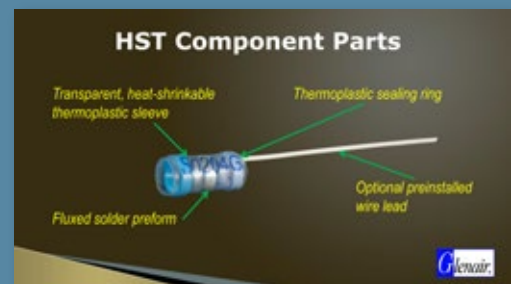

Online and classroom technical training on the complete range of Glenair products



QwikConnect quarterly magazine and technical training posters

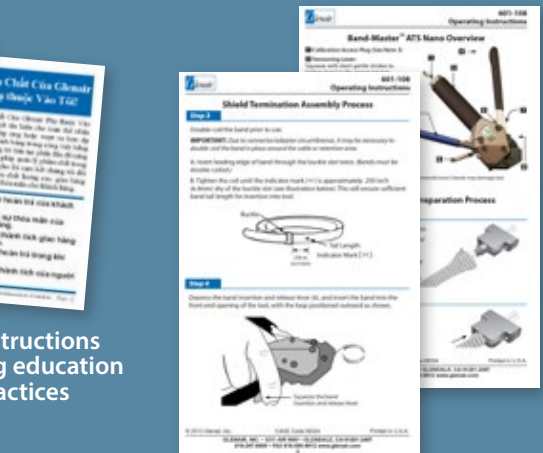

Quality assurance in action

Mighty Mouse technology and Glenair design expertise turns complex interconnect challenges into time and labor-saving solutions for our customers. The quality and timeliness of our deliveries has made Glenair Series 80 Mighty Mouse the industry standard in complex soldier system applications.

Glenair invented the ultra-small form factor Mighty Mouse used in hundreds of the most advanced land, sea, air and space interconnect applications. Today, our factory is positioned to meet every requirement for complex integrated systems—from cable and enclosure design to turnkey electronic system packaging. Glenair is your one-stop-shopping solution for integrated interconnect cabling and electronic equipment.

Lightweight soldier system with ruggedized computing, radio communications, power supply and tactical USB/networking patchcords—all integrated with turnkey Glenair connector technology.



Ultra-flexible RF cable assembly, USB hub, and connectorized black box enclosure—tested, terminated, and ready for immediate application



USB tactical patchcord



AN/PRC series radio connector

Audio frequency 55116 type connector and cable



Turnkey integrated cable and EUD assembly featuring Mighty Mouse, 55116 audio and USB interconnects—all fabricated, assembled and tested by Glenair's Mighty Mouse integrated systems group





USB 3.0 Flash Drive Features 804 Series Push/Pull ruggedized interface available with 8GB, 16GB, 32GB or 64GB storage capacities. Designed for ground soldier data upload and download; IP67 sealed for harsh environments.



Overmolded breakout assembly featuring 100% Glenair content; a true turnkey solution



Non-environmental aircraft cable with integrated circuit breakout box and Mighty Mouse 804 push-pull connectors

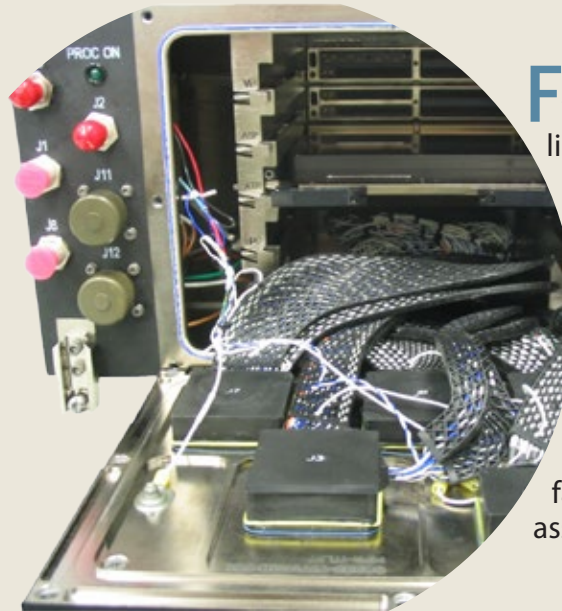

Turnkey overmolded GPS cable assembly with integrated switch

From simple integration projects like the USB 3.0 flash drive shown above, to highly-complex integrated assemblies such as this helicopter package, Glenair has become the industry's design partner and turnkey fabrication and assembly supplier.



AN/PRC-148, AN/PRC-152, 152A, 154 and RF-7800T Radio Connectors with Series 804 Mighty Mouse Push/Pull Interface. Radio connector cables are available as cabled, un-cabled, and pigtail versions. Radio interface features spring-loaded contacts for reliable and mating and are 100% electrically tested for shorts, continuity and insulation resistance at 200 Megohms minimum.



The Series 807 Mousebud™ is a lightweight, low-profile, quick-disconnect connector optimized for rugged applications. Available in plug and receptacle configurations, the spring contact equipped Mousebud™ is a 7-channel, 3 amp per line solution for such applications as heads-up display helmet applications, soldier computers and field communications equipment. The Mousebud™ has a spring-loaded latching mechanism that connects with a simple push, and releases with a low-profile thumb-activated lever on the plug coupling nut. Split-shell plug design provides easy access to wire terminations and an integrated banding porch eliminates the need for additional backshell accessories. Environmentally rated to IP67, the Mousebud™ is ready for application in a wide range of harsh environments.





ISO/IEC 17025

Environmental Test Capabilities

In-house IEC qualified assessment laboratory for electronic components (IECQ)

Environmental testing, consisting of the complete range of mechanical, electrical and environmental stress factors that affect electronic equipment, cabling, and systems is now available from Glenair's IEC/IECQ certified testing laboratories located at our Bologna, Italy facility. Test engineers and technicians follow qualified processes, and report-generation protocols to deliver timely and professional environmental testing services. As an interconnect component manufacturer and wire and cable assembly supplier, Glenair is well-versed in all aspects of qualification testing including corrosion resistance, solvent resistance, electromagnetic compatibility, dielectric withstanding voltage,



current rating and so on. Our test laboratories are equipped with current-generation equipment; maintained in accordance with industry best practices and certification agency requirements. Perhaps most importantly, Glenair environmental test services are offered with accelerated lead times—from initial quoting to final test report delivery.

- Mechanical / dynamic testing for fiber optic systems, electrical components, wiring harnesses
- Broad spectrum of electrical testing (resistance, current rating, EMC shielding and more)
- Heat, cold, and thermal shock testing
- Corrosion and solvent resistance testing
- Fast turnaround on quotes and testing services
- Decades of experience



MECHANICAL / DYNAMIC TESTING

ELECTRICAL AND ELECTRONIC COMPONENTS/DEVICES TESTED
Electrical/Fibre optic connectors
Electro/Mechanical Devices
Wiring Harnesses
Switches
Aerospace Components & Equipment
Automotive Components & Equipment
Railway Components

VIBRATION-SINUSOIDAL (Ambient temperature)	
MECHANICAL/DYNAMIC TESTS	STANDARD
Freq. Range: 5 to 2000 Hz	BS EN/IEC 60068-2-6
Peak thrust: 8,90kN	EIA-364-28
Max pk/pk displacement: 50mm	

VIBRATION/RANDOM (Ambient temperature)	
MECHANICAL/DYNAMIC TESTS	STANDARD
Freq. Range: 5 to 2000 Hz	BS EN / IEC 60068-2-64
Peak thrust: 5,76 kN	EN 61373
Max pk/pk displacement: 50mm	EIA-364-28

SHOCK (Half sine, Sawtooth, and Trapezoidal waveforms)	
MECHANICAL/DYNAMIC TESTS	SPECIFICATION APPLICABLE
Peak thrust : 17,36kN	BS EN / IEC 60068-2-27
	EIA-364-27
	EN 61373

BUMP (Half sine)	
MECHANICAL/DYNAMIC TESTS	STANDARD
Severity: 20/40 gn	BS EN / IEC 60068-2-29:1993

DISCONTINUITY (During vibrations)	
MECHANICAL/DYNAMIC TESTS	STANDARD
1µs Electrical discontinuity	EIA-364-28

Controlled vibration and shock testing ensures electrical and electronic components can withstand specified forms of dynamic stress encountered during operation and shipping.

Available Tests:

- **Vibration sine**
- **Vibration random**
- **Bump**
- **Shock**

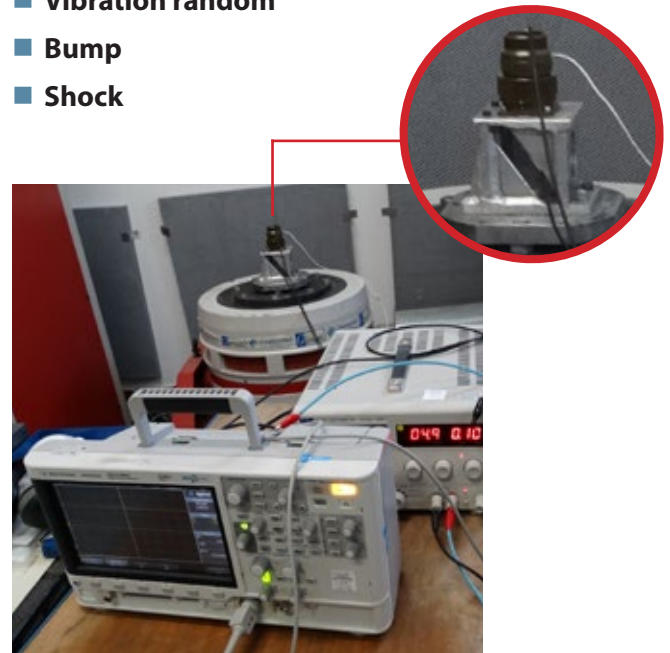

ELECTRICAL / EMC TESTING

ELECTRICAL	
EMC	SPECIFICATION APPLICABLE
Shielding effectiveness	BS EN / IEC 62153-4-7
Tiaxial Method	
9 kHz - 2,6 GHz	
CONTACT RESISTANCE	SPECIFICATION APPLICABLE
DC Voltage	BS EN / IEC 60512-2-1
20 mΩ - 200 kΩ	BS EN / IEC 60512-2-2
1 μΩ	EIA-364-06
INSULATION RESISTANCE	SPECIFICATION APPLICABLE
DC Voltage	BS EN / IEC 60512-3-1
1 - 1500 V	EIA-364-21
100 Ω - 2000 TΩ	
DIELECTRIC WITHSTANDING VOLTAGE	SPECIFICATION APPLICABLE
AC Voltage 50 Hz : 0 - 12 Kv	BS EN / IEC 60512-4-1 EIA-364-20
TEMPERATURE RISE AND CURRENT DE-RATING	SPECIFICATION APPLICABLE
DC Current : 0 - 2000 Ampere	BS EN / IEC 60512-5-1 BS EN / IEC 60512-5-2 EIA-364-70

Electrical / EMC Testing services cover the complete range of performance requirements for interconnect cabling and electronic components. Glenair brings years of EMC design engineering experience into the testing process, ensuring equipment under test is always correctly fixtured and prepared for the most accurate results.

Available Tests:

- Contact resistance
- Dielectric withstanding voltage (DWV)
- Current rating
- Insulation resistance
- EMC shielding



TEMPERATURE / HUMIDITY TESTING

CLIMATIC (High Humidity - Constant)	
DAMP HEAT STEADY STATE	SPECIFICATION APPLICABLE
Temp. Range : +10°C to +90°C	BS EN / IEC 60068-2-3 EIA-364-31
Humidity Range : 10 to 98%rh	
Chamber Size: 690mmx600mmx610mm 500mmx610mmx500mm	
DAMP HEAT-CYCLIC	SPECIFICATION APPLICABLE
Temp. Range : +10°C to +90°C	BS EN / IEC 60068-2-30 EIA-364-59
Humidity Range : 10 to 98%rh	
Chamber Size : 650mmx500mmx600mm 800mmx600mmx500mm	
DAMP DRY COLD	SPECIFICATION APPLICABLE
Min Temp : -75°C	BS EN / IEC 60068-2-1 EIA-364-59
Max chamber size : 800mmx600mmx500mm	

Temperature and Humidity Testing is performed using industry-standard and IEC accepted practices of temperature cycling and humidity exposure. New and high-quality testing equipment ensures accurate results.

Available Tests:

- Dry heat
- Dry cold
- Damp heat steady state
- Damp heat cyclic
- Thermal shock



TEMPERATURE / HUMIDITY TESTING

CLIMATIC (High Temperature-Constant)	
TEMPERATURE-DRY HEAT	SPECIFICATION APPLICABLE
Maximum Temp : +300°C	BS EN / IEC 60068-2-2 EIA-364-17
Chamber Size : 500mmx600mmx600mm	
THERMAL SHOCK	SPECIFICATION APPLICABLE
Temp. Range : -60°C to +300°C	BS EN / IEC 60068-2-14
Manual (two chambers method)	
CHANGE OF TEMPERATURE	SPECIFICATION APPLICABLE
Gradual in air	BS EN / IEC 60068-2-14
Maximum Temp : +180°C	
Minimum Temp : -75°C	
Maximum rate of change : -75°C to +180°C: 5°C/Min +180°C to -75°C: 2,5°C/Min	

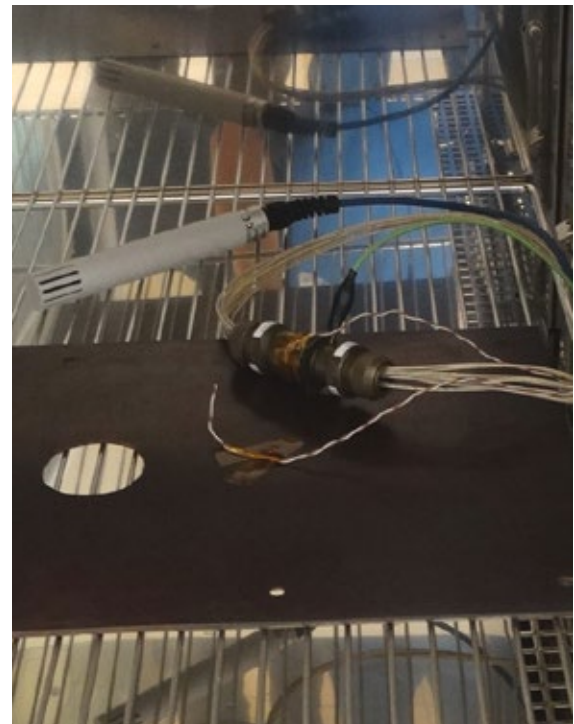

Salt Spray / Corrosion Testing

IEC QUALITY ASSESMENT SYSTEM FOR ELECTRONIC COMPONENTS (IECQ)



SALT SPRAY / CORROSION TESTS

CORROSION	
SALT/SO2 SPRAY (FOG)	SPECIFICATION APPLICABLE
Max chamber size : 500 Lt	BS EN / IEC 60068-2-11 EIA-364-26

Accelerated harsh-weather testing is performed to ensure components under test meet qualification requirements for galvanic corrosion and resistance, resistance to solvents, and SO2.

Available Tests:

- Salt spray/SO2
- Resistance to solvents



MISCELLANEOUS TESTS

MISCELLANEOUS	
TENSILE/COMPRESSION	SPECIFICATION APPLICABLE
Maximum load : 10KN	BS EN / IEC 60512-15-1 EIA-364-35
Manual	
FLUID CONTAMINATION	SPECIFICATION APPLICABLE
Immersion	BS EN / IEC 60068-2-45 EIA-364-10
WATERTIGHTNESS	SPECIFICATION APPLICABLE
Maxium pressure : 5 Bar	BS EN / IEC 60529
IP67, IP68	

Glenair testing facilities can perform additional qualification testing ranging from pull (tensile), compression, immersion, and hydrostatic pressure.

Available Tests:

- Low air pressure
- Tensile/compression
- Crimp graduation
- Sealing
- Hydrostatic pressure



MEASUREMENT PARAMETER AND RANGE		LABORATORY LIMITS (+/-)
DC VOLTAGE	1mV-1,5kV	0,20%
AC VOLTAGE	10mV-12kV (50Hz)	1,50%
DC CURRENT	>40mA-10A	1,00%
	10A-2000A	0,50%
AC CURRENT	10A- 700A (50Hz)	0,50%
DC RESISTANCE	>20mOhm-200kOhm	0,10%
	>100MOhm-1TOhm	3,00%
TEMPERATURE	-75C to 300C	0,40%
FORCE	0.1N-10kN	2,00%
TORQUE	0.Nm-5.0Nm	5,00%
HUMIDITY	10%rh-98%rh	5,00%

IEC QUALITY ASSESTMENT SYSTEM FOR ELECTRONIC COMPONETS (IECQ)

IEC QUALITY ASSESSMENT SYSTEM FOR ELECTRONIC COMPONENTS (IECQ)

Certificate of Approval of Independent Test Laboratory

Registration Number: T598257 IECQ Issue Number: 1 Page 1 of 2

of: **Glenair Italia S.p.A.**

at their place(s) of work:

Via Del Lavoro 7
Quarto Inferiore
Granarolo dell'Emilia
Bologna
40057
Italy

The organization, facilities and procedures have been assessed and found to comply with the applicable requirements for Independent Testing Laboratory approval, in support of the IECQ system, which is in accordance with the Basic Rules IECQ 01 and Rules of Procedure IECQ 03-6 "Independent Testing Laboratory Assessment Program Requirements" of the IEC Quality Assessment System for Electronic Components (IECQ) and applicable requirements of ISO/IEC 17025:2005 for the testing of electronic components under the IECQ. The scope of approval is as defined in the abstract to this certificate.

Signed on behalf of BSI: Date of Issue: 07 November 2013

IECQ Certification Body Date of Expiry: 06 November 2016

NOTE: This certificate is valid only in conjunction with the approved document(s).
The certificate may be suspended or withdrawn in accordance with the Rules of the International Electrotechnical Commission (IEC) implemented in BS 5900 Part 1.
This certificate remains the property of BSI Standards Institution and shall be returned immediately upon request.

Contact BSI: BSI Standards Central, 9000 Great West Road, Uxbridge, Middlesex UB8 3PH, UK.
BSI Registered in England, registered in England under company number 2010312. BSI is a limited liability company, registered in England, UK. A member of the BSI Group of companies.

IEC QUALITY ASSESSMENT SYSTEM FOR ELECTRONIC COMPONENTS (IECQ)

Abstract of Testing Facilities

Description of Facilities as recorded on the IECQ on-line database (www.iecq.org)

Registration Number: T598257 IECQ Issue Number: 1 Page 2 of 2

Test Laboratory: **Glenair Italia S.p.A.**

CONDITIONING TESTS		
ENVIRONMENTAL BS EN 60068 / IEC 60068		
Shock	Test A	00068-2-1
Dry Heat	Test B	00068-2-2
Damp Heat - Steady State	Test Ca	00068-2-28
Damp Heat - Cyclic	Test Db	00068-2-30
Change of Temperature	Test N	00068-2-34
Salt Mist	Test Ka	00068-2-31
MECHANICAL		
Vibration, sinusoidal	Test Fc	00068-2-6
Vibration, random	Test Fh	00068-2-64
Shock	Test Ea	00068-2-27
CONNECTORS FOR ELECTRONIC EQUIPMENT BS EN 60512 / EN 60512		
Contact Resistance	Test 2a	93 EN 60512-2-1
	Test 2b	93 EN 60512-2-2
HOUSING (CASE) ELECTRICAL		
Conductivity	Test 2f	93 EN 60512-2-6
Insulation Resistance	Test 3a	93 EN 60512-3-1
Voltage Proof	Test 4a	93 EN 60512-4-1
Temperature Rise	Test 5a	93 EN 60512-5-1
Current Temperature	Test 5b	93 EN 60512-5-2
Smoking Effectiveness IEC EN IECQ 02/15-3-7		

MEASUREMENT CAPABILITIES (Parameters)
DC Voltage, DC Current, AC Voltage, AC Current, DC Resistance, Temperature, Humidity.

ELECTRICAL PRODUCT TESTS
Resistors, Printed Circuits, Switches, Relays, Connectors, Transformers, Electrical Harnesses









NOTE: This certificate is valid only in conjunction with the approved document(s).
The certificate may be suspended or withdrawn in accordance with the Rules of the International Electrotechnical Commission (IEC) implemented in BS 5900 Part 1.
This certificate remains the property of BSI Standards Institution and shall be returned immediately upon request.

Contact BSI: BSI Standards Central, 9000 Great West Road, Uxbridge, Middlesex UB8 3PH, UK.
BSI Registered in England, registered in England under company number 2010312. BSI is a limited liability company, registered in England, UK. A member of the BSI Group of companies.

For any query or additional information about the Glenair Independent Environmental Test Laboratory, please contact the manager Pierpaolo Brulatti directly at +39-051-782811 or by email: pbrulatti@glenair.it

QwikConnect Bonus Feature: New Product Showcase

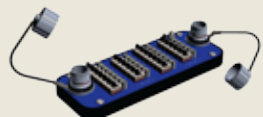
TABLE OF CONTENTS

	EI Ochito™: the ultimate Ethernet connector	Page 24
	Opto-Electronic media converters for Ethernet and other high-speed applications	Page 26
	Series 824 Locking Push-Pull for ruggedized environmental applications	Page 28
	Series 841, 844, and 845 Stinger™ contact equipped Mighty Mouse connectors for high-density applications	Page 30
	Band-Master™ ATS Slim Standard EMI shield termination banding system: 50% lighter than standard bands	Page 32
	MasterLatch Series GMLM thumb-lock and release Micro-D connector	Page 34
	Mighty Mouse Breakout Board for on-site field testing	Page 36
	MIL-DTL-24749 Type IV US Navy-Qualified Ground Straps for harsh corrosion environments	Page 40
	Digital Torque Wrench and Bench Mount Stand for reliable high-volume connector-to-backshell assembly and torque measurement	Page 42

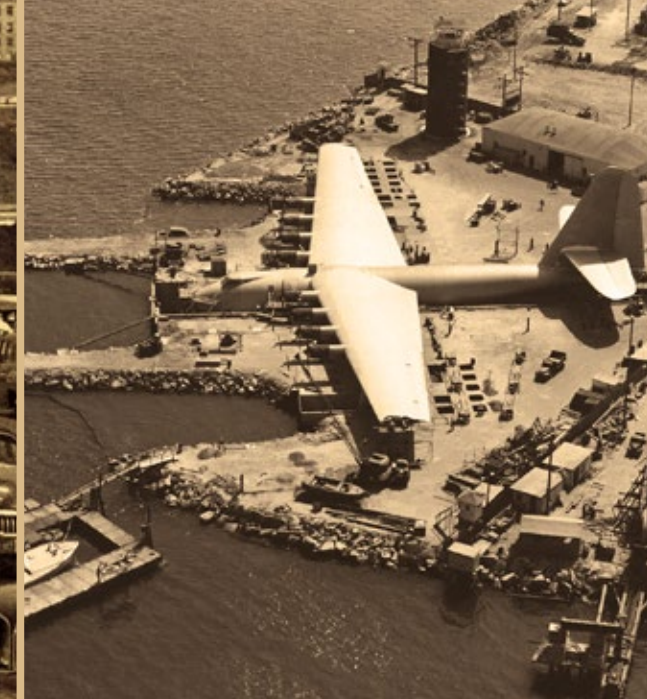

At home in Southern California *since 1956*



Can you identify these iconic Southern California images?
Answers online May 15, 2014
www.glencair.com/qwikconnect

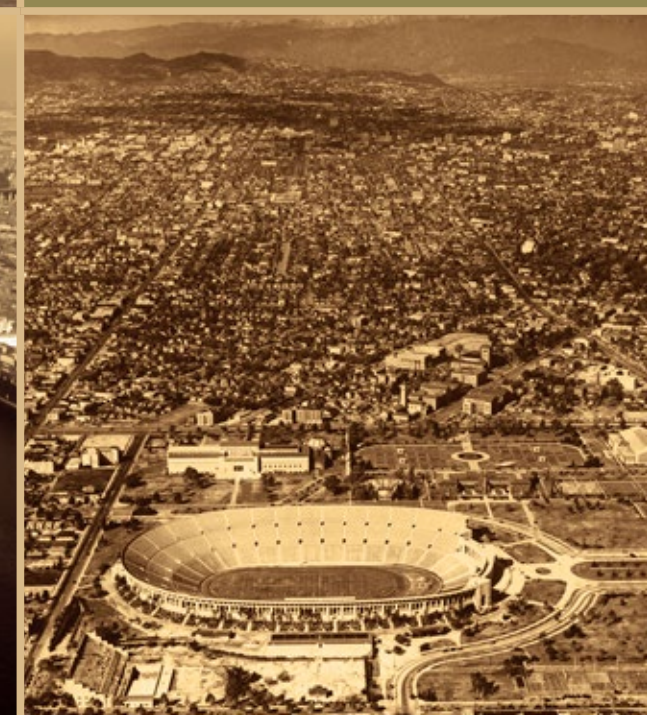



El Ochito™: The Ultimate Ethernet Contact

“The Little Eight”: Eight miniaturized contacts in a standard size #8 shielded module—10G Ethernet ready, with dramatic size and weight reduction compared to all other available solutions

- One full Ethernet channel per standard size #8 cavity
- Fast and easy crimp termination of wires to contacts—PC Tails available
- 100% drop-in solution to installed connectors—no redesign or reinstallation of interfaces
- Supplied as crimp contacts, wire pigtailed, or in PC tail configurations in the connector of your choice—up to 8 Ochito modules in a size #25 D38999
- Integral spline and short termination maximizes interconnect/cable performance and minimizes crosstalk
- El Ochito™ delivers the highest density contact system available—twice the density of Quadrax, split Quadrax, or other shielded contact solutions
- Tested, qualified, and in-stock for immediate shipment

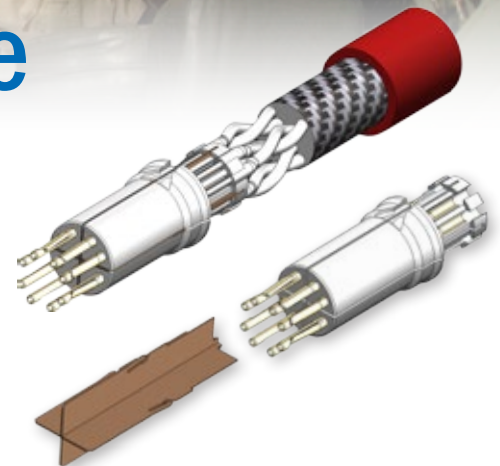

El Ochito™ exploded view: High mating durability, lightweight contact system with 100 Ohm shielded performance. Note wire twist maintained to contact pair to minimize characteristic impedance mismatch. Also, Conductive isolation shield dramatically reduces crosstalk



El Ochito™ is a drop-in solution for Series 80 Mighty Mouse, as well as D38999 Series III, EN4165, EN3645, and other ARINC standards and is ideally suited for Ethernet, high-definition video, high-speed data loading, and other 1Gb/sec and 10Gb/sec applications.

El Ochito™: The Ultimate Ethernet Contact



Specifications and ordering

How-To-Order El Ochito™ Contacts	
858-003 Size 8 Ochito 26-AWG crimp or solder Pin	858-004 Size 8 Ochito 26-AWG crimp or solder Socket



El Ochito™ utilizes Stinger™ contact technology. These small, durable, low mating force contacts provide El Ochito™ with optimized performance.

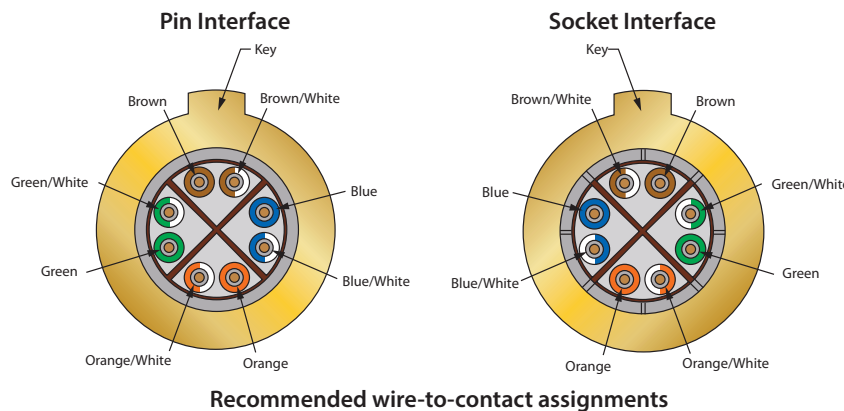

Contact Performance Specifications	
Temperature Range	-55°C to +175°C
Environmental Sealing	IAW connector specification
Corrosion Resistance	48 hours salt spray
Fire, Smoke and Toxicity	IAW FAR 25
EMI Shielding	360° shielding for each pair
Nominal Current	1 Amp
Contact Resistance	Max 60 milliohms
Wire	IAW TIA/EIA Cat 6A and ISO Ea
Mating Cycles	> 500
DWV	500 VAC RMS sea level

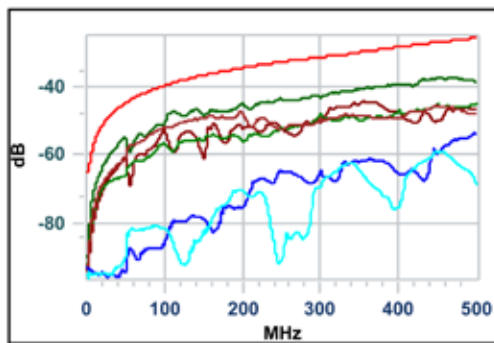

Near End Crosstalk · Cat 6a · 500 MHz

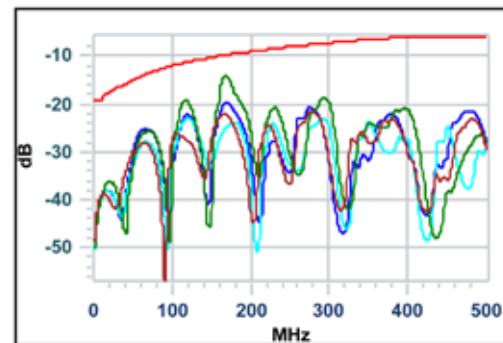

Return Loss · Cat 6a · 500 MHz

GLENAIR SUPPLIED CABLE FOR OCHITO APPLICATIONS 963-003-26

CABLE PHYSICAL DATA

- Conductors: 26AWG stranded SPC
- Shield coverage: 80% (braid)
- Temperature: -55°C to +200°C
- Outer diameter: 0.220 (5.588mm)
- Minimum bend radius: 1.13 (78.702mm)
- Weight (lbs/100 ft): 3.05 (4.54 kg/100m)

CABLE CONSTRUCTION

1. White PTFE laser-printable jacket
2. Silver-plated copper shield
3. Fluoropolymer tape
4. PFA insulation
5. Fluoropolymer spline
6. Silver-plated copper conductors

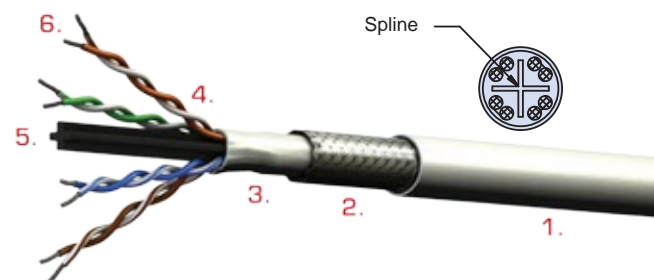



Technology can be integrated into mil-standard connectors or ruggedized packaging to suit any application

HARSH-ENVIRONMENT Opto-Electronic Interconnect Solutions

Protect fiber interfaces from harsh environments and reduce the size and weight of fiber optic interconnect systems

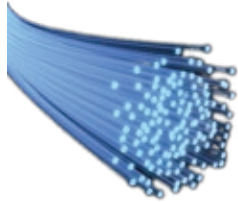

Virtues of Fiber Optics: reduced weight, increased distance, expanded bandwidth, and EMI immunity.

Problems with Fiber Optics: difficult to terminate, requires optical to electrical conversion, complex maintenance and repair, and may experience performance problems in harsh environments.



Advantages of Active Opto-Electronic technology: leverages the advantages of fiber media, reduces the complexity of fiber optic systems, and excels in harsh application environments.

ADVANTAGES OF OPTO-ELECTRONICS

- **Trouble-free conversion from copper to fiber optic media for expanded bandwidth, reduced size and weight, improved network security and virtual EMI/RFI/EMP immunity**
- **Environmentally sealed (water-tight) in the mated condition**
- **Designed to resist aerospace-levels of mechanical shock and vibration**
- **Operating temperature ranges of -40°C to +85°C and beyond**
- **In-house, vertical integration for all circuit design and component and subsystem manufacturing**
- **Responsive and experienced application development and engineering team**

SIZE 8 OPTO-ELECTRONIC CONTACTS



Patent Pending

The Size 8 Cavity Opto-Electronic contacts transmit and receive differential CML electrical signals over Multimode fiber optic cable. Transmitters consist of a laser driver with a temperature compensation circuit to maintain optical power over the entire operating temperature range, and a 850nm VCSEL laser. Receivers consist of an 850nm PIN Photo Detector, a Transimpedance Amplifier with automatic gain control circuit, and a Limiting Amplifier. Differential output data signals are CML compatible.

PCB-MOUNT TRANSCEIVERS



Glenair PCB mount transceivers are ruggedized harsh-environment equivalents to SFP transceivers but with mechanical design suited to the harsh temperature and vibration environments found in Military and Aerospace applications. PCB mount optical transceivers support optional Digital Monitoring Interface (DMI) features in accordance with SFF 8472. The Transceiver is comprised of a transmitter section and a receiver section that reside on a common package and interface with a host board through a high speed electrical connector.

ACTIVE CONNECTORS



Glenair active connectors incorporate an opto-electronic transceiver that converts electrical signals to multimode fiber. The transmitter section incorporates a laser and laser driver with APC functionality to maintain output power and extinction ratio over the operating temperature range. The Glenair optical transceiver is ideal for harsh-environment, extreme shock, vibration and temperature avionics and military applications where copper cable link distance, bandwidth, weight or bulk make the use of twisted pair, twinax or quadrx copper conductors unacceptable.

ETHERNET AND DVI MEDIA CONVERTERS



Glenair Media Converters use state-of-the-art opto-electro-mechanical technology to provide harsh environment Ethernet and DVI interconnect solutions that enable much longer distances than copper cables. Media Converters use rugged aerospace-grade electrical connectors and incorporate electrical to optical (E/O) and optical to electrical (O/E) conversion, voltage regulation, and signal conditioning in the backshell to enable compact electrical to fiber optic media conversions for harsh environments.

ETHERNET SWITCHES



The Glenair unmanaged Ethernet switch is a seven 10/100/1000BASE-T port layer 2 switch with Auto negotiation and Auto MDI / MDIX circuitry that enables up to 6x port expansion with IEEE-802.3U 10/100/1000BASE-T Ethernet ports. Developed for use in harsh environment applications, the electronics are incorporated into a panel-mountable housing that is sealed against liquid and solid contaminants and designed for shock and vibration resistance. Connector interface is a high-performance size- and weight-saving Glenair Series 805 Mighty Mouse jam nut receptacle connector.

SIGNAL AGGREGATORS



Glenair signal aggregators integrate a set of compact opto-electronic modules to digitize and/or aggregate multiple common signal types, and combine them onto high-data-rate serial optical fiber channels. The technology leverages the high bandwidth of optical fiber by multiplexing many lower-data-rate signals onto a few fibers. Silicon field-programmable gate array (FPGA) technology provides a flexible way to accommodate many signal I/O types, and one high-speed opto-electronic interface serves practically all signal types.



SERIES 824

Mighty Mouse

Locking push-pull connectors

Introducing the new Mighty Mouse Series 824 Locking Push-Pull Connector: all the familiar size, weight and performance advantages of the industry-standard Mighty Mouse 804 push-pull connector with a revolutionary low-profile locking coupling mechanism. Glenair's primary design goal in the development of the locking 824 was to bring mil-spec caliber connector performance to locking push-pull applications. The Series 824 Locking Push-Pull provides superior sealing, excellent EMI protection, low-profile ergonomic mating and demating, and easy crimp contact termination. The locking push-pull mechanism delivers visual, tactile, and audible mating confirmation under even the most extreme field conditions. Built for long-term durability and reduced size and weight, the high-density Series 824 Locking Push-Pull connector far surpasses commercial caliber push-pull connectors.

- Fast mating, quick-release coupling mechanism
- 31 insert arrangements
- Integral cable shield termination platform

Specifications	
Current Rating	#23 5 AMPS, #16 13 A., #12 23 A.
Dielectric Withstanding Voltage	#23 500 VAC RMS, #12 and #16 1800 VAC RMS
Insulation Resistance	5000 megohms minimum
Operating Temperature	-65° C to +150° C
Shock / Vibration	100 g / 16 g
Shell-to-Shell Resistance, Nickel Plated	2 milliohms maximum
Durability	2000 mating cycles
Breakaway Force	50 pounds minimum



Gold plated crimp contacts for #12 to #30 AWG wire

SERIES 824 Mighty Mouse Locking push-pull connectors

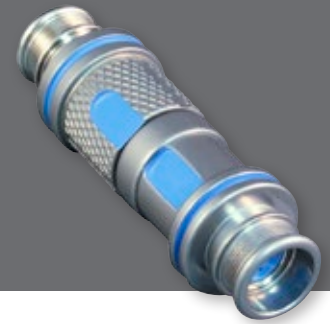

How To Order Series 824 Locking Push-Pull Plug						
Sample Part Number	824-001	-06	M	8-1	P	A
Product Series	824-001 Mighty Mouse Locking Push-Pull cable plug with integrated shield termination platform					
Shell Style	-06 - Plug					
Shell Material/Finish	See Table II					
Shell Size/Contact Arrangement	See Table I					
Contact Type	Connector supplied with contacts: P - Pin S - Socket			Connector supplied without contacts: A - Pin B - Socket		
Shell Key Position	Omit for single polarizing key. A (normal), B, C, D, E, F polarizing options per Table III					

How To Order Series 824 Locking Push-Pull Receptacle						
Sample Part Number	824-003	-01	M	8-1	P	A
Product Series	824-003 Mighty Mouse Locking Push-Pull cable plug with integrated shield termination platform					
Shell Style	-01 - In-Line -07 - Rear-Panel Jam Nut Mount -00 - Front-Panel Jam Nut Mount					
Shell Material/Finish	See Table II					
Shell Size/Contact Arrangement	See Table I					
Contact Type	Connector supplied with contacts: P - Pin S - Socket			Connector supplied without contacts: A - Pin B - Socket		
Shell Key Position	Omit for single polarizing key. A (normal), B, C, D, E, F polarizing options per Table III					

Table I: Contact Arrangements					
Contact Arr.	No. of Contacts				
	#23	#20	#20HD	#16	#12
5-3	3				
6-1				1	
6-23			3		
6-4	4				
6-6	6				
6-7	7				
7-1					1
7-25			5		
7-10	10				
8-2				2	
8-28			8		
8-13	13				
8-200	4	2			
9-4				4	
9-210			10		
9-19	19				
9-200	4			2	
9-201	8	2			
10-2					2
10-5				5	
10-26	26				
10-200	12				1
10-201	4				2
10-202	8			2	
12-2					2
12-3					3
12-7				7	
12-220			20		
12-37	37				
12-200	6				2
12-201	10				2

Table III: Alternate Key Positions		
Position	A°	B°
A	150°	210°
B	45°	210°
C	45°	230°
D	140°	315°
E	150°	315°

Table II: Material and Finish	
M	Aluminum/Electroless Nickel RoHS Compliant
NF	Aluminum/Cadmium with Olive Drab Chromate
ZR	Aluminum/Zinc-Nickel with Non-Reflective Black Chromate RoHS Compliant
MT	Aluminum/Nickel-PTFE RoHS Compliant
Z1	Stainless Steel/Passivated RoHS Compliant

MATERIAL/FINISH

Barrel: Copper Alloy
 Shell/Release Sleeve: Aluminum Alloy or CRES
 Insulators: Liquid Crystal Polymer
 Interfacial Seal, O-Ring, Grommet: Fluorosilicone
 Contacts: Copper Alloy/Gold over Nickel Plating
 Spring: CRES/Gold Plated



For more information
 contact Glenair at
818-247-6000 or
 visit our website at
www.glenair.com
 U.S. CAGE code 06324

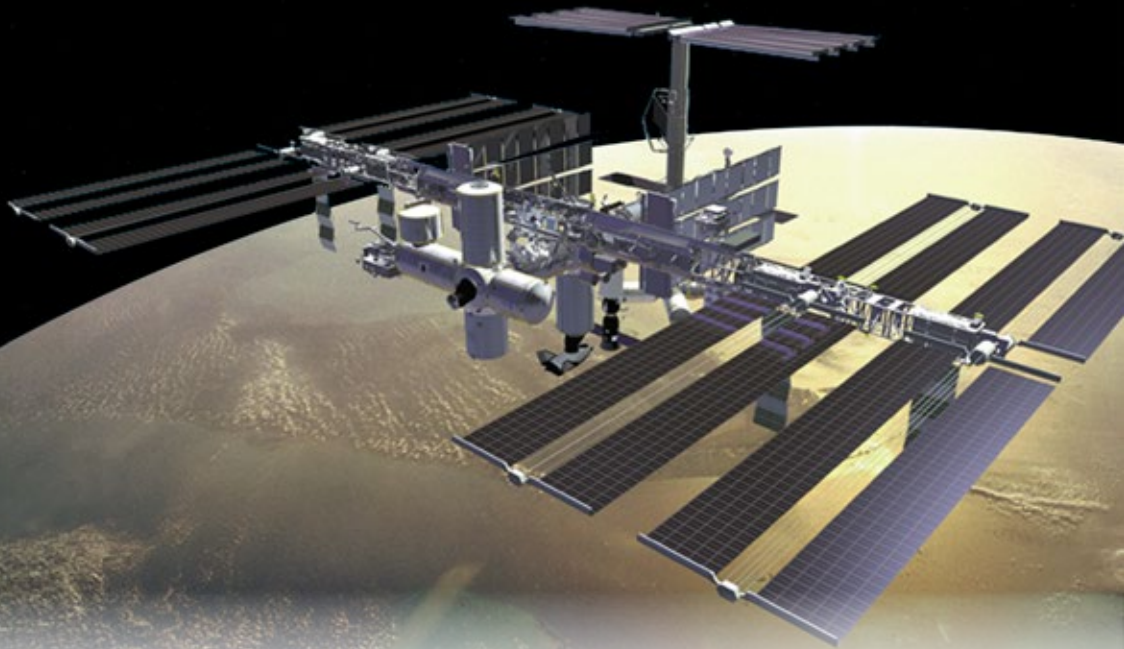

SERIES 841, 844 AND 845 High-Density Stinger™ Equipped Mighty Mouse Connectors

The Glenair size #28 Stinger™ contact system is now available for series 801, 804 and 805 connectors for applications that require high density (.050" center) insert arrangements with convenient front-release crimp-contact termination. Stinger™ contacts accommodate a wire range from 30-24 AWG and feature an integrated O-ring seal and retention clip. Unlike the Glenair Series 811 High-Density solution with its pot-in-place TwistPin contacts, Stinger™ crimp removable contacts allow users to terminate cables, populate connectors and build high-density wire harnesses in-house.

- Front-release crimp contact solution
- High-density .050" centers
- Integrated retention clip and o-ring sealing
- Available for Series 801 (threaded stub-ACME), 804 (push-pull) and 805 (triple-start) connectors
- Stinger™ contacts meet all applicable requirements of SAE AS39029
- Low mating force, 1/3 insertion force of typical fixed Micro-D twist pin

Plug Cross-Section (841 shown)

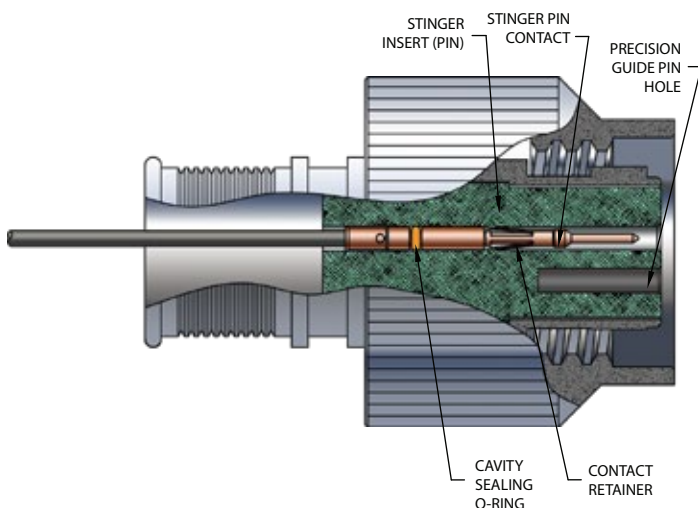

Receptacle Cross-Section (841 shown)

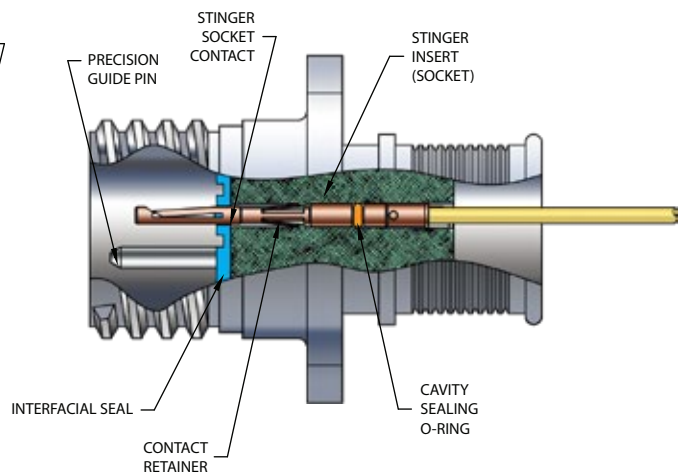

SERIES 80 MIGHTY MOUSE Stinger™ Equipped Connectors



CONTACTS SOLD SEPARATELY

How-To-Order			
Part No.	Description	Part No.	Description
850-200	Size #28 Crimp Stinger™ Pin Contact	850-201	Size #28 Crimp Style Stinger™ Socket Contact

CONTACT/CONNECTOR PERFORMANCE

Product Specification (Series 844 push-pull shown)			
Insulation Resistance	5,000 Megohm Min.	Durability	2000 cycles
Dielectric Withstanding Voltage	500 VAC at sea level	Contact Retention	2 lbs. axial force
Low Level Contact Resistance	50 milliohms Max per AS39029	Contact Engagement Force	3.6 ounces Max
Contact Resistance	54 millivolts Max per AS39029	Contact Separation Force	0.4 ounces Min
Current Carrying Capacity	1.5 Amps	Please consult factory for higher current carrying capacity	

AVAILABLE INSERT ARRANGEMENTS

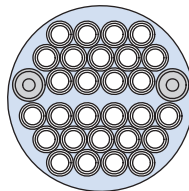
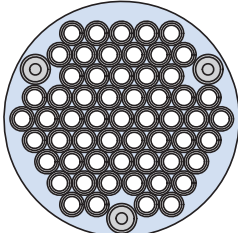
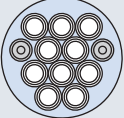
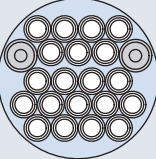
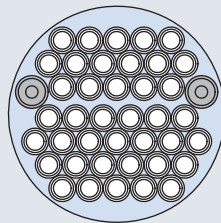
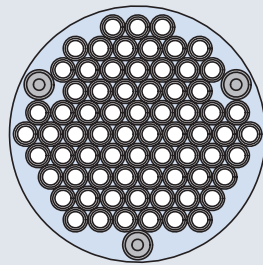
Insert Arrangements								
 <p>(2x Guide Pins)</p>	Series 841	5-5: 5x #28 Contacts	 <p>(2x Guide Pins)</p>	 <p>(3x Guide Pins)</p>				
	Series 844	5-5: 5x #28 Contacts			Series 841	10-58: 58x #28 Contacts		
	Series 845	N/A			Series 844	10-58: 58x #28 Contacts		
 <p>(2x Guide Pins)</p>	Series 841	6-10: 10x #28 Contacts	Series 841	10-28: 28x #28 Contacts	Series 841	10-58: 58x #28 Contacts		
	Series 844	6-10: 10x #28 Contacts	Series 844	8-28: 28x #28 Contacts	Series 844	10-58: 58x #28 Contacts		
	Series 845	8-10: 10x #28 Contacts	Series 845	10-28: 28x #28 Contacts	Series 845	12-58: 58x #28 Contacts		
 <p>(2x Guide Pins)</p>	Series 841	7-20: 20x #28 Contacts	 <p>(2x Guide Pins)</p>	 <p>(3x Guide Pins)</p>				
	Series 844	7-20: 20x #28 Contacts			Series 841	9-40: 40x #28 Contacts	Series 841	11-71: 71x #28 Contacts
	Series 845	9-20: 20x #28 Contacts			Series 844	11-40: 40x #28 Contacts	Series 844	11-71: 71x #28 Contacts
			Series 845	13-40: 40x #28 Contacts	Series 845	13-71: 71x #28 Contacts		



SERIES 601
**Slim Standard
 Band-Master™ ATS**

Up to 50% weight savings
 compared to standard shield
 termination bands

- Lightweight gauge band with 150 lbs. cable pull strength
- Reliable, proven shield termination technology
- One tool to complete all operations—now with calibration counter
- 50% lighter weight and lower profile compared to standard bands with similar performance

MANUAL BANDING TOOL WITH CALIBRATION COUNTER FOR SLIM STANDARD BANDS



Color-coded tensioning lever: orange = slim standard

**For Slim Bands 601
 -570, -571, -572 and -573**

The 601-109 Slim Band-Master™ ATS Tool weighs 1.2 lbs., and is designed for slim standard flat .24" width clamping bands (601-570, 601-571, 601-572 and 601-573) in a tension range from 50 to 100 lbs. Calibrate at 100 lbs. ± 5 lbs. for most shield terminations. Tool and band should never be lubricated.

Cable Pull Strength for Slim Standard Bands					
Name	Material Type	Band Width	Material Thickness	Tool Setting	Cable Pull Strength
Slim Standard	300 Series SST	0.240"	.010"	100 lbs. ± 5 lbs.	150 lbs.

Weight reduction shield termination solution

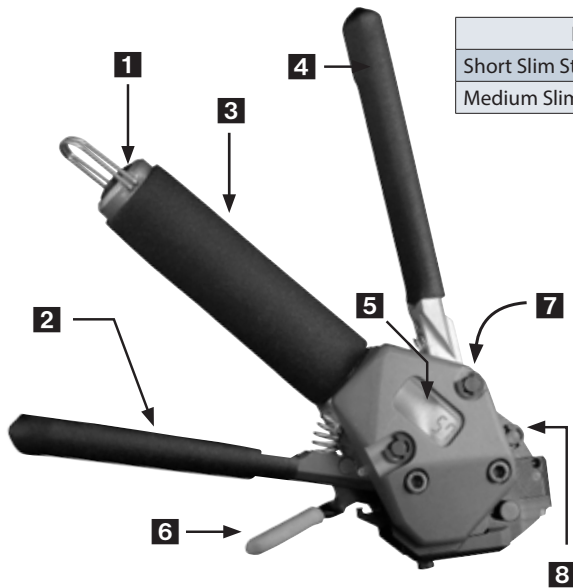

Bands	Band-Master™ ATS Band Selection					
	Length		Part Number		Fits Diameter	
	in.	mm.	Flat	Pre-Coiled	in.	mm.
Short Slim Standard Band	9.0	228.6	601-570	601-571	1.0	25.4
Medium Slim Standard Band	14.25	362.0	601-572	601-573	1.8	47.8

1 Calibration Access Plug

2 Tensioning Lever (orange color on 601-109 Slim Standard tool): Squeeze with short gentle strokes to tighten band to the proper tension. Lever will lock to **3 Handle** with final full stroke.

4 Cut-Off Lever: Squeeze to lock band buckle and trim excess band material.

5 Calibration Counter for improved quality assurance

6 Band Insertion and Release Lever: Depress lever to insert or release band from tool.

7 Serial Number

8 Tension Release Lever



SLIM STANDARD BANDS

Short Flat 601-570

Short Precoiled 601-571

Slim Standard Bands are 50% lighter and 50% lower-profile than standard bands. They are precision constructed of work hardened, 300 Series SST for improved performance. Short slim bands are 9.00 inches (228.6) in length and designed for use with the 601-109 Band-Master™ ATS hand banding tool or the 601-110 pneumatic tool. Bands should always be double wrapped and will accommodate diameters up to approximately .94 inches (23.9).

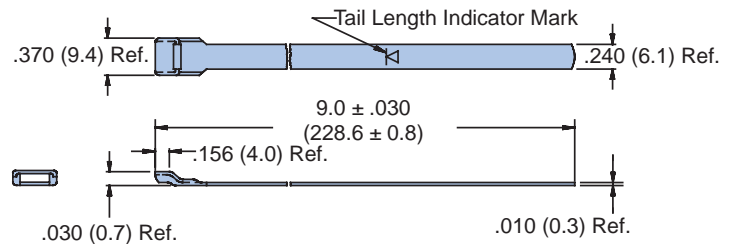

Medium Flat 601-572

Medium Precoiled 601-573

Slim Standard Bands are 50% lighter and 50% lower-profile than standard bands. They are precision constructed of work hardened, 300 Series SST for improved performance. Medium slim bands are 14.25 inches (362.0) in length and designed for use with the 601-109 Band-Master™ ATS hand banding tool or the 601-110 pneumatic tool. Bands should always be double wrapped and will accommodate diameters up to approximately 1.8 inches (45.7).

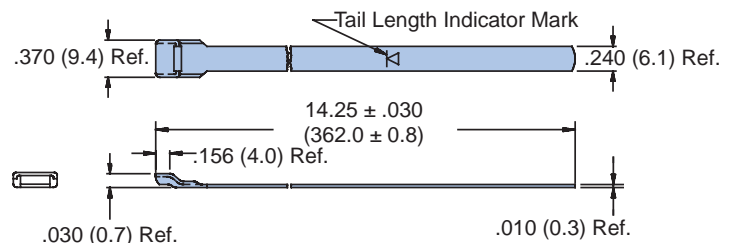



SERIES GMLM

MasterLatch™

QUICK-DISCONNECT MICRO-D

MasterLatch (GMLM) Quick-release locking Micro-D connector pairs are equipped with a precision latching and locking mechanism. The single thumb latch on the plug side actuates a pair of locking latches that mate quickly and reliably to GMLM receptacles. These TwistPin equipped, low-insertion-force connectors meet all the standard performance requirements of MIL-DTL-8513 including vibration, shock, and mating durability. Choose from 7 different insert arrangements from 9 to 51 way. The unique ergonomic latching mechanism can be easily activated with a thumb and forefinger grip even when wearing gloves, or when difficult access to connector pairs makes the use of jacking hardware and tools impossible.



- Precision latch meets MIL-DTL-8513 vibration and shock
- Low insertion force TwistPin contacts
- Easy-to-activate latching mechanism

Face view pin connector - Micro-D contact arrangements

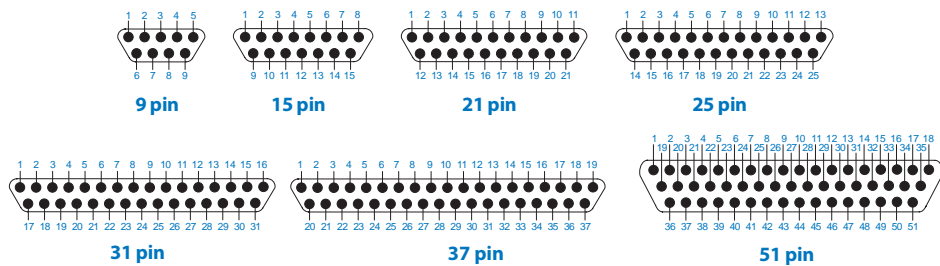

For more information contact Glenair at 818-247-6000 or visit our website at www.glenair.com

SERIES GMLM

MasterLatch™

QUICK-DISCONNECT MICRO-D

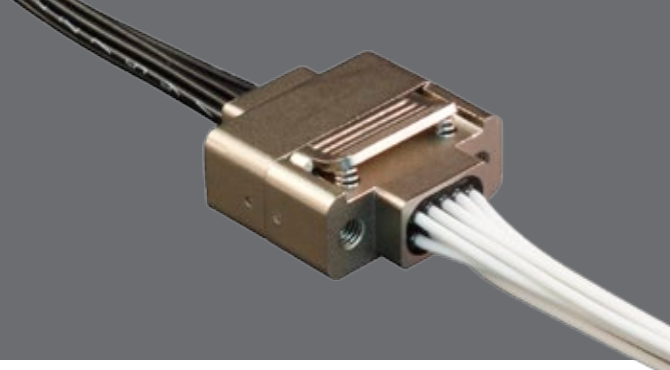

How To Order GMLM MasterLatch™									
Sample Part Number	GMLM	2	L	-25	P	-6	K	7	-18
Product Series	GMLM Glenair MasterLatch™ Micro-D								
Shell Plating	1 - Cadmium 2 - Nickel 4 - Black Anodize 5 - Gold 6 - Chem Film								
Insulator Material	L - LCP or PPS								
Contact Layout	9, 15, 21, 25, 31, 37, 51								
Connector Type	P - Pin Connector S - Socket Connector								
Wire Gauge	4 - 24 AWG 6 - 26 AWG 8 - 28 AWG 0 - 30 AWG (30 AWG-Lab Only)								
Wire Type	K - M22759/11 600 Vrms Teflon (TFE) J - M22759/33 600 Vrms Modified Cross-Linked Tefzel (ETFE)								
Wire Color Code	1 - White 2 - Yellow 5 - Color Coded 7 - Ten Color Repeating								
Cable Length In Inches	18 - 18 inches								

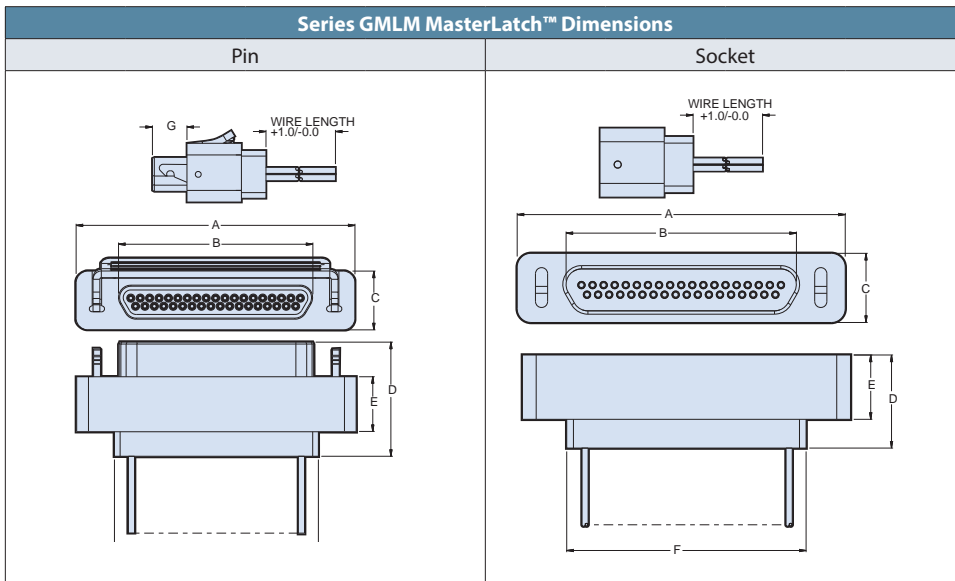

Layout	A Max	B Max	C	D Max	E Max	F Max	G
9P	0.785	0.333	0.320	0.610	0.290	0.400	0.183
9S	0.785	0.342	0.320	0.429	0.295	0.400	0.183
15P	0.935	0.483	0.320	0.610	0.290	0.550	0.183
15S	0.935	0.492	0.320	0.429	0.295	0.550	0.183
21P	1.085	0.633	0.320	0.610	0.290	0.700	0.183
21S	1.085	0.642	0.320	0.429	0.295	0.700	0.183
25P	1.185	0.733	0.320	0.610	0.290	0.800	0.183
25S	1.185	0.742	0.320	0.429	0.295	0.800	0.183
31P	1.335	0.883	0.320	0.610	0.290	0.950	0.183
31S	1.335	0.892	0.320	0.429	0.295	0.950	0.183
37P	1.485	1.033	0.320	0.610	0.290	1.100	0.183
37S	1.485	1.042	0.320	0.429	0.295	1.100	0.183
51P	1.435	0.983	0.320	0.610	0.290	1.050	0.183
51S	1.435	0.992	0.320	0.429	0.295	1.050	0.183

MasterLatch™ GMLM connectors are sold as prewired pigtailed only, with 18 inch wire leads. Contact factory for alternative lengths.

MATERIAL AND FINISH

- Insulator: Liquid crystal polymer or PPS
- Wire: M22759/11 600 Vrms Teflon (TFE) or M22759/33 600 Vrms Modified Cross-Linked Tefzel (ETFE)
- Pin Contacts: Gold-plated copper alloy
- Socket Contacts: Gold-plated phosphor bronze alloy
- Shell: Aluminum alloy with choice of cadmium plate, electroless nickel, black anodize, gold, or chem film
- Latching mechanism: Stainless steel



SERIES 245

Mighty Mouse Breakout Board

Rugged, reliable performance for on-site testing

The Glenair small form-factor 245-805 Mighty Mouse Breakout Board allows fast and reliable monitoring / testing of Unit Under Test (UUT) circuits and contacts during operation. The breakout board, equipped with switch technology instead of fragile plastic jumpers, is inserted between the UUT and the interconnect cable assembly to facilitate accurate debugging of intermittent failures / abnormal transient signals. Each breakout board is supplied with a rugged overmolded cordset that ensures test board durability in both laboratory and on-site testing.

- Switches offer improved durability and reliability over plastic jumpers
- .080" test points
- Circuit board is secured in a metal shell for strength and stability
- Supplied with a cable assembly to facilitate on-site testing
- Available for the complete range of Series 805 Mighty Mouse insert arrangements

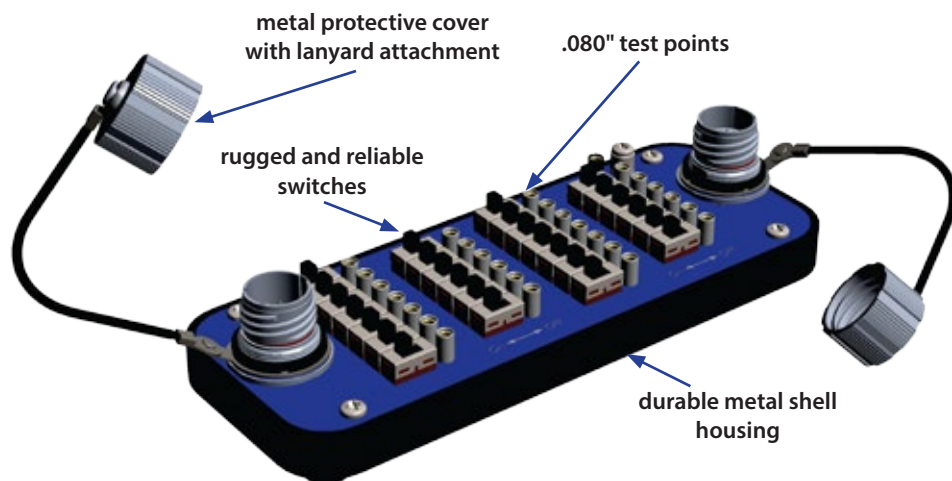

Glenair®

For more information contact Glenair at 818-247-6000 or visit our website at www.glenair.com

SERIES 245 Mighty Mouse Breakout Board for on-site testing



How To Order					
Sample Part Number	245-805	-NF	12-26	A	-36
Breakout Board	Series 805 Mighty Mouse				
Material/Finish	See Table I				
Connector Insert Arrangement	See Table II				
Connector Key Position	A, B, C, D, E, F (A=Normal)				
Cordset Length	In inches (12 In. min.) Omit = No cordset				

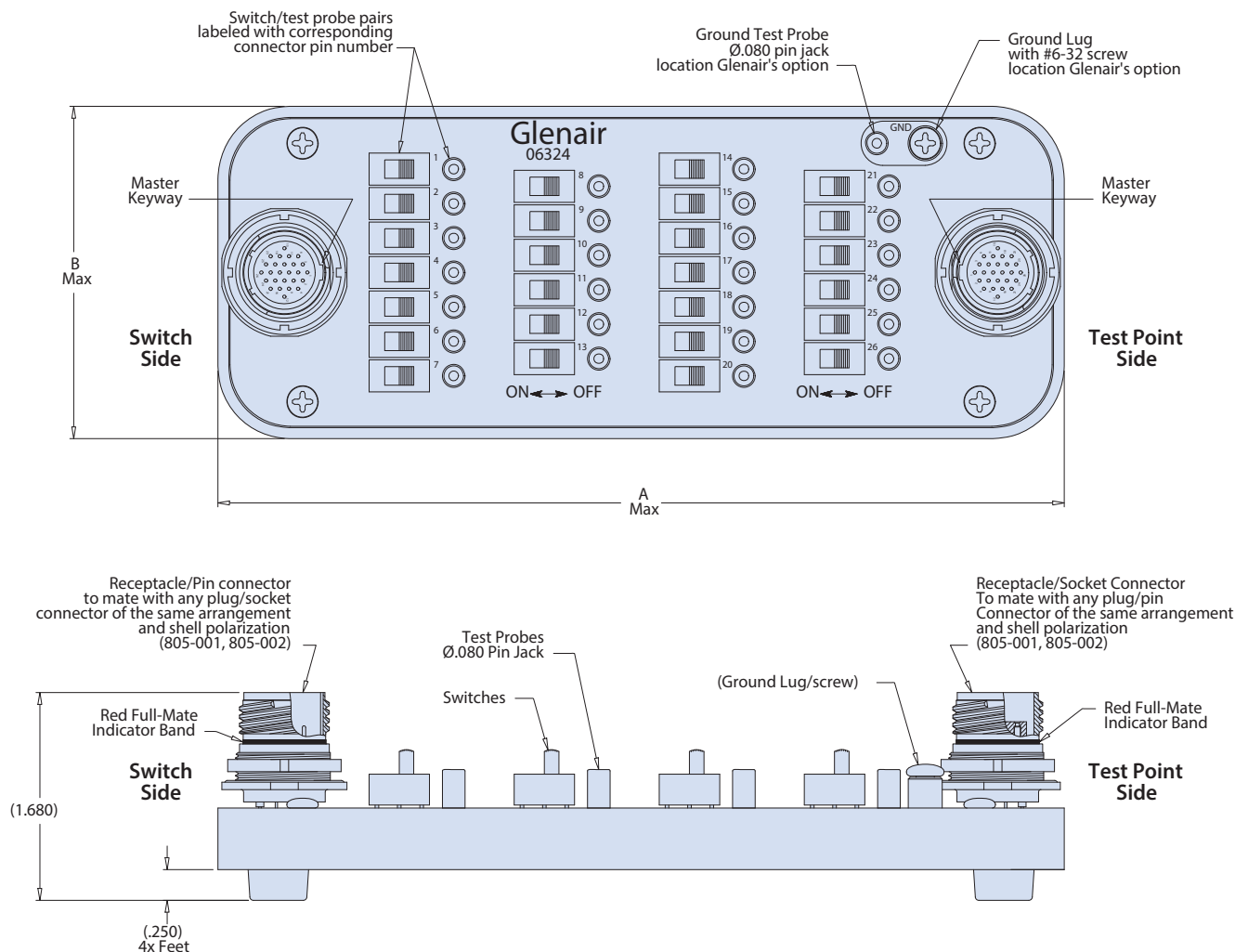

Table I: Material/Finish		
Class	Shell Material	Finish Description
M	Aluminum	Electroless Nickel
MT		Ni-PTFE 1000 Hour Grey
NF		Olive Drab Cadmium Over Electroless Nickel
ZN		Ninc-Nickel, Olive Drab
ZNU		Zinc-Nickel, Black
ZL	Stainless Steel	Electro-Deposited Nickel

Table III: Dimensions						
Board Size	A Max		B Max		Max Trace Length (PCB)	
	In.	mm.	In.	mm.	In.	mm.
2	4.000	101.6	2.250	57.2	4.0	101.6
3	5.250	133.4	2.250	57.2	7.0	177.8
4	7.250	184.2	3.000	76.2	10.0	254.0
5	7.500	190.5	3.750	95.3	13.0	330.2
6	8.500	215.9	5.500	139.7	18.0	457.2
7	9.500	241.3	6.750	171.5	20.0	508.0

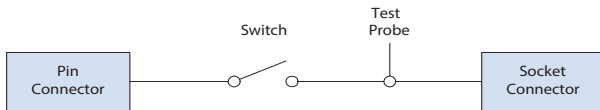
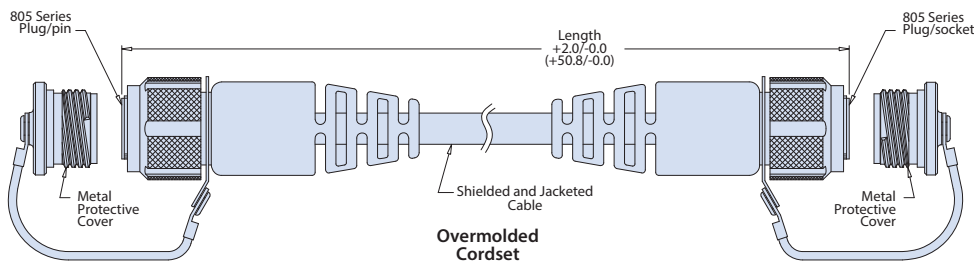
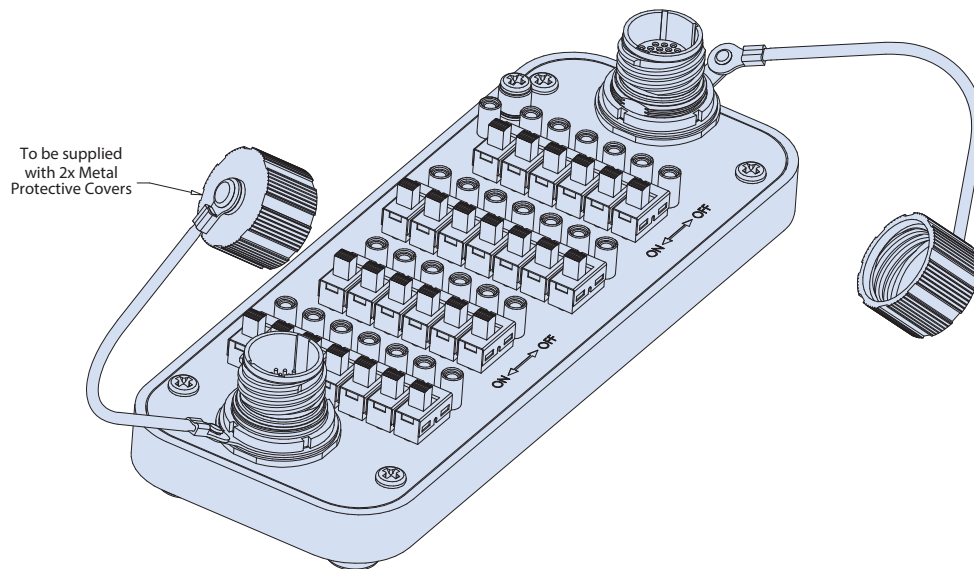

Table II: 805 Series Mighty Mouse Contact Arrangements							
Contact Size	Contact Quantity					Insert Arrangement	Board Size
	#23	#20	#20HD	#16	#12		
Size #23 Contacts	4					8-4	2
	6					8-6	2
	7					8-7	2
	10					9-10	2
	13					10-13	2
	19					11-19	3
	26					12-26	4
	31					13-31	4
	37					15-37	4
	55					18-55	5
Size #20HD Contacts	85					19-85	6
	100					21-100	6
	130					23-130	7
			3			8-23	2
			5			9-25	2
			8			10-28	2
			10			11-210	2
			20			15-220	3
			35			18-235	4
			41			19-241	5
Size #16 Contacts				1		8-1	2
				2		10-2	2
				4		11-4	2
				5		12-5	2
				7		15-7	2
				12		18-12	3
				14		19-14	3
				19		21-19	4
Size #12 Contacts				22		23-22	4
					1	9-1	2
					2	12-2	2
					2	15-2	2
					3	15-3	2
					5	18-5	2
					7	19-7	2
Mixed Size "Combo" Layouts					12	23-12	3
	4	2				10-200	2
	8	2				11-201	2
	4			2		11-200	2
	8			2		12-202	2
	4				2	12-201	2
	6				2	15-200	2
10				2	15-201	2	
12				1	12-200	2	

SERIES 245 Mighty Mouse Breakout Board for on-site testing



Series 245 Breakout Board Performance Specifications	
Temperature Rating	-30°C to +85°
Current Rating	5A Max
DWV	300 VDC
Insulation Resistance	5 Gighms Min @ 200 VDC
Note: Although the PCB traces and components used are capable of withstanding high voltage/current, use caution to avoid exposure to any lethal levels. Not intended for handheld use at voltages above 33 VRMS/70 VDC.	



MATERIAL/FINISH

- Connector Seals - Fluorosilicone
- Connector Contacts - Copper Alloy/Gold Over Nickel per ASTM B488
- Housing - Aluminum Alloy/Black Anodized
- Circuit Board - FR4 Epoxy Glass/Gold or HASL Plated Solder Pads
- Test Probe Contact - Copper Alloy/Silver Plating
- Hardware - Stainless Steel/Passivated
- Feet - Thermoplastic 75 Durometer

NOTES:

Standard breakout boards do not contain current limiting or current protection devices. It is the user's responsibility to limit current. Consult factory with custom requirements, including TVS diode protection or in-line resistors.

Optional cordset supplied standard with plug/plug configuration—pin contacts on one side and socket contacts on the other.



MIL-DTL-24749 TYPE IV

Ground Straps

for Navy shipboard applications

Ground straps utilized in shipboard applications are subject to grueling environmental conditions: wet, cold, salt water spray, and caustic hydraulic fluids. Conventional copper braid/copper lug ground straps corrode, and become a source of electrical resistance problems in these harsh environments.

Glenair MIL-DTL-24749 Rev B Type IV ground straps solve these corrosion and electrical resistance problems with a unique 50% Stainless Steel 316L / 50% Nickel 200 36AWG blend braid, and passivated Stainless Steel lugs. These US Navy-approved ground straps are qualified to the rigorous standards of M24749, and are tested beyond the mil-spec to survive 1000 hours salt spray. Allowed usages for Type IV straps can be found in MIL-STD-1310H.

- Meets the rigorous specifications of MIL-DTL-24749 Rev. B
- Tested to survive 1000 hours salt spray
- Unique Stainless Steel/Nickel hybrid braid
- Available in six standard configurations, with non-standard length/lug size configurations available



Glenair MIL-DTL-24749 Rev. B Type IV Stainless Steel/Nickel Ground Straps: US Navy qualified and tested to survive extreme environments

The Glenair logo features the word "Glenair" in a stylized, blue, serif font. The letter "G" is significantly larger and more prominent than the other letters. A registered trademark symbol (®) is located to the right of the word.

For more information contact Glenair at **818-247-6000** or visit our website at **www.glenair.com**
U.S. CAGE code 06324

MIL-DTL-24749 REV B TYPE IV Stainless Steel/Nickel Ground Straps



How To Order					
Sample Part Number	MS24749	-IV	-B	-L	-H
Product Series	MIL-DTL-24749 Rev. B Type IV bond strap				
Bond Strap Type	IV = Flat CRES 316 / Nickel 200 braid with mounting lugs				
Standard Size Code	A = 6.0" length; 1.0" width, .406 H dia. D = 6.0" length; 1.0" width, .282 H dia. B = 12.0" length, 1.0" width, .406 H dia. E = 12.0" length, 1.0" width, .282 H dia. C = 18.0" length, 1.0" width, .406 H dia. F = 18.0" length, 1.0" width, .282 H dia. N = for non-standard sizes				
Non-Standard Length	Non-Standard length in inches (omit for standard sizes)				
Hole Diameter	Non-Standard diameter in inches (omit for standard sizes)				

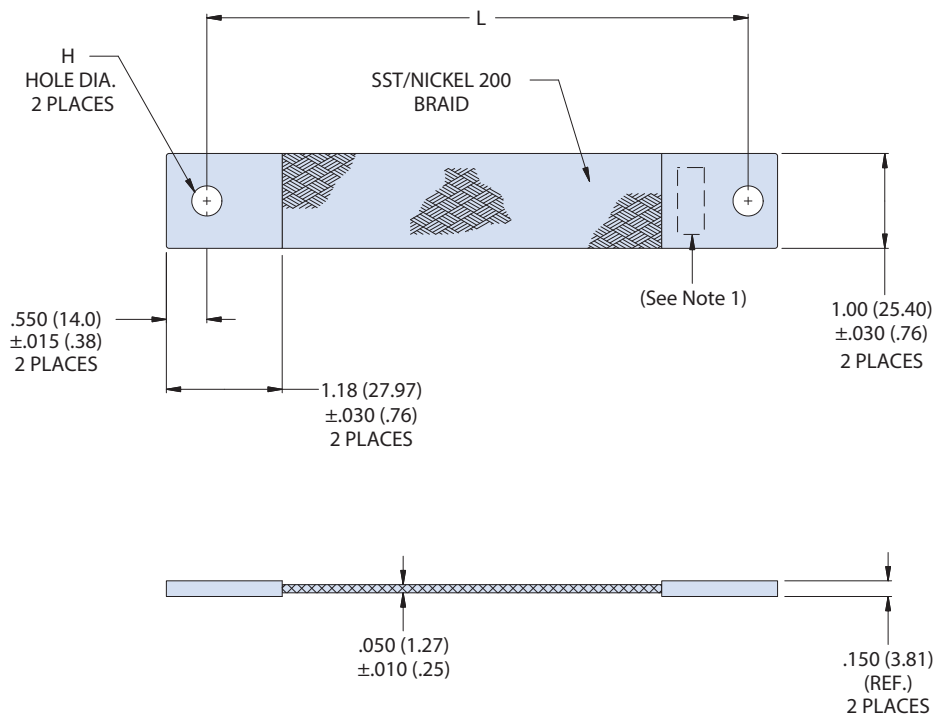

NOTES

1. Lugs are ink stamped or electro-etched per M24749 Rev B. Minimum character height shall be $.06 (1.52)$
2. Metric dimensions (mm) indicated in parentheses
3. Codes A – F are standard lengths. To order non-standard straps, omit Standard Size Code and enter length (in inches) in part number.

MATERIAL/FINISH

Lugs - 316L Stainless Steel/Passivate
 Braid - 316L Stainless Steel 36 AWG, 50%; 200 Nickel 36 AWG, 50%



SERIES 600

Digital Torque Wrench and Adjustable-Tilt Bench Stand

**For reliable high-volume connector-to-backshell assembly
and torque measurement**

The Glenair Dual-Drive Digital Torque Wrench features a dual-sided drive head for hand or bench mount use plus an ergonomic handle with built-in digital readout display. Available torque units include: Ft-lb, Nm, Kg-Cm, or In-lb. Peak and Track modes available. Data collection via supplied USB cable and software provides quality departments the ability to track and record individual torque values for calibration and certification.

Horizontal Bench Stand

Constructed from aluminum, the bench mount tilts to five different ergonomic positions.

FEATURES

- 999 memory storage
- Track and Peak modes
- Auto power off
- LED alarm flash indicator
- Data output
- Overload Warning LED

SUPPLIED WITH

- Batteries
- AC adapter
- USB Cable
- Data retrieval software

TORQUE WRENCH

600-161

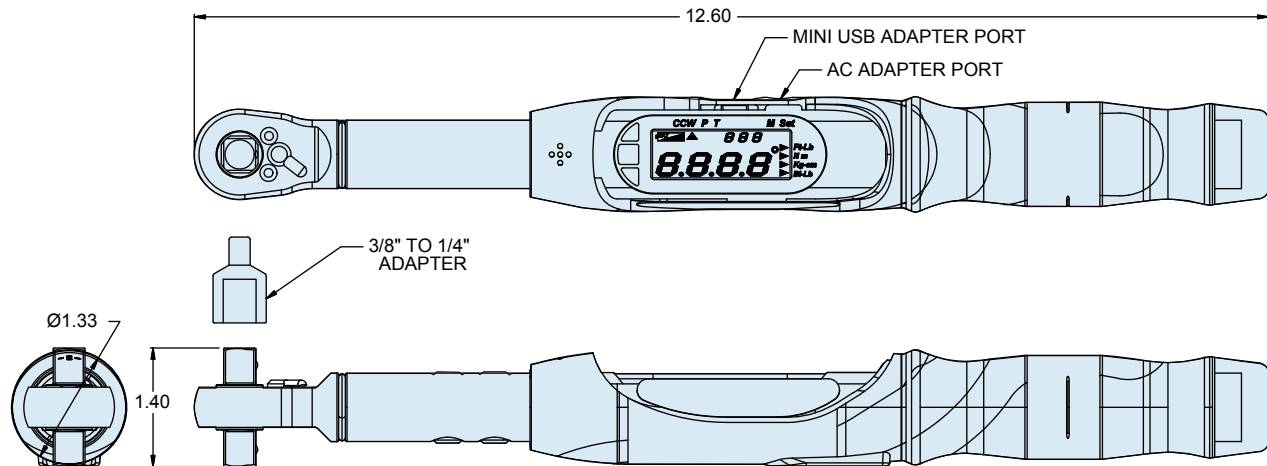

1. Use in conjunction with Glenair connector and backshell tools
2. Torque range: 15-300 in/lbs; digital graduations 1/10 in/lb;
3. Accuracy: cw/ccw $\pm 2\%$ of reading 10% to 100% of full scale
4. Replacement battery: AA x 2
5. USB cable, data tracking software, AC adapter, and 3/8" to 1/4" drive adapter included
6. Weight: 1.45 Lb, w/case 2.28 Lb

BENCH STAND

600-162

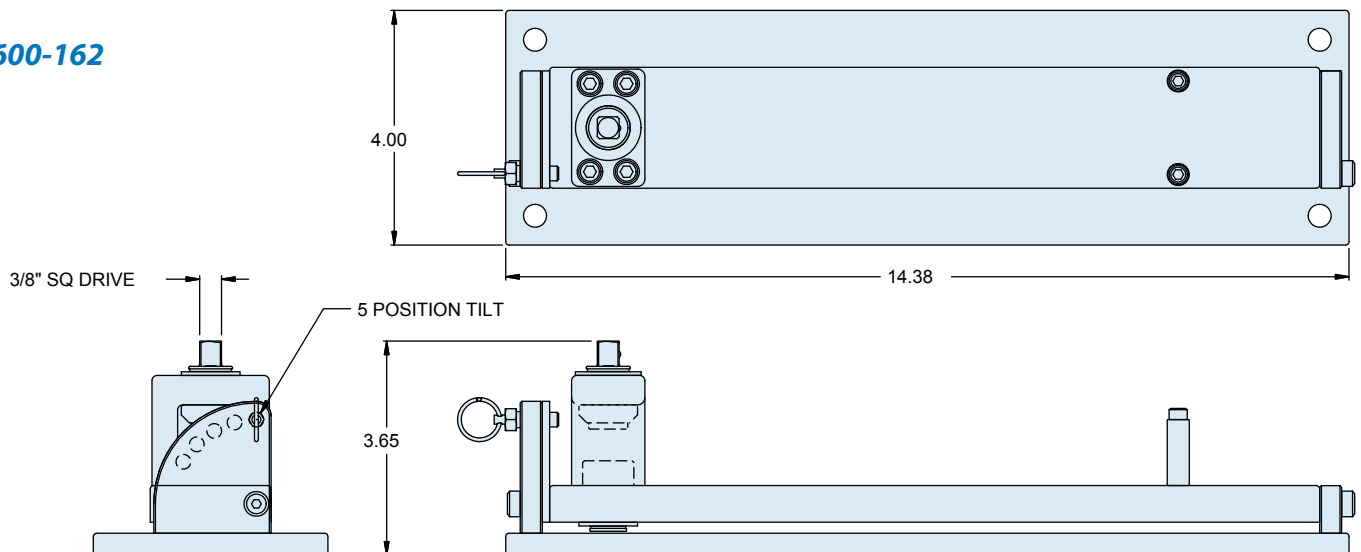

1. Use in conjunction with Glenair 600-161 digital torque wrench
2. Material: aluminum, steel, bronze weight: 4.62 Lb

Gift or Letter Bomb?

"The crew of the space shuttle Challenger honored us by the manner in which they lived their lives. We will never forget them, nor the last time we saw them, this morning, as they prepared for their journey and waved goodbye and 'slipped the surly bonds of Earth' to 'touch the face of God.'"

—Ronald Reagan

This past January marked 28 years since the Challenger Space Shuttle disaster shockwave reverberated around the world. The shuttle program had completed 24 successful missions prior to this one fateful launch. But as far as the public was concerned, all of the successful missions leading up to Challenger had been cancelled out—much like a zero in a long multiplication problem will cancel out all the other multipliers regardless of their value.

In his critical appendix to the Challenger accident report Richard Feynman stated that, "certification criteria used in (Shuttle) Flight Readiness Reviews often develop a gradually decreasing strictness. The argument that the same risk was flown before without failure is often accepted as an argument for the safety of accepting it again. Because of this, obvious weaknesses are accepted again and again, sometimes without a sufficiently serious attempt to remedy them, or to delay a flight because of their continued presence."

On the other hand, he stated that the avionics (software) development system effectively employed, "...an independent verification group, that takes an adversary attitude to the software development group, and tests and verifies the software as if it were a customer of the delivered product."

Glenair has been blessed in our 50 plus years as a high-reliability interconnect supplier that we have never had to face a life-and-death disaster that resulted from the failure of our technology. And we have every intention of going another 50 years with our record intact. One way we can ensure our ongoing success, is to accept Feynman's wisdom that planned oversight and criticism in the development process is a desirable thing and is in fact the key to ensuring reliable technology performance.

The trick for us, I think, is to deliver criticism and oversight in ways that make it "a gift and not a letter-bomb" for the receiver. And of course it helps if the receiver views criticism in the same manner—as something as normal and desirable as having an editor review a written work, or a quality engineer measure and inspect a part. When we give and accept criticism in our work in a manner that indicates we recognize its value and welcome its role, we are on the right path to preventing early mistakes in a development process from turning into disasters down the line. Feynman's model of having a second independent team doing verification testing is currently used in many organizations—particularly in outfits known for outstanding results—please join me in encouraging its use here at Glenair.

Chris Toomey

Publisher

Christopher J. Toomey

Executive Editor

Marcus Kaufman

Managing Editor

Carl Foote

Editor/Art Director

Mike Borgsdorf

Graphic Designer

George Ramirez

Technical Consultant

Jim Donaldson

Issue Contributors

Lisa Amling
Deniz Armani
Garrett Croft
Tim Gaffney
Gordon Hartley
Dick Holden
Joseph Hsiung
Guido Hunziker
Roberto Leprotti
Dan Mitchell
Lutz Mueller
Dave Tonkiss
Chris Van Soest
Fred Van Wyk

Distribution

Terry White

QwikConnect is published quarterly by Glenair, Inc. and printed in the U.S.A. All rights reserved. © Copyright 2014 Glenair, Inc. A complete archive of past issues of QwikConnect is available on the Internet at www.glenair.com/qwikconnect

GLENNAIR, INC.

1211 AIR WAY
GLENDALE, CA 91201-2497
TEL: 818-247-6000
FAX: 818-500-9912
E-MAIL: sales@glenair.com
www.glenair.com

