

SERIES 79 MICRO-CRIMP RECTANGULAR CONNECTORS

Backshells and Accessories



799-117, 799-176

Jackpost, Female Hex, Rear Panel Mount

BACKSHELLS AND ACCESSORIES

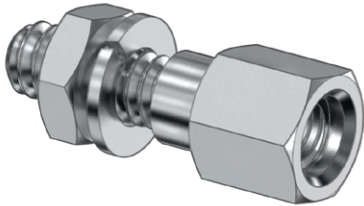

799-117, 799-176

These jackposts fit Series 790, 791 and 792 cable connectors:
790-024, 790-025, 790-045, 790-046, 790-069, 790-070, 791-001, 791-002, 791-003, 791-004, 792-001, 792-002

Rear panel mount jackpost kit accommodates panel thicknesses from 1/32 to 1/8 inch. Four thread sizes: 2-56, 4-40, 6-32 and 8-32. Kit consists of (2) female posts, (2) hex nuts and (2) lockwashers. Passivated 300 series stainless steel.

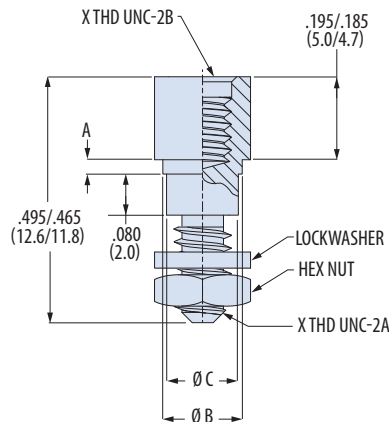
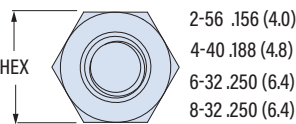
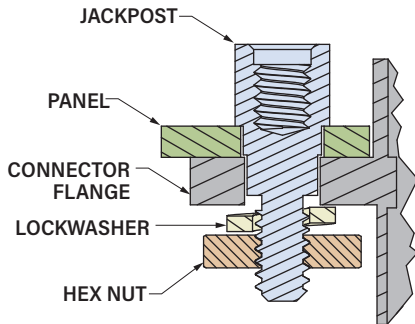

REAR PANEL MOUNT JACKPOST KIT with (2) posts, (2) nuts and (2) lockwashers

X Thread Size	Shell Size	Panel Thickness		Part Number	A ± .003 (0.08)		ø B		ø C	
		in	mm		in	mm	in	mm	in	mm
2-56	Series 790 A-G, J, K	.032	0.8	799-117-A1	.027	.7	.120	3.0	N/A	N/A
		.050	1.3	799-117-A2	.045	1.1	.120	3.0	N/A	N/A
		.062	1.6	799-117-A3	.057	1.4	.120	3.0	N/A	N/A
		.080	2.0	799-117-A4	.075	1.9	.120	3.0	N/A	N/A
		.093	2.4	799-117-A5	.088	2.2	.120	3.0	N/A	N/A
		.125	3.2	799-117-A6	.120	3.0	.120	3.0	N/A	N/A
4-40	Series 790 H, L Series 791 A-G, J, K	.032	0.8	799-117-B1	.027	.7	.155	3.9	.140	3.6
		.050	1.3	799-117-B2	.045	1.1	.155	3.9	.140	3.6
		.062	1.6	799-117-B3	.057	1.4	.155	3.9	.140	3.6
		.080	2.0	799-117-B4	.075	1.9	.155	3.9	.140	3.6
		.093	2.4	799-117-B5	.088	2.2	.155	3.9	.140	3.6
		.125	3.2	799-117-B6	.120	3.0	.155	3.9	.140	3.6
6-32	Series 790 M Series 791 H, L	.032	0.8	799-117-C1	.027	.7	.210	5.3	.163	4.1
		.050	1.3	799-117-C2	.045	1.1	.210	5.3	.163	4.1
		.062	1.6	799-117-C3	.057	1.4	.210	5.3	.163	4.1
		.080	2.0	799-117-C4	.075	1.9	.210	5.3	.163	4.1
		.093	2.4	799-117-C5	.088	2.2	.210	5.3	.163	4.1
		.125	3.2	799-117-C6	.120	3.0	.210	5.3	.163	4.1
8-32	Series 791 M Series 792 A-F	.032	0.8	799-176-R1	.027	.7	.210	5.3	.190	4.8
		.050	1.3	799-176-R2	.045	1.1	.210	5.3	.190	4.8
		.062	1.6	799-176-R3	.057	1.4	.210	5.3	.190	4.8
		.080	2.0	799-176-R4	.075	1.9	.210	5.3	.190	4.8
		.093	2.4	799-176-R5	.088	2.2	.210	5.3	.190	4.8
		.125	3.2	799-176-R6	.120	3.0	.210	5.3	.190	4.8

SERIES 792 PANEL CUTOUT (SEE NEXT PAGE FOR 790 & 791)

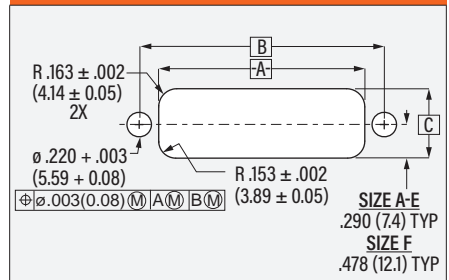

Shell Size	A		B Basic		C	
	± .002 (0.05) in	mm	in	mm	± .002 (0.05) in	mm
A	.725	18.42	1.075	27.31	.623	15.82
B	1.100	27.94	1.450	36.83	.623	15.82
C	1.475	37.47	1.825	46.36	.623	15.82
D	1.850	46.99	2.200	55.88	.623	15.82
E	2.225	56.52	2.575	65.41	.623	15.82
F	2.225	56.52	2.575	65.41	.998	25.35

SERIES 79 MICRO-CRIMP RECTANGULAR CONNECTORS

Backshells and Accessories



799-117, 799-176

Jackpost, Female Hex, Rear Panel Mount

SERIES 790 PANEL CUTOUT

PANEL CUTOUT FOR SERIES 790
SHELL SIZES A-G, J, K

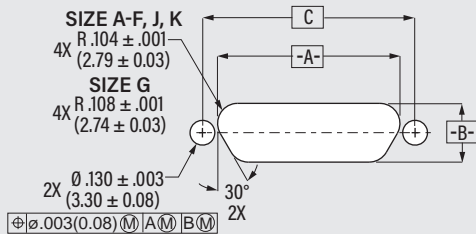

PANEL CUTOUT FOR SERIES 790
SHELL SIZES H AND L

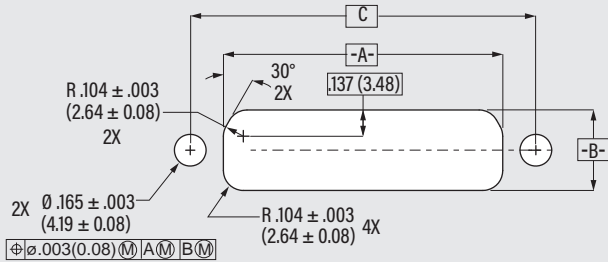

PANEL CUTOUT FOR SERIES 790
SHELL SIZE M

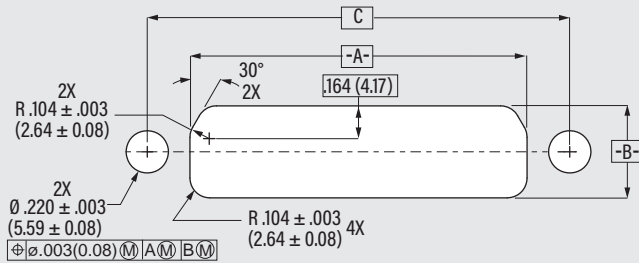

Shell Size	A ± .002 (0.05)		B ± .002 (0.05)		C	
	in	mm	in	mm	in	mm
A	.406	10.31	.306	7.77	.565	14.35
B	.556	14.12	.306	7.77	.715	18.16
C	.706	17.93	.306	7.77	.865	21.97
D	.806	20.47	.306	7.77	.965	24.51
E	.956	24.28	.306	7.77	1.115	28.32
F	1.106	28.09	.306	7.77	1.265	32.13
G	1.084	27.53	.399	10.13	1.215	30.86
H	1.455	36.96	.419	10.64	1.800	45.72
J	1.461	37.11	.306	7.77	1.615	41.02
K	1.864	47.35	.306	7.77	2.015	51.18
L	1.691	42.95	.419	10.64	2.036	51.71
M	1.755	44.58	.479	12.17	2.200	55.88

SERIES 791 PANEL CUTOUT

PANEL CUTOUT FOR SERIES 791
SHELL SIZES A-G, J, K

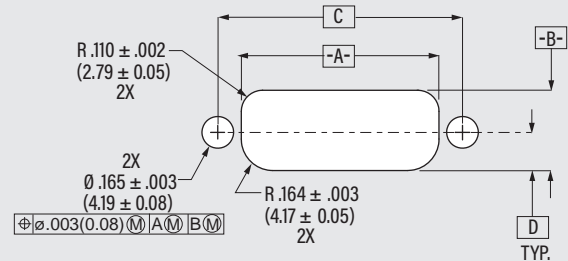

PANEL CUTOUT FOR SERIES 791
SHELL SIZES H AND L

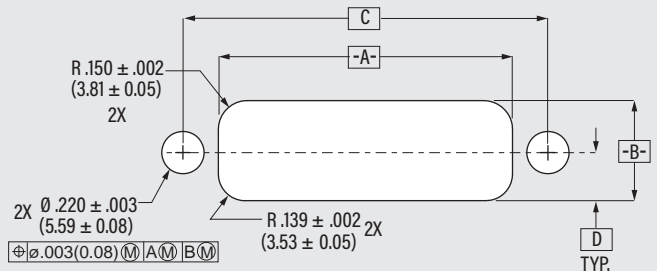

PANEL CUTOUT FOR SERIES 791
SHELL SIZE M

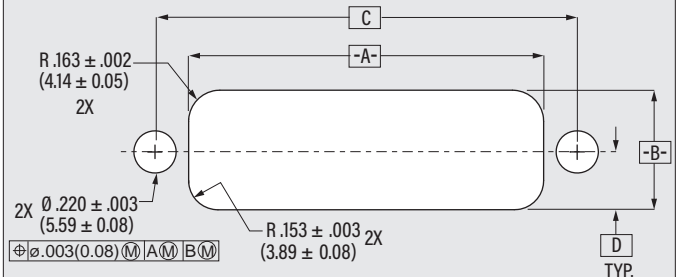

Shell Size	A ± .002 (0.05)		B ± .002 (0.05)		C		D	
	in	mm	in	mm	in	mm	in	mm
A	.505	12.83	.418	10.62	.750	19.50	.199	5.05
B	.655	16.64	.418	10.62	.900	22.86	.199	5.05
C	.805	20.45	.418	10.62	1.050	26.67	.199	5.05
D	.880	22.35	.418	10.62	1.125	28.58	.199	5.05
E	1.030	26.16	.418	10.62	1.275	32.39	.199	5.05
F	1.180	29.97	.418	10.62	1.425	36.20	.199	5.05
G	1.142	29.01	.506	12.85	1.388	35.25	.244	6.20
H	1.531	38.89	.521	13.23	1.900	48.26	.250	6.35
J	1.555	39.50	.418	10.62	1.800	45.72	.199	5.05
K	1.930	49.02	.418	10.62	2.175	55.25	.199	5.05
L	1.767	44.88	.521	13.23	2.136	54.26	.250	6.35
M	1.850	46.99	.623	15.82	2.200	55.88	.290	7.37

BACKSHELLS AND ACCESSORIES