

# Series 66 Protective Covers

for AS50151 Connectors

## 660-045 Plug Cover, Composite

### 5015 Plug Cover



**Corrosion-proof composite.** 660-045 protective cover fits AS50151 threaded plug connectors. High performance thermoplastic, with stainless steel fittings.









### PART NUMBER

<b>660-045</b>	<b>XB</b>	<b>18</b>	<b>H</b>	<b>5</b>	<b>-09</b>
<b>Base P/N</b>	<b>660-045</b>				
<b>Finish</b>	See Table 1				
<b>Shell Size</b>	<b>08 10 12 14 16 18 20 22 24 28 32 36 40 48</b>				
<b>Attachment Type</b>	<b>N</b> No Attachment See Table 2 for Attachment Types				
<b>Attachment Length</b>	Omit for Attachment Type N Length in One Inch Increments				
<b>Attachment Ring</b>	Omit for Attachment Types N and SK <b>-00</b> No Ring See Table 3 for Attachment Ring Codes				

### TABLE 1 FINISH

<b>XB</b>	No Finish, Black Color
<b>XM</b>	Electroless Nickel
<b>XMT</b>	Nickel-PTFE
<b>XO</b>	No Finish, Natural Amber Color
<b>XW</b>	Olive Drab Cadmium
<b>XZR</b>	Zinc-Nickel, Black



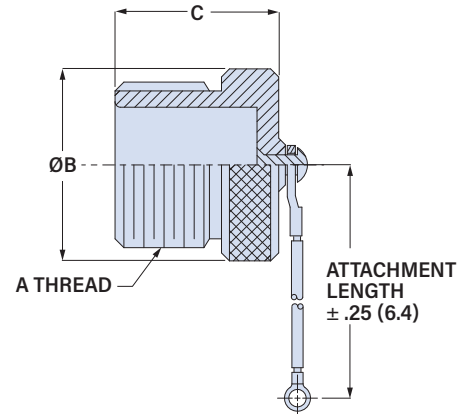

### TABLE 2 ATTACHMENT TYPE

<b>D</b>	 <b>SST Bead Chain</b> .125 (3.2) diameter, size 6, -65 to +200 °C
<b>F</b>	 <b>Wire Rope, Blue Nylon Jacket</b> 6/6 nylon over stainless steel rope, fair flexibility, good abrasion resistance, -55 to +100 °C
<b>G</b>	 <b>Black Nylon Rope</b> Very flexible, good abrasion and fuel resistance, .094 (2.4) diameter, -55 to +100 °C
<b>H</b>	 <b>Wire Rope, Clear FEP Jacket</b> Clear FEP jacket over SST rope, fair flexibility, good abrasion resistance, .100" diameter, -65 to +200 °C
<b>S</b>	 <b>Sash Chain</b> #8 sash chain, stainless steel. Length tolerance is ± one link. .280 (71)
<b>SK</b>	 <b>Nylon Rope with Slip Knot</b> Very flexible, good abrasion and fuel resistance, .094 (2.4) diameter. Length includes .5" (13mm) dia. loop, -55 to +100 °C
<b>T</b>	 <b>SST Wire Rope, No Jacket</b> Good flexibility, good abrasion resistance, .047 (1.2) diameter, passivated, -65 to +200 °C
<b>U</b>	 <b>Wire Rope, Black Polyurethane</b> Stainless steel rope with black polyurethane coating, flexible, excellent abrasion resistance and resistance to fuels, .080" (2mm) diameter, -55 to +125 °C

Shell Size	A Thread Class 2A	ø B Max In.	14.3 mm.	C Max In.	16.7 mm.
08	.500-28 UNEF	.562	14.3	.656	16.7
10	.625-24 UNEF	.687	17.4	.656	16.7
12	.750-20 UNEF	.812	20.6	.844	21.4
14	.875-20 UNEF	.937	23.8	.844	21.4
16	1.00-20 UNEF	1.062	27.0	.844	21.4
18	1.125-18 UNEF	1.187	30.1	.844	21.4
20	1.250-18 UNEF	1.312	33.3	.844	21.4
22	1.375-18 UNEF	1.437	36.5	.844	21.4
24	1.500-16 UNEF	1.562	39.7	.844	21.4
28	1.750-18 UNS	1.812	46.0	.844	21.4
32	2.000-18 UNS	2.062	52.4	.844	21.4
36	2.250-16 UN	2.312	58.7	.844	21.4
40	2.500-16 UN	2.562	65.1	.844	21.4
44	2.750-16 UN	2.812	71.4	.844	21.4
48	3.000-16 UN	3.062	77.8	.844	21.4

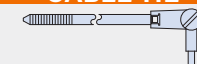

### TABLE 3 ATTACHMENT RING

EYELET		STYLE A RING		STYLE B RING		SPLIT RING	
							
<b>Code</b>	<b>Eyelet I.D. ±.010 (0.3)</b>	<b>Code</b>	<b>Ring I.D. ±.015 (0.4)</b>	<b>Code</b>	<b>Ring I.D. ±.015 (0.4)</b>	<b>Code</b>	<b>Ring I.D. ±.015 (0.4)</b>
-06	.125 (3.2)	-095	.312 (7.9)	-10	.593 (15.1)	-50	.425 (10.8)
-01	.140 (3.6)	-100	.391 (9.9)	-12	.718 (18.2)	-52	.485 (12.3)
-09	.156 (4.0)	-101	.516 (13.1)	-13	.765 (19.4)	-54	.640 (16.3)
-05	.167 (4.2)	-103	.641 (16.3)	-14	.844 (21.4)	-56	.750 (19.1)
-02	.182 (4.6)	-104	.708 (18.0)	-15	.890 (22.6)	-58	.890 (22.6)
-03	.191 (4.9)	-105	.766 (19.5)	-17	1.015 (25.8)	-60	1.015 (25.8)
-04	.197 (5.0)	-106	.896 (22.8)	-19	1.140 (29.0)	-62	1.095 (27.8)
-07	.218 (5.5)	-107	1.016 (25.8)	-20	1.203 (30.6)	-64	1.130 (28.7)
		-108	1.141 (29.0)	-21	1.265 (32.1)	-66	1.250 (31.8)
		-208	1.203 (30.6)	-22	1.343 (34.1)	-68	1.350 (34.3)
		-109	1.266 (32.2)	-24	1.484 (37.7)	-70	1.375 (34.9)
		-110	1.391 (35.3)	-27	1.640 (41.7)	-72	1.485 (37.7)
		-111	1.521 (38.6)	-29	1.765 (44.8)	-74	1.625 (41.3)
		-112	1.641 (41.7)	-30	1.890 (48.0)	-76	1.750 (44.5)
		-113	1.766 (44.9)	-31	1.953 (49.6)	-80	1.980 (50.3)
		-114	1.891 (48.0)	-33	2.077 (52.8)	-84	2.235 (56.8)
		-115	2.078 (52.8)	-36	2.187 (55.5)	-86	2.310 (58.7)
		-116	2.406 (61.1)	-40	2.406 (61.1)	-88	2.475 (62.9)
		-117	2.510 (63.8)	-44	2.656 (67.5)	-90	2.655 (67.4)
<b>CABLE TIE</b>							
							
	<b>-WS</b> Black 6/6 nylon cable tie 1.77 (45.0) max. wire bundle dia.						