

Series 36 Strain Relief Backshells

for MIL-DTL-38999 Series III/IV Connectors

360H*001 Backshell, Strain Relief, Spin Coupling

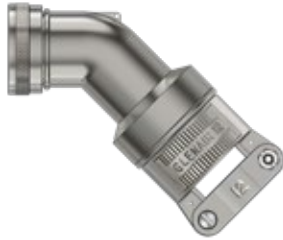

Straight, 45° and 90°. Heavy duty saddle clamp. 360H*001 backshell fits MIL-DTL-38999 Series III and IV connectors. Spin coupling, nonenvironmental. Heavy duty die cast saddle clamp has stainless steel telescoping fillister head screws and lockwashers. Available in aluminum or stainless steel.

Adapter Code H

This accessory fits these connectors:
MIL-DTL-38999 Series III and Series IV

PROFILES

S Straight	A 90°
B 45°	D 90° Split
H 45°	J 90°
M 45°	N 90°

PART NUMBER

360HS001 M 17 08 H 3

Base Part No.	Profile
360HS001	S Straight
360HA001	A 90° Elbow
360HB001	B 45° Elbow
360HD001	D 90° Split
360HH001	H 45° Cut/Weld
360HJ001	J 90° Cut/Weld
360HM001	M 45° Full Radius
360HN001	N 90° Full Radius

Material/Finish	
C	Alum/ Black Anodize
M	Alum/ Electroless Nickel
MT	Alum/ Nickel-PTFE
NF	Alum/ Olive Drab Cadmium
ZR	Alum/ Black Zinc-Nickel
TZ	Alum/ Tin-Zinc
ZI	SST/ Passivated (Profiles H, J, M, N, S only)

Shell Size	Shell Size									
	9	11	13	15	17	19	21	23	25	
	A	B	C	D	E	F	G	H	J	
Size Code	09	11	13	15	17	19	21	23	25	

Entry Size*	Max Cable Dia.	Shell Size*	Entry Size	Max Cable Dia.	Shell Size*
03	.250 (7.9)	09-25	16	.937 (23.8)	21-25
04	.312 (7.9)	11-25	20	1.250 (31.8)	25
06	.437 (11.1)	13-25	24	1.375 (34.9)	-
08	.562 (14.3)	15-25	28	1.625 (41.3)	-
10	.625 (15.9)	15-25	32	1.875 (47.6)	-
12	.750 (19.1)	17-25			

* If selected entry size exceeds shell size range, a Style 2 transition adapter will be included. See Maximum Entry Size for details.

Strain Relief H Saddle Clamp,

Length

3	1.5 inches
4	2.0 inches
6	3.0 inches
8	4.0 inches

Applies to Profile **S** only. If Entry Size is greater than "Maximum Entry Size" (see next page), then 2 inch minimum applies.

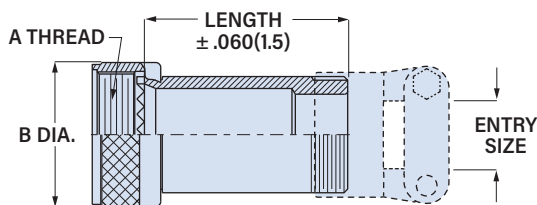
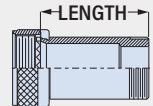

Shell Size	A Thread	øB Max in	øB Max mm	Shell Size	A Thread	øB Max in	øB Max mm
9 (A)	M12X1.0-6H	.770	19.6	19 (F)	M28X1.0-6H	1.360	34.5
11 (B)	M15X1.0-6H	.840	21.3	21 (G)	M31X1.0-6H	1.480	37.6
13 (C)	M18X1.0-6H	.960	24.4	23 (H)	M34X1.0-6H	1.600	40.6
15 (D)	M22X1.0-6H	1.090	27.7	25 (J)	M37X1.0-6H	1.720	43.7
17 (E)	M25X1.0-6H	1.230	31.2				

Series 36 Strain Relief Backshells

for MIL-DTL-38999 Series III/IV Connectors

360H*001 Backshell, Strain Relief, Spin Coupling

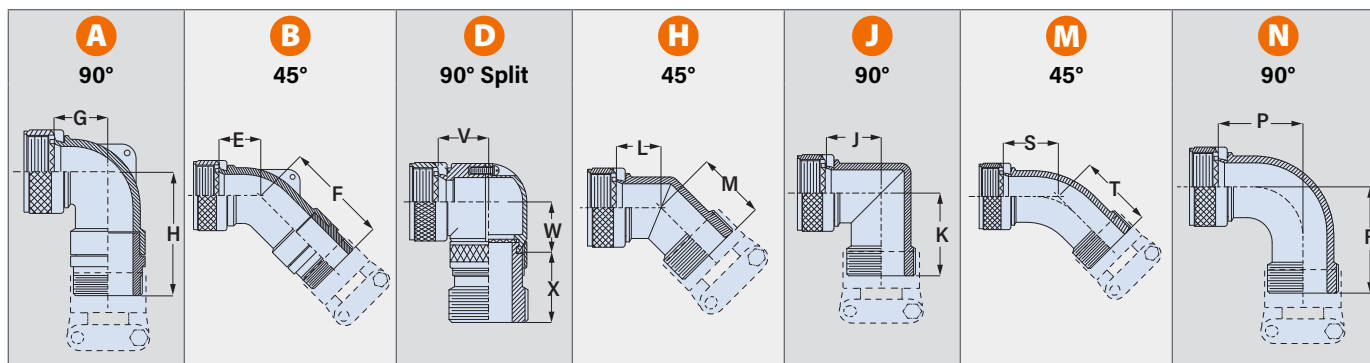

Shell Size	E Max in	F Max in	G Max in	H Max in	J Max in	K Max in	L Max in	M Max in	P Max in	R Max in	S Max in	T Max in	V Max in	W Max in	X Max in															
9 (A)	.457	11.6	1.622	41.2	.500	12.7	1.632	41.5	.834	21.2	1.144	29.1	.726	18.5	1.036	26.3	1.125	28.6	1.445	36.7	.817	20.8	1.127	28.6	.680	17.2	1.670	42.4	1.00	25.4
11 (B)	.520	13.2	1.682	42.7	.595	15.1	1.752	44.5	.898	22.8	1.209	30.7	.753	19.1	1.062	27.0	1.250	31.8	1.570	39.9	.861	21.9	1.181	30.0	.750	19.0	1.725	43.8	1.00	25.4
13 (C)	.582	14.8	1.742	44.2	.610	15.5	1.772	45.0	.956	24.3	1.266	32.1	.777	19.7	1.087	27.6	1.375	34.9	1.695	43.1	.911	23.1	1.231	31.3	.810	20.5	1.795	45.5	1.00	25.4
15 (D)	.645	16.4	2.062	52.4	.700	17.8	2.072	52.6	1.018	25.9	1.328	33.7	.802	20.4	1.113	28.3	1.500	38.1	1.820	46.2	.965	24.5	1.285	32.6	.870	22.0	1.827	46.4	1.00	25.4
17 (E)	.738	18.7	2.172	55.2	.885	22.5	2.162	54.9	1.081	27.4	1.391	35.3	.828	21.0	1.138	28.9	1.625	41.3	1.945	49.4	1.014	25.8	1.334	33.9	.930	23.6	1.927	48.9	1.00	25.4
19 (F)	.926	23.5	2.362	60.0	.975	24.8	2.332	59.2	1.125	28.6	1.435	36.4	.847	21.5	1.157	29.4	1.750	44.5	2.070	52.6	1.064	27.0	1.384	35.2	1.000	25.4	1.985	50.4	1.00	25.4
21 (G)	.926	23.5	2.362	60.0	.975	24.8	2.332	59.2	1.188	30.2	1.498	38.0	.873	22.2	1.183	30.0	1.875	47.6	2.195	55.8	1.118	28.4	1.438	36.5	1.060	26.9	2.046	51.9	1.00	25.4
23 (H)	1.020	25.9	2.512	63.8	1.125	28.6	2.442	62.0	1.250	31.8	1.560	39.6	.898	22.8	1.208	30.7	2.000	50.8	2.320	58.9	1.172	29.8	1.492	37.9	1.120	28.4	2.107	53.5	1.50	38.1
25 (J)	1.020	25.9	2.512	63.8	1.125	28.6	2.442	62.0	1.312	33.3	1.623	41.2	.942	23.5	1.234	31.4	2.125	54.0	2.445	62.1	1.221	31.0	1.541	39.1	1.180	29.2	2.165	54.9	1.50	38.1

STRAIN RELIEF DIMENSIONS

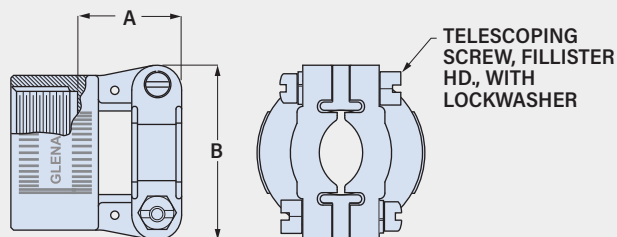

Entry Size	A Max		B Max		Cable Range			
	in	mm	in	mm	Min in	Min mm	Max in	Max mm
03	.780	19.8	.957	24.3	.125	3.2	.250	6.4
04	.780	19.8	.957	24.3	.125	3.2	.312	7.9
06	.780	19.8	1.145	29.1	.250	6.4	.437	11.1
08	.780	19.8	1.332	33.8	.312	7.9	.562	14.3
10	.780	19.8	1.332	33.8	.350	8.9	.625	15.9
12	.811	20.6	1.551	39.4	.500	12.7	.750	19.1
16	.905	23.0	1.770	45.0	.625	15.9	.937	23.8
20	1.092	27.7	2.113	53.7	.875	22.2	1.250	31.8
24	1.124	28.5	2.363	60.0	1.000	25.4	1.375	34.9
28	1.399	35.5	2.770	70.4	1.250	31.8	1.625	41.3
32	1.399	35.5	3.020	76.7	1.437	36.5	1.875	47.6

MAXIMUM ENTRY SIZE

If the selected entry size exceeds the maximum size in this table, the backshell will have a front adapter. This is called a **Style 2** backshell.

Shell Size	Maximum Entry Size
9 (A)	03
11 (B)	04
13 (C)	06
15 (D)	10
17 (E)	12
19 (F)	12
21 (G)	16
23 (H)	16
25 (J)	20

Style 2 Straight Backshell

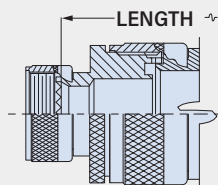

The minimum length code increases from 3 (1 1/2 inches) to 4 (2 inches).

Style 2 45° and 90° Backshells

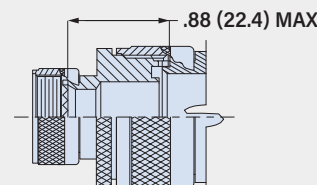

For 45° and 90° backshells, the length increases by .88 inches.