

ASAP CABLE WIRING SCHEMATICS FOR TYPE A, B, C, D AND

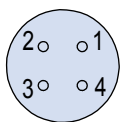

**WIRING DIAGRAM
CABLE TYPE A
100BASE-T UTP**

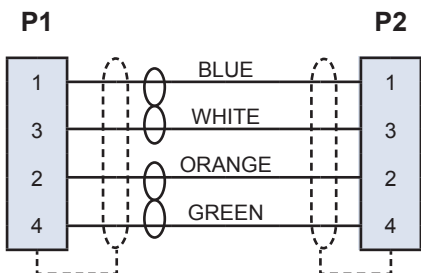

Socket Connector
Mating Face

**WIRING DIAGRAM
CABLE TYPE D
1394 QUAD**

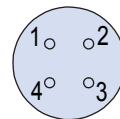
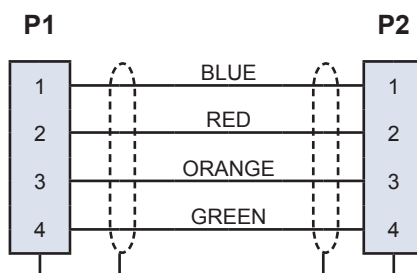

Pin Connector
Mating Face

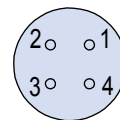

Socket Connector
Mating Face

**WIRING DIAGRAM
CABLE TYPE B
100BASE-T QUAD**

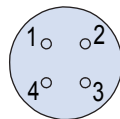
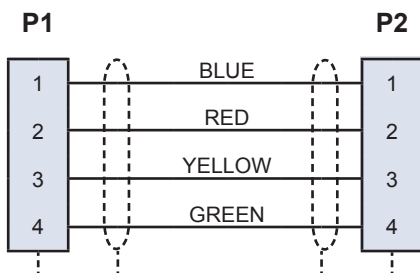

Pin Connector
Mating Face

**WIRING DIAGRAM
CABLE TYPE E
USB 2.0**

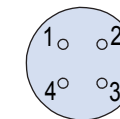
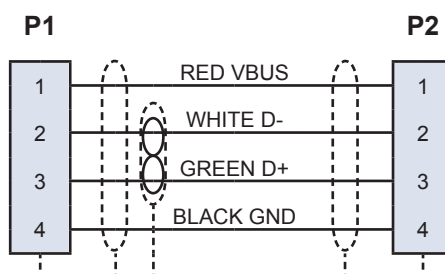

Pin Connector
Mating Face

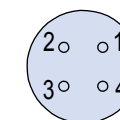

Socket Connector
Mating Face

**WIRING DIAGRAM
CABLE TYPE C
1000BASE-T UTP**

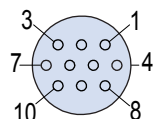
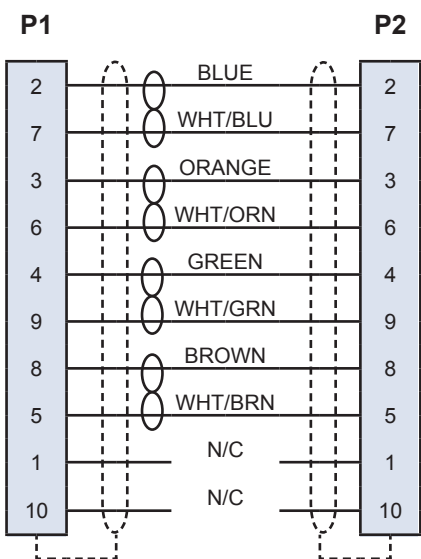

Pin Connector
Mating Face

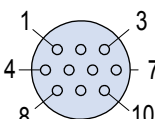

Socket Connector
Mating Face

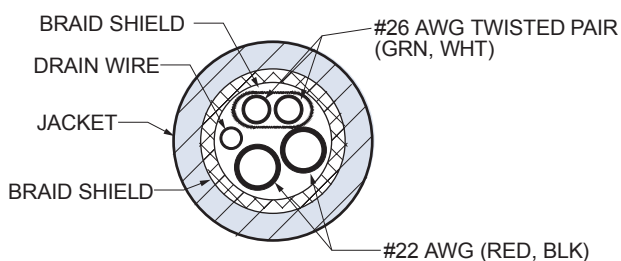

ASAP CABLE WIRING SCHEMATICS FOR TYPE F AND G CABLE



**WIRING DIAGRAM
CABLE TYPE F
TWO 100 OHM SHIELDED TWISTED
PAIRS WITH OVERALL SHIELD**

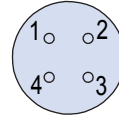
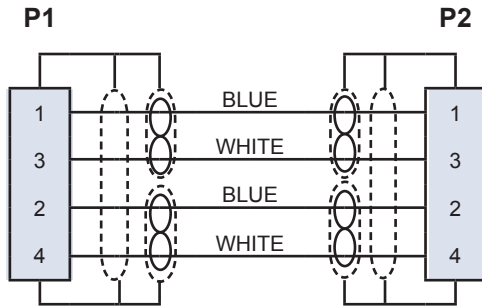

Pin Connector Mating Face

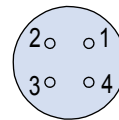

Socket Connector Mating Face

**WIRING DIAGRAM
CABLE TYPE G
FOUR STP**

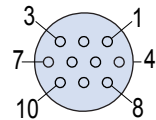
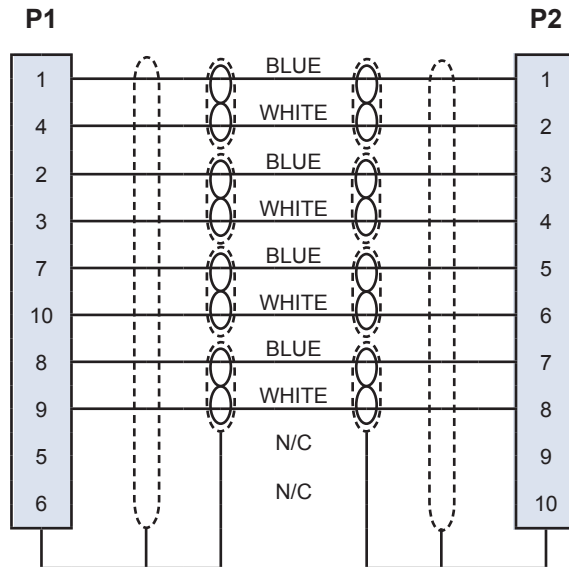

Pin Connector Mating Face

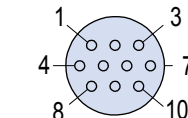

Socket Connector Mating Face