

890-006 and -007
Series 89 Nanominiature Connectors
Single Row Vertical Mount Printed Circuit Board

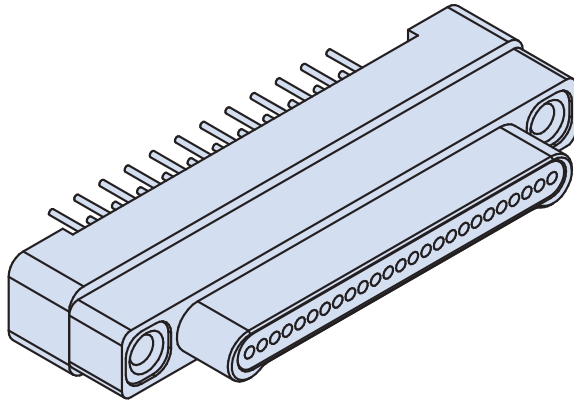

Vertical Mount PCB Nano Connectors feature gold alloy TwistPin contacts. These nanominiature connectors offer premium performance and reliability for demanding applications. Available with #0-80 female threads, or with jackscrews for use with flexible circuits.

Pre-Tinned PC Tails are coated with Sn63Pb37 tin-lead for excellent solderability.

Choose Aluminum, Titanium or Stainless Steel Shells in seven layouts from 9 to 51 contacts. Complies to the requirements of MIL-DTL-32139. These connectors are intermateable with any corresponding Glenair Series 890 single row metal shell nanominiature connector.

HOW TO ORDER VERTICAL MOUNT PCB CONNECTORS

Series	Insert Arrangement/ Contact Type	Shell Material and Finish	Termination Type	PC Tail Length	Hardware
890-006 Plug, Pin Contacts, Single Row, Vertical PCB Nanominiature	Plugs (890-006) 9P 15P 21P 25P 31P 37P 51P	A1 Aluminum Shell, Cadmium Plating	BST "Board Straight Thru- Hole"	1 .110 Inch (2.79 mm)	J Jackscrew, #0-80
		A2 Aluminum Shell, Electroless Nickel Plating		2 .172 Inch (4.37 mm)	T #0-80 Female Thread
890-007 Receptacle, Socket Contacts, Single Row, Vertical PCB Nanominiature	Receptacles (890-007) 9S 15S 21S 25S 31S 37S 51S	T Titanium Shell, Unplated			
		S Stainless Steel Shell, Passivated			
Sample Part Number					
890-007	- 31S	T	- BST	1	T

MATERIALS AND FINISHES

Connector Shell	See Ordering Information
Insulator	Liquid Crystal Polymer (LCP), 30% Glass-Filled
Contacts	Gold Alloy, Unplated
Hardware	300 Series Stainless Steel
PC Tails	#30 (.010 Dia.) Copper Wire, Solder Dipped
PCB Trays	Liquid Crystal Polymer (LCP) or Epoxy
Encapsulant	Epoxy

SPECIFICATIONS

Durability	200 Cycles Minimum
Current Rating	1 AMP Maximum
Voltage Rating (DWV)	300 VAC RMS Sea Level
Insulation Resistance	5000 Megohms Minimum
Operating Temperature	-55° C. to +125° C.
Contact Resistance	71 mV. @1 AMP #30 AWG Wire
Thermal Vacuum Outgassing	1.0% Max TML, 0.1% Max. VCM

SINGLE ROW VERTICAL NANO PCB DIMENSIONS

Plug (Pin) Connectors

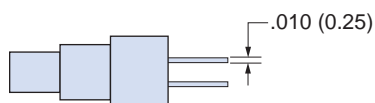
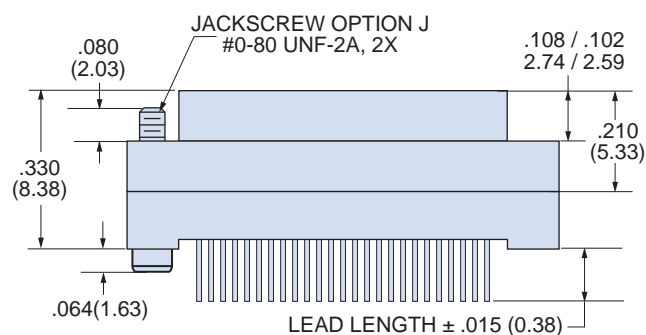
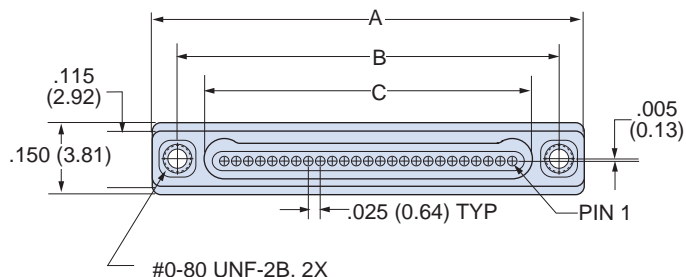

Receptacle (Socket) Connectors

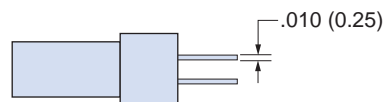
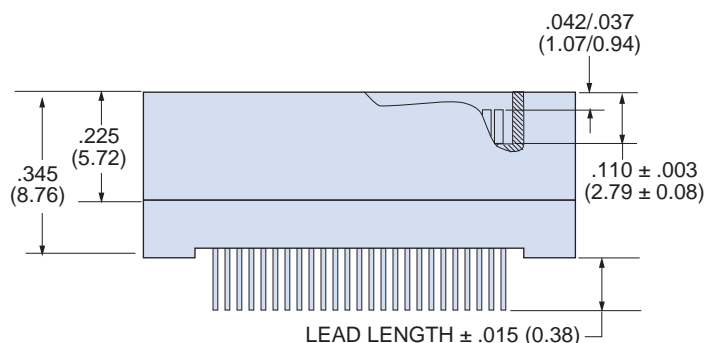
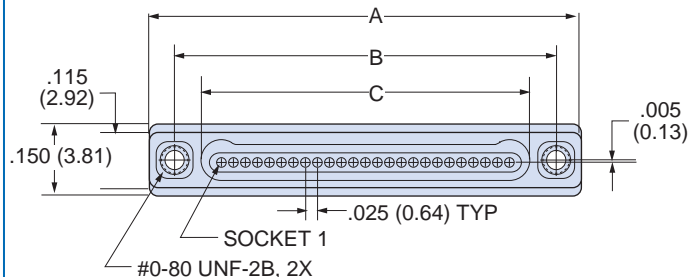

Layout	A		B BSC.		C BSC.	
	In. ± .005	mm. ± 0.13	In.	mm.	In.	mm.
9P	.500	12.70	.395	10.03	.284	7.21
9S	.500	12.70	.395	10.03	.285	7.24
15P	.650	16.51	.545	13.84	.434	11.02
15S	.650	16.51	.545	13.84	.435	11.05
21P	.800	20.32	.695	17.65	.584	14.83
21S	.800	20.32	.695	17.65	.585	14.86
25P	.900	22.86	.795	20.19	.684	17.37
25S	.900	22.86	.795	20.19	.685	17.40
31P	1.050	26.67	.945	24.00	.834	21.18
31S	1.050	26.67	.945	24.00	.835	21.21
37P	1.200	30.48	1.095	27.81	.984	24.99
37S	1.200	30.48	1.095	27.81	.985	24.02
51P	1.550	39.37	1.445	36.70	1.334	33.88
51S	1.550	39.37	1.445	36.70	1.335	33.91

890-006 and -007 Series 89 Nanominiature Connectors Single Row Vertical Mount Printed Circuit Board



Single Row Connectors

Patterns shown are for connector mounting side of PC Board.

VERTICAL PCB PLUG (PIN) CONNECTOR LAYOUT 890-006

9 Contacts

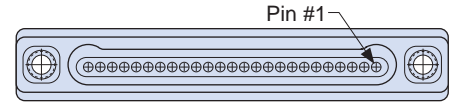
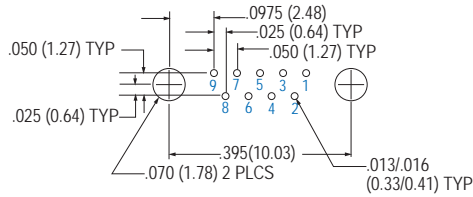

Connector Mating Face

15 Contacts

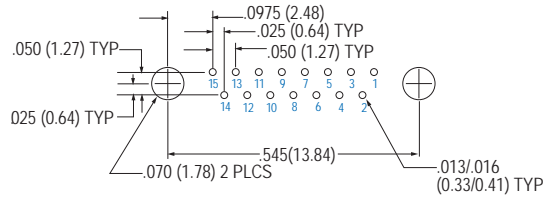

21 Contacts

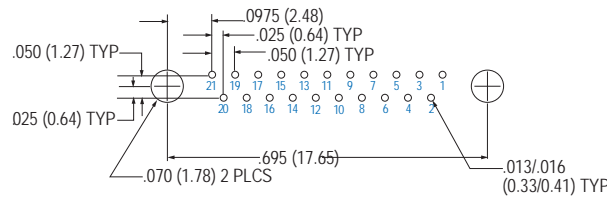

25 Contacts

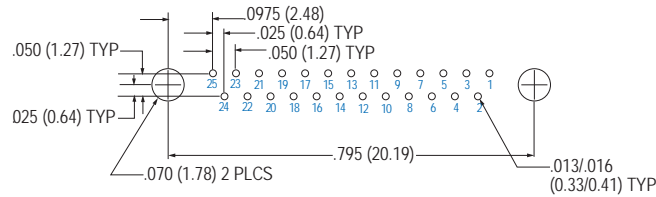

31 Contacts

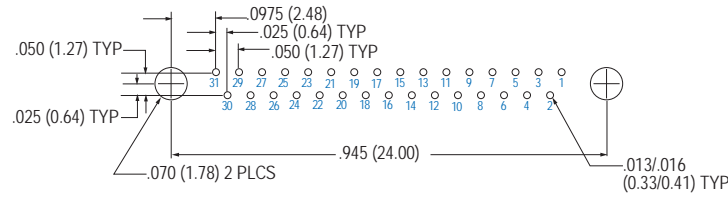

37 Contacts

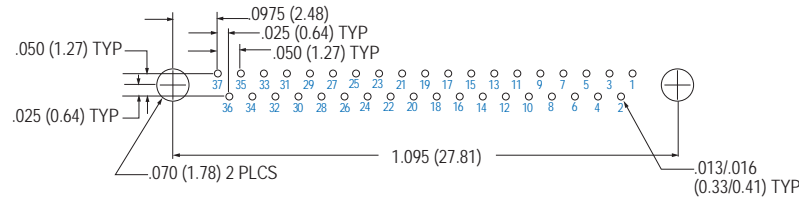

51 Contacts

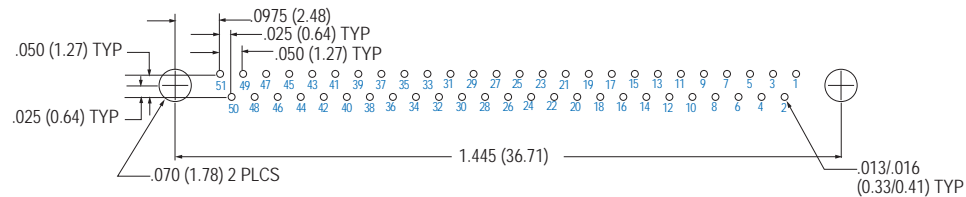

Patterns shown are for connector mounting side of PC Board.

VERTICAL PCB RECEPTACLE (SOCKET) CONNECTOR LAYOUT 890-007

9 Contacts

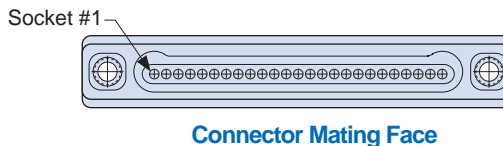
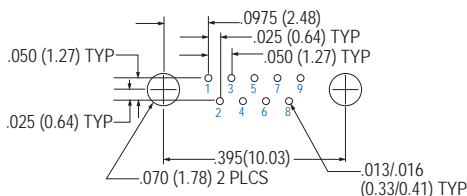

15 Contacts

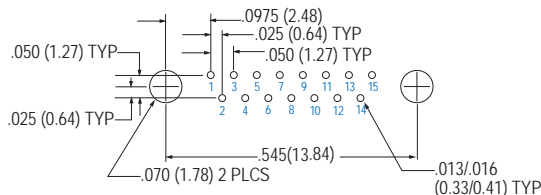

21 Contacts

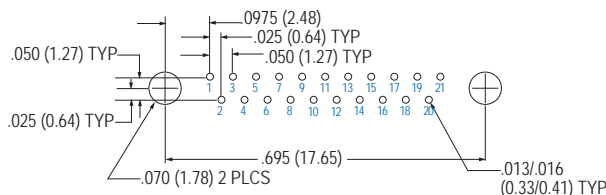

25 Contacts

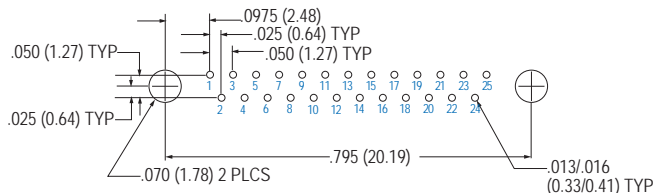

31 Contacts

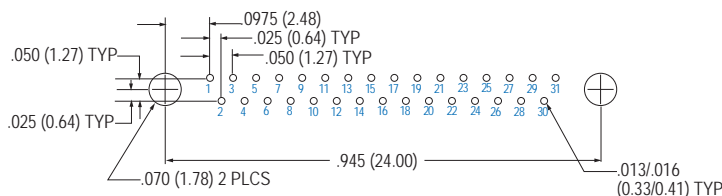

37 Contacts

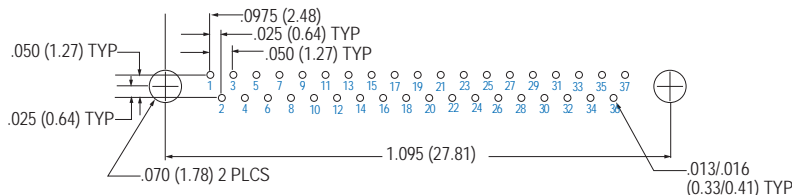

51 Contacts

