

220-03 and 220-13 Bulkhead Connector Receptacle Assemblies Solder Mount

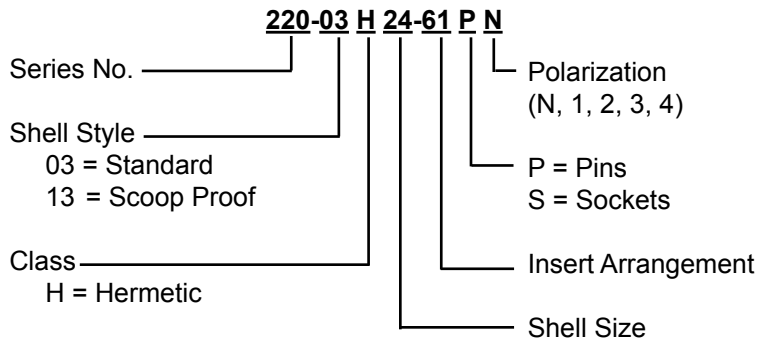
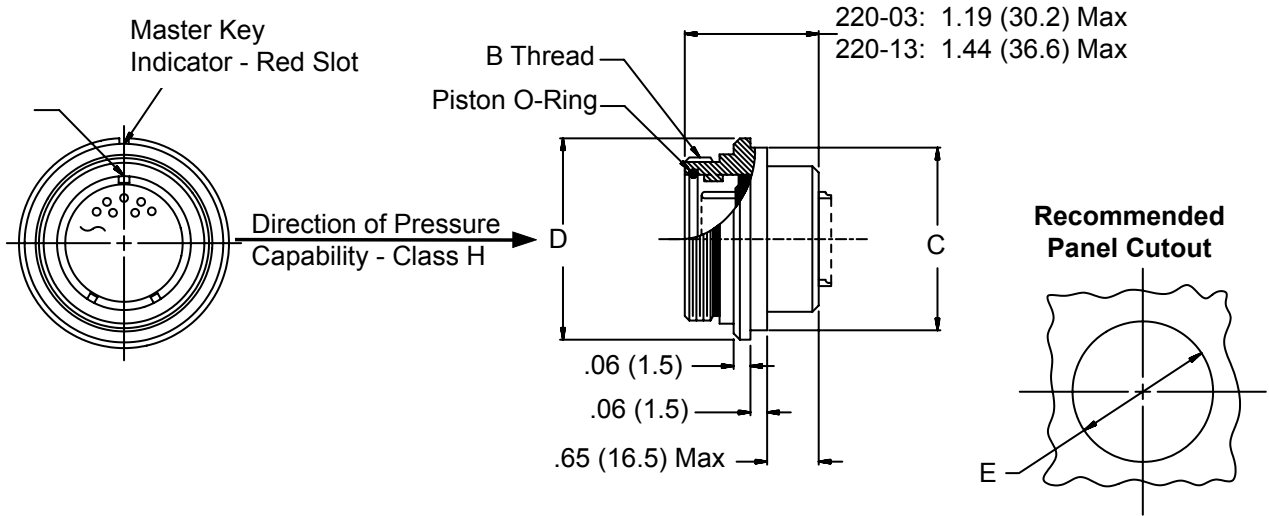

Prior to use, lubricate O-rings with high grade silicone lubricant (Moly-kote M55 or equivalent).

Metric dimensions (mm) are indicated in parentheses.

DIMENSIONS					
SHELL SIZE	B THREAD CLASS 2A	C DIA MAX	D DIA	E DIA	
				+0.10	+(0.3)
10	.750 - .1P - .1L	.870 (22.1)	1.00 (25.4)	.875 (22.2)	
12	.875 - .1P - .1L	.995 (25.3)	1.13 (28.7)	1.000 (25.4)	
14	1.000 - .1P - .1L	1.120 (28.4)	1.25 (31.8)	1.125 (28.6)	
16	1.125 - .1P - .1L	1.245 (31.6)	1.38 (35.1)	1.250 (31.8)	
18	1.250 - .1P - .1L	1.370 (34.8)	1.50 (38.1)	1.375 (34.9)	
20	1.375 - .1P - .1L	1.495 (38.0)	1.63 (41.4)	1.500 (38.1)	
22	1.500 - .1P - .1L	1.620 (41.1)	1.75 (44.5)	1.625 (41.3)	
24	1.625 - .1P - .1L	1.745 (44.3)	1.88 (47.8)	1.750 (44.5)	

REPLACEMENT O-RING PART NUMBERS *	
SHELL SIZE	PISTON O-RING
10	2-014
12	2-016
14	2-018
16	2-020
18	2-022
20	2-024
22	2-026
24	2-028

* Parker O-ring part numbers. Compound N674-70 or equivalent.