

**Hardware Option**

- NN - No Jackpost, No Threaded Insert
- PN - Extended Jackpost for .062" (1.6) PCB, No Threaded Insert
- RN - Extended Jackpost for .196" (5.0) PCB, No Threaded Insert
- NU - Threaded Insert Only, No Jackposts
- PU - Short Jackpost and Threaded Insert

**Rear Panel Jackposts with Threaded Insert:**

- R6U - 0.125" (3.2) Panel
- R5U - 0.094" (2.4) Panel
- R4U - 0.062" (1.6) Panel
- R3U - 0.047" (1.2) Panel
- R2U - 0.031" (0.8) Panel

**Jack screw Options:**

- M - Hex Head Jackscrews
- S - Slot Head Jackscrews

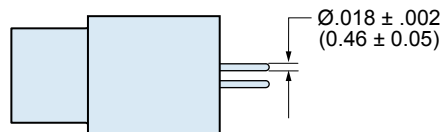

**Printed Circuit Board Micro-D Filter Connectors.** These vertical mount PCB connectors are ideal for flexible circuit or motherboard applications.

**Integral Board Standoffs and Pre-Tinned Tails**—These connectors are solder dipped (63/37 SnPb) and feature a full complement of mounting hardware options.

**240-031**  
**Micro-D Filter Connectors**  
**Vertical Mount Printed Circuit Board**



**TABLE I: SHELL FINISH**

SYM	MATERIAL	FINISH DESCRIPTION
1	Aluminum	Cadmium
2	Aluminum	Nickel
5	Aluminum	Gold
6	Aluminum	Chem Film
33	Aluminum	Ni-PTFE 1000 Hour Grey™

**TABLE II: CAPACITOR ARRAY CODE CAPACITANCE RANGE\***

CLASS	PI - CIRCUIT (pF)	C - CIRCUIT (pF)
A	38,000 - 56,000	19,000 - 28,000
B	32,000 - 45,000	16,000 - 22,500
C	18,000 - 33,000	9,000 - 16,500
D	8,000 - 12,000	4,000 - 6,000
E	3,300 - 5,000	1,650 - 2,500
F	800 - 1,300	400 - 650
G	400 - 600	200 - 300

**MICRO-D FILTER PIGTAIL DIMENSIONS**

Layout	A Max.		B		C Max.		D Max.		E Max.		F	
	In.	mm.	In. ± .003	mm. ± 0.08	In.	mm.	In.	mm.	In.	mm.	In. ± .004	mm. ± 0.10
<b>9P</b>	.785	19.94	.565	14.35	.333	8.46	.184	4.67	.310	7.87	.183	4.65
<b>9S</b>	.785	19.94	.565	14.35	.400	10.16	.250	6.35	.310	7.87	.195	4.95
<b>15P</b>	.935	23.75	.715	18.16	.483	12.27	.184	4.67	.310	7.87	.183	4.65
<b>15S</b>	.935	23.75	.715	18.16	.551	14.00	.250	6.35	.310	7.87	.195	4.95
<b>21P</b>	1.085	27.56	.865	21.97	.633	16.08	.184	4.67	.310	7.87	.183	4.65
<b>21S</b>	1.085	27.56	.865	21.97	.701	17.81	.250	6.35	.310	7.87	.195	4.95
<b>25P</b>	1.185	30.01	.965	24.51	.733	18.62	.184	4.67	.310	7.87	.183	4.65
<b>25S</b>	1.185	30.01	.965	24.51	.801	20.35	.250	6.35	.310	7.87	.195	4.95
<b>31P</b>	1.335	33.91	1.115	28.32	.883	22.43	.184	4.67	.310	7.87	.183	4.65
<b>31S</b>	1.335	33.91	1.115	28.32	.951	24.16	.250	6.35	.310	7.87	.195	4.95
<b>37P</b>	1.485	37.72	1.265	32.13	1.033	26.24	.184	4.67	.310	7.87	.183	4.65
<b>37S</b>	1.485	37.72	1.265	32.13	1.101	27.96	.250	6.35	.310	7.87	.195	4.95

Connector Supplied Without Hardware

Connector Supplied With Threaded Inserts

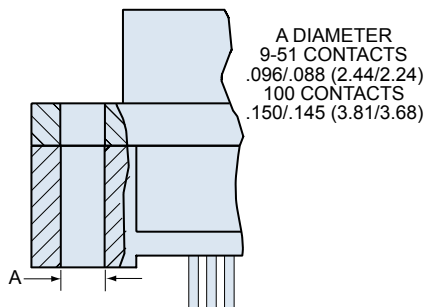

A DIAMETER  
9-51 CONTACTS  
.096/ .088 (2.44/2.24)  
100 CONTACTS  
.150/ .145 (3.81/3.68)

**NN Style**  
Thru-Hole, No Hardware

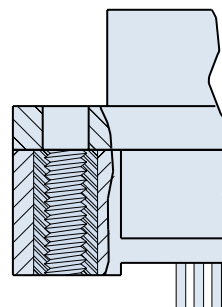

9-51 CONTACTS  
NO. 2-56 UNC-2B  
100 CONTACTS  
NO. 4-40 UNC-2B

**NU Style**  
Threaded Insert

Jackpost and Threaded Insert

Rear Panel Jackpost and Threaded Insert

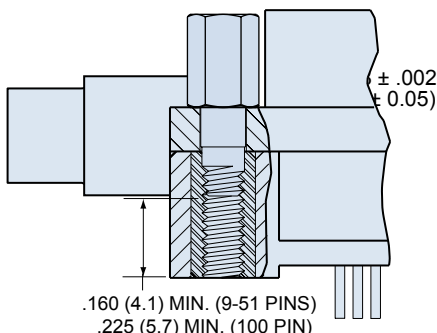

**PU Style**  
Jackpost with Threaded Insert

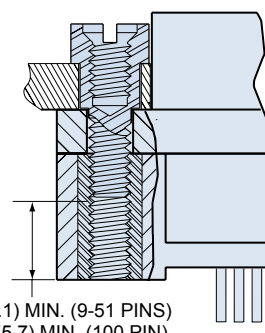

**RU Style**  
Rear Panel Jackpost with Threaded Insert

Extended Jackpost

Jackscrew, Hex

Jackscrew, Slot

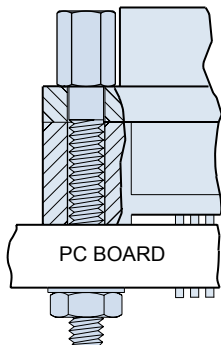

**PN Style for .062" PCB**  
**RN Style for .196" PCB**

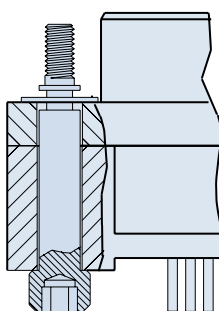

**M Style**  
Hex Head Jackscrew with E-Ring

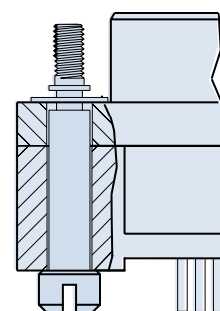

**S Style**  
Slot Head Jackscrew with E-Ring

**240-031**  
**Micro-D Filter Connectors**  
**Vertical Mount PCB Pin Connector Layouts**



**PC Tail Diameter .018 ± .002 (0.46 ± 0.05)**  
**Contact numbers shown are for pin connectors. Reverse for socket.**

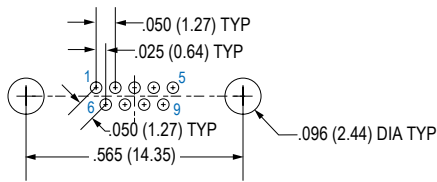

**9 Contacts**

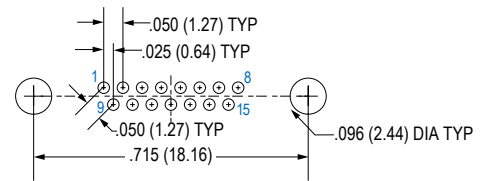

**15 Contacts**

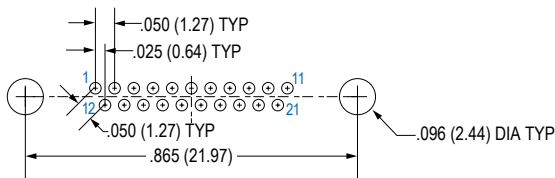

**21 Contacts**

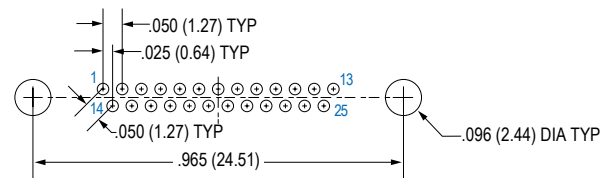

**25 Contacts**

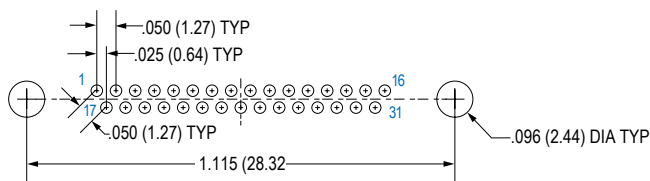

**31 Contacts**

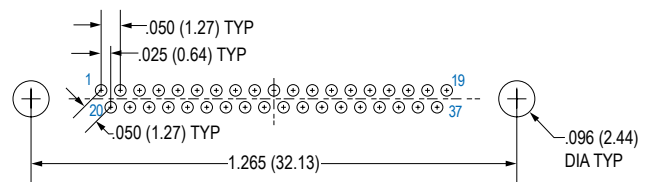

**37 Contacts**

