



BATTLE-TESTED

STAR-PAN™

Power / battery cables and adapters

STAR-PAN POWER CABLES AND BATTERY ADAPTERS

Part No.	NATO Stock No. NSN	Description	Page No.
808-242		BB2590 Battery Adapter with Charging and SMBus	82
TS2-026 (-1, -2, -3)		BB2590 Adapters (Standard, EMI box, and 5V Out options)	83
TS1-027		Battery Connector for Bren-Tronics BTA-70838-8	84
TS1-033		Battery Connector for Bren-Tronics BTA-70909-8	
808-066	5935-01-683-1932	Radio Battery Adapter for Harris and BT70716XX Handheld Radios	85
TS3-022		Universal Radio Power Booster (RPB)	86
808-175		PRC-152A, -152, -148 Universal Battery Adapter / Charger	87
TS8-459		AN/PRC Radio Power Booster	88
TS8-473		AN/PRC-163 Dual Power Cable Battery Eliminator	89
808-063		PRC-152A, -152, -148 Radio Power Booster	90
TS1-067		Cable for use with Radio Battery Adapter	91
TS1-030		Cable for use with Radio Battery Adapter	92
TS1-073		Cable for use with Radio Battery Adapter	93
TS1-045		AN/PRC-163 Dual Charge/Battery Eliminator Cable	94
TS2-003		Power Scavenger	95
TS2-009		Power Conditioner	96
TS1-093		STAR-PAN X Adapter Cable for TS2-009 Power Conditioner	97
TS1-053		Automotive Aux Power / Cigarette Lighter Adapter Cable	98
TS1-054		Mighty Mouse to Battery Clamp Adapter Cable	99
TS1-055		Mighty Mouse to NATO Plug Adapter Cable	100
808-059	6150-01-674-0055	Cigarette Lighter Power Adapter Cable	101
808-064	5995-01-668-8659	AC/DC Power Adapter Cable	102
808-064-EU	5995-01-682-9273		
TS3-060		USB-C Power Delivery Downstream Charging Cable	103

BATTLE-TESTED

STAR-PAN™

Power cables and battery adapters

808-242 BB2590 Battery Adapter with Charging and SMBus



POWER CABLES AND BATTERY ADAPTERS



SPECIFICATIONS

- For connection of referenced battery to STAR-PAN power / data hubs
- Aluminum housing, Olive Drab epoxy paint finish
- Strap color options: standard Coyote Tan, Ranger Green, or Black
- Mighty Mouse 807 (NATO standard) Power In / Battery connectors and BB2590 battery connector
- Weight: 286g
- Export classification: EAR 99

HOW TO ORDER

Sample Part Number:	808-242	-GRN
Adapter Series	BB2590 Battery Connector	
Strap Color Option	-BLK = Black -GRN = Ranger Green Omit = Coyote Tan	

BB2590 Parallel Charging Battery Adapter with SMBus



QUALIFIED FOR USE WITH ALL STAR-PAN POWER / DATA HUBS

LIGHT, II, IV, AND VI

HUB PORT DESIGNATOR:

BATT

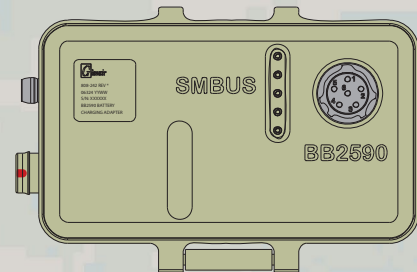
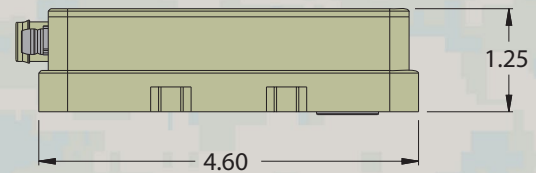
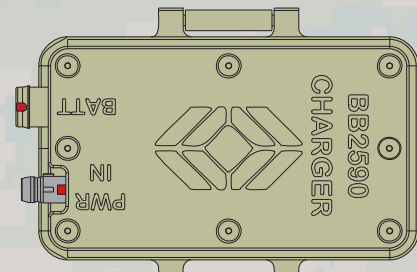
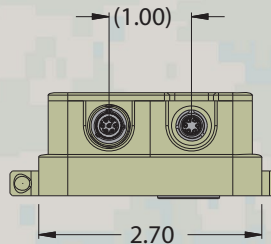

BATTLE-TESTED

STAR-PAN™

Power cables and battery adapters

TS2-026 BB2590 Battery Adapter, EMI Box / 5V Regulator options

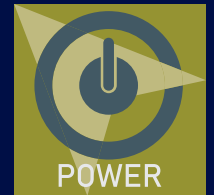

POWER CABLES AND BATTERY ADAPTERS

SPECIFICATIONS

- For connection of BB2590 battery to STAR-PAN power / data hubs
- EMI-protective box option and 5V regulator options
- Aluminum housing, black zinc-nickel finish
- Mighty Mouse 807 (NATO standard) Power In / Battery connector and BB2590 battery connector
- Weight: consult factory
- Export classification: EAR 99

HOW TO ORDER

Sample Part Number:	TS2-026	-1
Adapter Series	BB2590 battery adapter	
EMI Box / 5V OUT Options	Omit = standard configuration -1 = BB2590 Adapter - STAR-PAN Standard with EMI box -2 = BB2590 Adapter - STAR-PAN Standard with EMI box and 5V out -3 = BB2590 Adapter - STAR-PAN Standard 5V Out	



QUALIFIED FOR USE WITH ALL STAR-PAN POWER / DATA HUBS

LIGHT, II, IV, AND VI

HUB PORT DESIGNATOR:

BATT

DEFAULT OPTION
ISOMETRIC
VIEW SHOWN

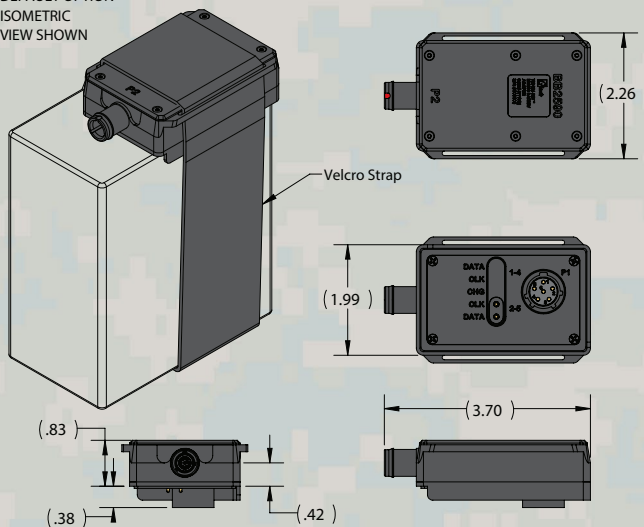

DEFAULT OPTION

EMI BOX OPTION (-1)

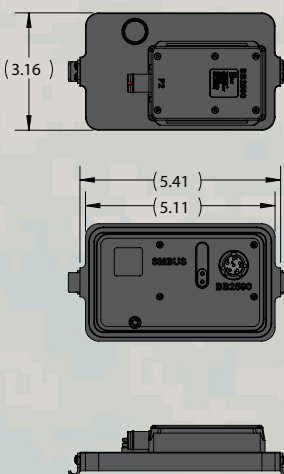

EMI BOX OPTION
ISOMETRIC
VIEW SHOWN

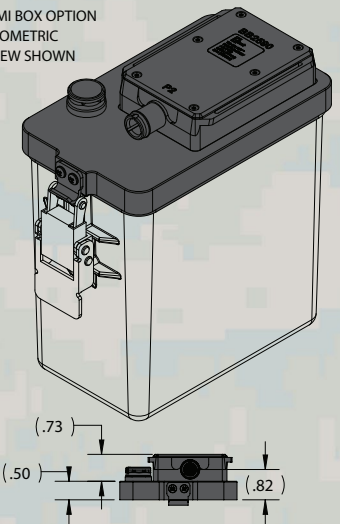

BATTLE-TESTED

STAR-PAN™

Power cables and battery adapters

TS1-027 / TS1-033 for Bren-Tronics Batteries



POWER CABLES AND BATTERY ADAPTERS



Battery Connector for Bren-Tronics Batteries:
TS1-027: BTA-70838-8
TS1-033: BTA-70909-8

SPECIFICATIONS

- Aluminum housing, black conductive finish
- Santoprene jacketed cable, black
- Weight: (consult factory)
- Export classification: EAR99

HOW TO ORDER

Sample Part Number:		TS1-027
Adapter Series	Bren-Tronics Battery Connectors	
	TS1-027: for Bren-Tronics BTA-70838-8 TS1-033: for Bren-Tronics BTA-70909-8	
Length Option	In Inches	
	Omit for standard length: TS1-027 = 21 inches; TS1-033 = 24 inches	



QUALIFIED FOR USE WITH ALL STAR-PAN POWER / DATA HUBS
LIGHT, II, IV, AND VI

HUB PORT DESIGNATOR:
BATT

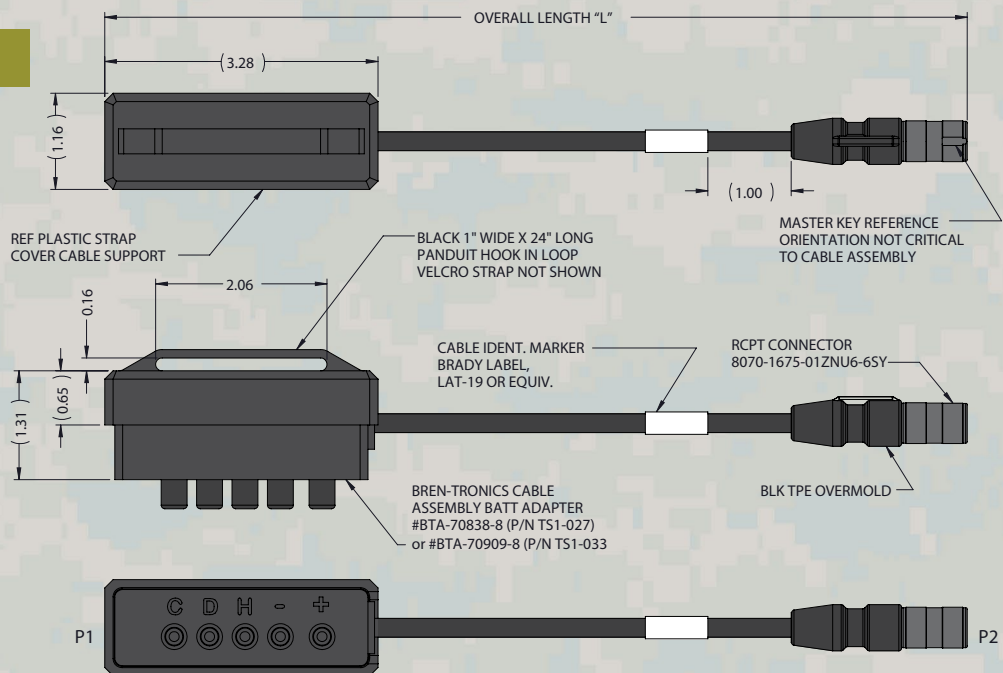

BATTLE-TESTED

STAR-PAN™

Power cables and battery adapters

808-066 Radio Battery Adapter

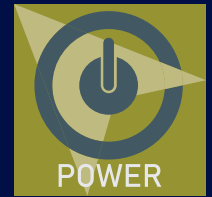

POWER CABLES AND BATTERY ADAPTERS



SPECIFICATIONS

- For connection of for Harris and BT70716XX handheld radio batteries to STAR-PAN power / data hubs
- Aluminum housing, black zinc-nickel finish
- Mighty Mouse 807 (NATO standard) connector
- Weight: 70g
- Export classification: ECCN 3A611.x

HOW TO ORDER

Sample Part Number:

808-066

Adapter Series

Battery Adapter for Handheld Radios

Battery Shoe connects Harris handheld radio and Bren-Tronics BT70716XX batteries



QUALIFIED FOR USE WITH ALL STAR-PAN POWER / DATA HUBS LIGHT, II, IV, AND VI

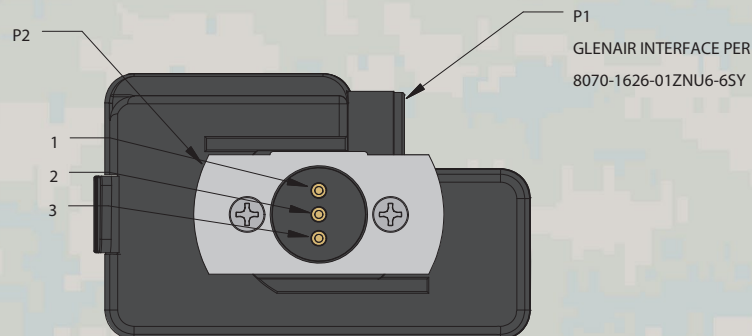
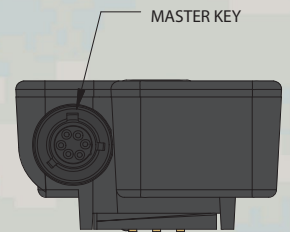
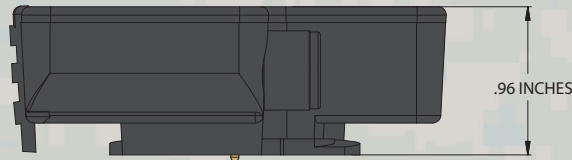
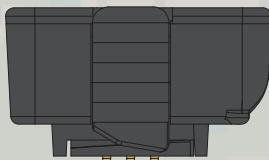
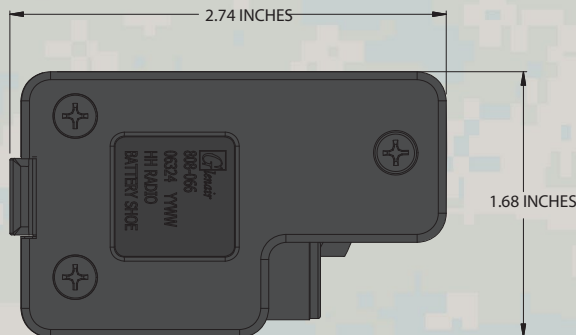

BATTLE-TESTED

STAR-PAN™

Power cables and battery adapters

TS3-022 Universal Radio Power Booster



POWER CABLES AND BATTERY ADAPTERS



SPECIFICATIONS

- Radio Power Booster enables trickle charging of radio batteries and radio holdup to hub
- Aluminum housing, black anodize finish
- Weight: (consult factory)
- Export classification: ECCN 3A611.a

HOW TO ORDER

Sample Part Number:	TS3-022
Adapter Series	BT-70838BE Battery Connector

For Harris AN/PRC-148, -152A, -161, -163; MPU-5; TNR



QUALIFIED FOR USE WITH ALL STAR-PAN POWER / DATA HUBS
LIGHT, II, IV, AND VI

RADIO POWER BOOST

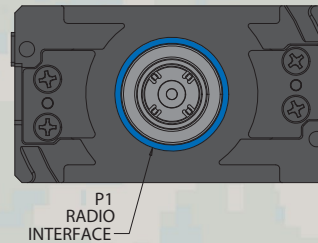

P1
RADIO
INTERFACE

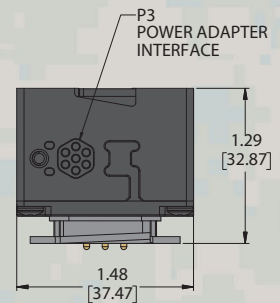
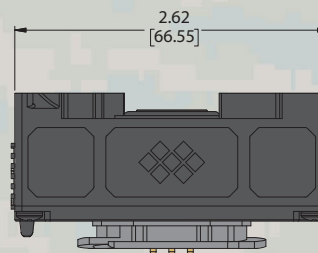
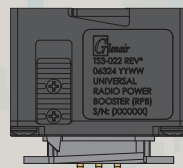

SUPPLIED ACCESSORY

Part No. 808

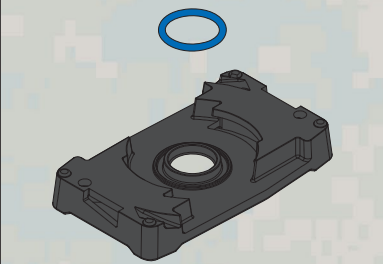

Dust Cover with O-Ring Seal
Rugged black polycarbonate with fluorosilicone O-ring supplied with each assembly

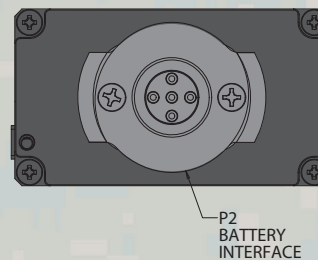

P2
BATTERY
INTERFACE

BATTLE-TESTED

STAR-PAN™

Power cables and battery adapters

808-175 PRC-152A, -152, -148 Battery Adapter / Charger

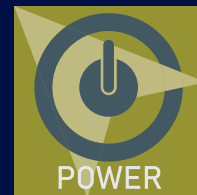

POWER CABLES AND BATTERY ADAPTERS



For Harris PRC-152A, PRC-152, and PRC-148 Radios



QUALIFIED FOR USE WITH ALL STAR-PAN POWER / DATA HUBS LIGHT, II, IV, AND VI

SPECIFICATIONS

- Back-to-back battery adapter and charger
- Aluminum housing, black zinc-nickel finish
- Overmolded, ergonomic connector strain reliefs, black.
- Santoprene jacketed cable, black
- Mighty Mouse 807 (NATO standard) connector
- Weight: (consult factory)
- Export classification: ECCN 3A611.x

HOW TO ORDER

Part Number:	808-175
Adapter Series	Back-to-Back Radio Battery Adapter / Charger

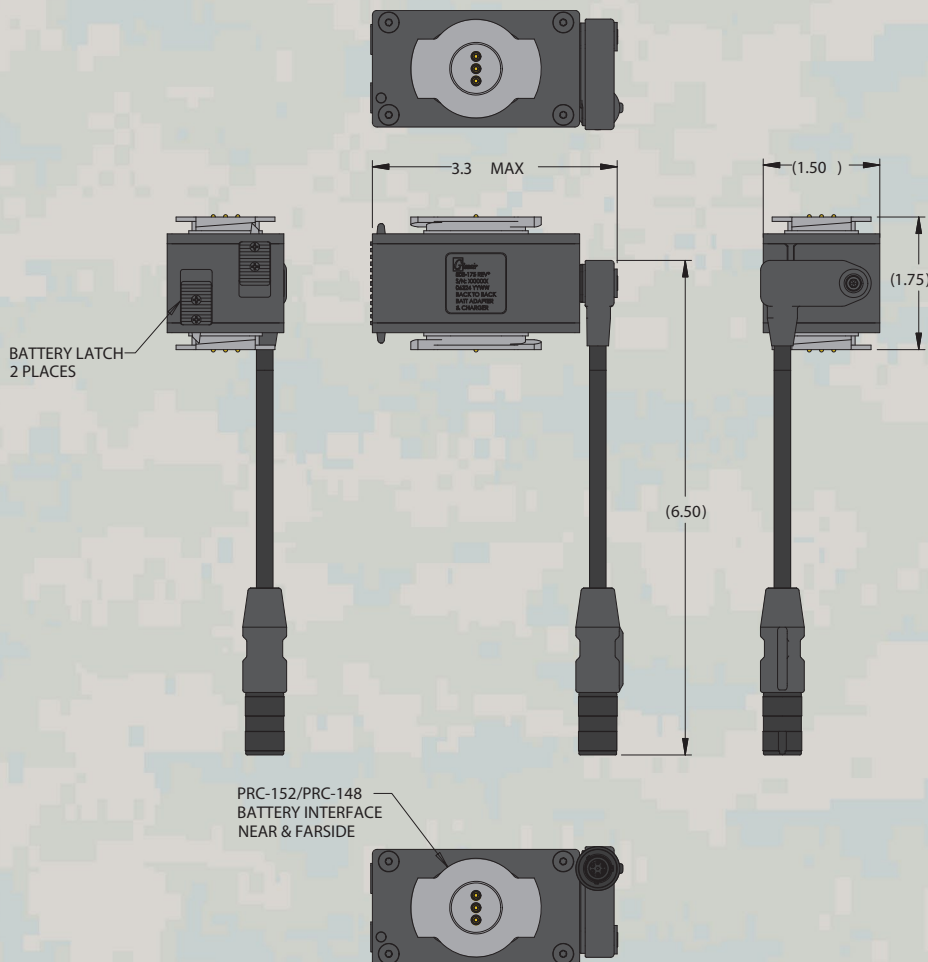

SUPPLIED ACCESSORY

Part No. 808-144

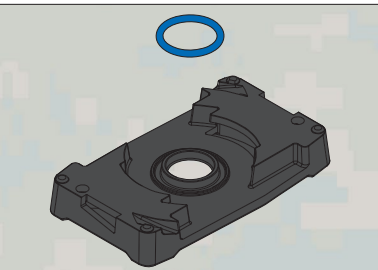

Dust Cover with O-Ring Seal
Rugged black polycarbonate with fluorosilicone O-ring. Two supplied with each assembly

BATTLE-TESTED

STAR-PAN™

Power cables and battery adapters

TS8-459 AN/PRC-163 Radio Battery Adapter



POWER CABLES AND BATTERY ADAPTERS



Battery Adapter for Harris AN/PRC-163



QUALIFIED FOR USE WITH ALL STAR-PAN POWER / DATA HUBS LIGHT, II, IV, AND VI

RADIO POWER BOOST

SPECIFICATIONS

- Radio Power Booster enables trickle charging of radio batteries and radio holdup to hub
- Aluminum housing, black anodized finish
- Weight: (consult factory)
- Export classification: ECCN 3A611.x

HOW TO ORDER

Part Number:	TS8-459
Adapter Series	Radio Battery Adapter

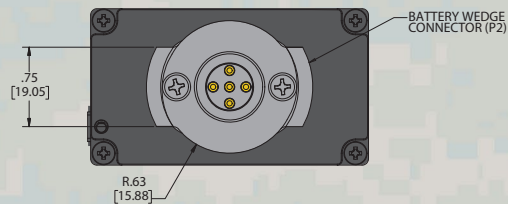
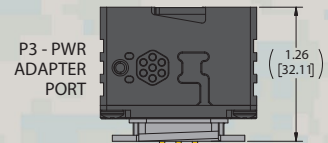
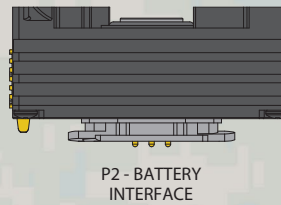
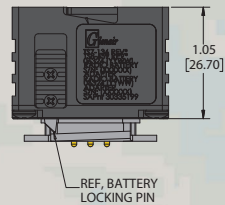
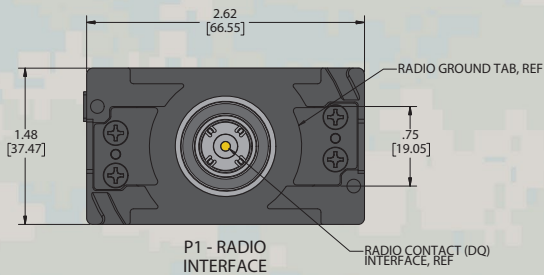

SUPPLIED ACCESSORY

Part No. 808-144

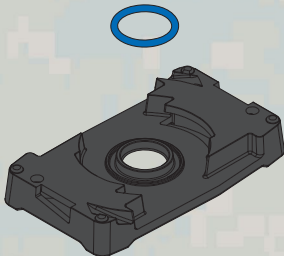

Dust Cover with O-Ring Seal
Rugged black polycarbonate with fluorosilicone O-ring supplied with each assembly

BATTLE-TESTED

STAR-PAN™

Power cables and battery adapters

TS8-473 AN/PRC-163 Dual Power Cable Battery Eliminator

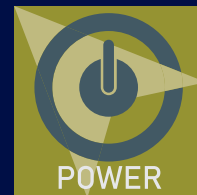

POWER CABLES AND BATTERY ADAPTERS



Battery Eliminator for Harris AN/PRC-163



QUALIFIED FOR USE WITH ALL STAR-PAN POWER / DATA HUBS LIGHT, II, IV, AND VI

HUB PORT DESIGNATOR: BATT

SPECIFICATIONS

- Battery eliminator adapter
- Aluminum housing, black anodized finish
- Overmolded, ergonomic connector strain reliefs, black.
- Santoprene jacketed cable, black
- 2 Mighty Mouse 807 (NATO standard) connectors for “hot swap” capability
- Weight: (consult factory)
- Export classification: ECCN 3A611.x

HOW TO ORDER

Part Number:	TS8-473
Adapter Series	Battery Eliminator Adapter

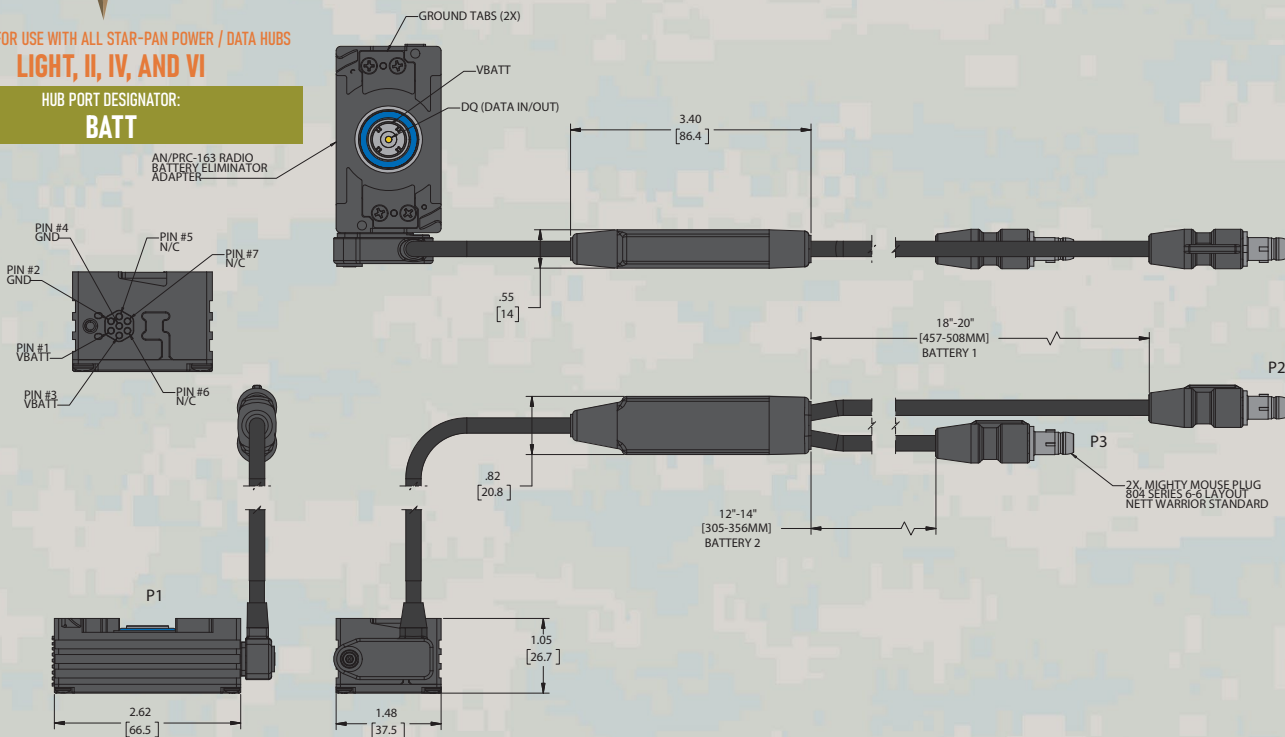

BATTLE-TESTED

STAR-PAN™

Power cables and battery adapters

808-063 PRC-152A, -152, -148 Radio Power Booster



POWER CABLES AND BATTERY ADAPTERS



For Harris AN/PRC-152 / 152A, RF-7800M-HH, RF-7850-TR, L3 TNR, Silvus SC42 / SC44, DTC Radios



QUALIFIED FOR USE WITH ALL STAR-PAN POWER / DATA HUBS LIGHT, II, IV, AND VI

HUB PORT DESIGNATOR:

BATT

RADIO POWER BOOST

SUPPLIED ACCESSORIES

Part Nos. 808-144 and 990-80287

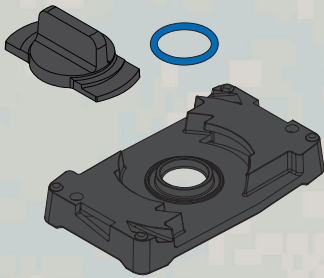

Top Cover and Dust Cover with O-Ring
Rugged black polycarbonate with fluorosilicone O-ring supplied with each assembly

SPECIFICATIONS

- Radio Power Booster enables trickle charging of radio batteries and radio holdup to hub
- Aluminum housing, black zinc-nickel finish
- Overmolded, ergonomic connector strain reliefs, black.
- Santoprene jacketed cable, black
- Mighty Mouse 807 (NATO standard) connector
- Weight: 172g
- Export classification: ECCN 3A611.x

HOW TO ORDER

Part Number:

808-063

Adapter Series

Radio Power Booster

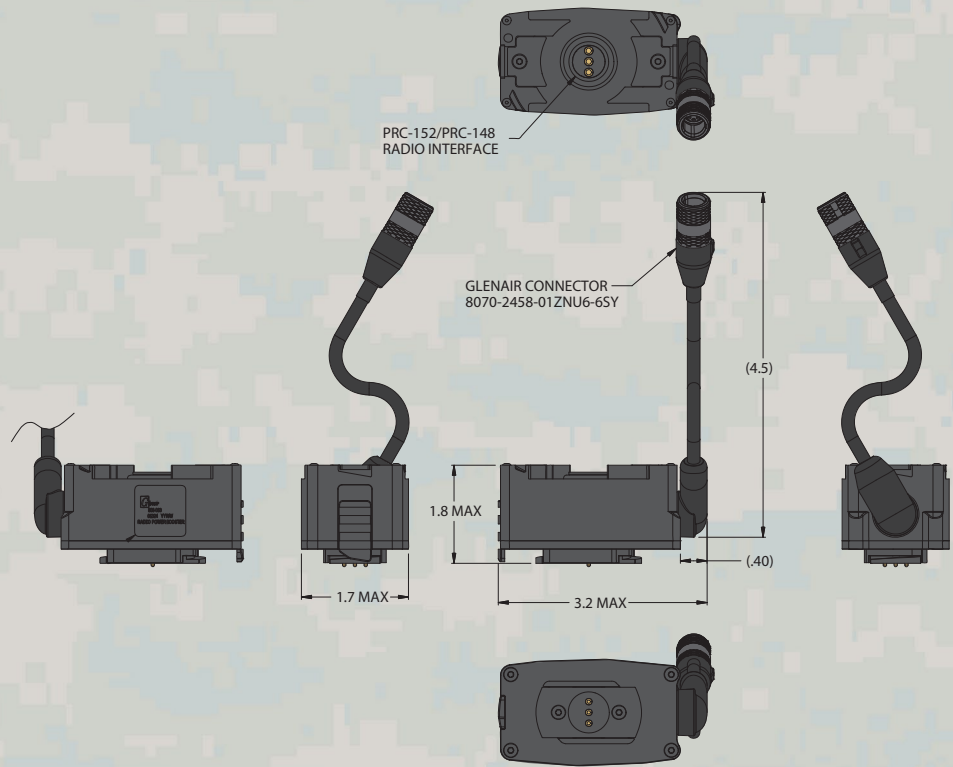

BATTLE-TESTED

STAR-PAN™

Power cables and battery adapters

TS1-067 Cable for use with Radio Battery Adapters

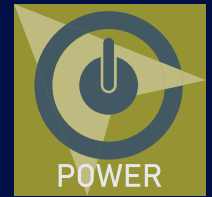

POWER CABLES AND BATTERY ADAPTERS



Radio Battery Adapter cable for TS3-022 and TS8-459

SPECIFICATIONS

- Aluminum housing, black conductive finish
- Santoprene jacketed cable, black
- Weight: (consult factory)
- Export classification: ECCN 3A611.x

HOW TO ORDER

Sample Part Number:

TS1-067

Cable Series

Cable for use with Radio Battery Adapters TS3-022 and TS8-459



QUALIFIED FOR USE WITH ALL STAR-PAN POWER / DATA HUBS

LIGHT, II, IV, AND VI

HUB PORT DESIGNATOR:

BATT

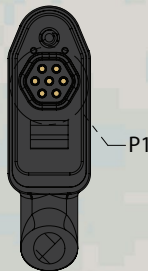

SECTION C-C
SCALE 1 : 1

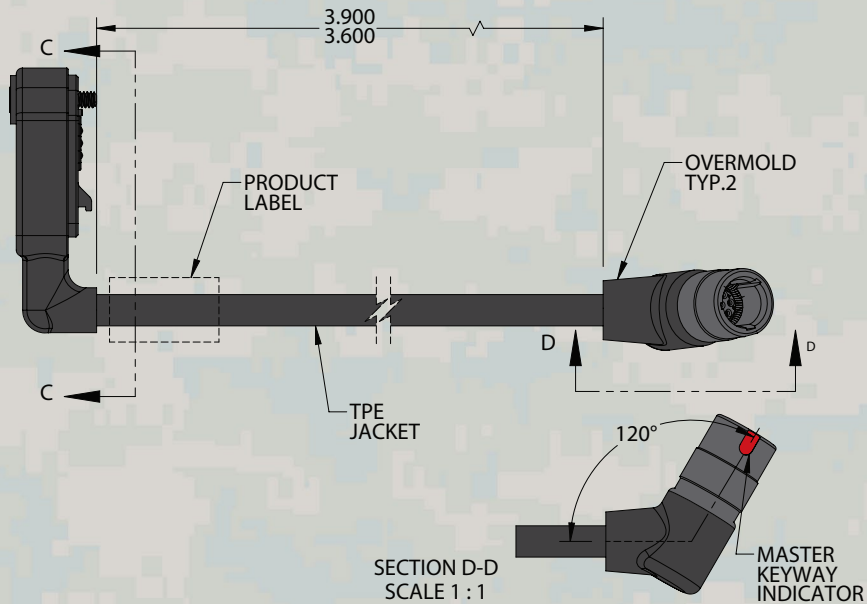

BATTLE-TESTED

STAR-PAN™

Power cables and battery adapters

TS1-030 Cable for use with Radio Battery Adapters



POWER CABLES AND BATTERY ADAPTERS



SPECIFICATIONS

- Aluminum housing, black conductive finish
- Santoprene jacketed cable, black
- Weight: (consult factory)
- Export classification: EAR99

Radio Battery Adapter cable for TS3-022 and TS8-459

HOW TO ORDER

Sample Part Number:	TS1-030	-6	-A
Cable Series	Cable for use with Radio Battery Adapters TS3-022 and TS8-459		
Length	In Inches Omit for standard length of 5.75"		
Retained Screw Option	-A = Thumbscrew at P1 and Thumbscrew at P2 -B = Socket Head at P1 and Thumbscrew at P2 -C = Socket Head at P1 and Socket Head at P2 Omit for Thumbscrew at P1 and Socket Head at P2		
Packaging Option	Omit = Standard packaging -N = No packaging		



QUALIFIED FOR USE WITH ALL STAR-PAN POWER / DATA HUBS LIGHT, II, IV, AND VI

HUB PORT DESIGNATOR:
BATT

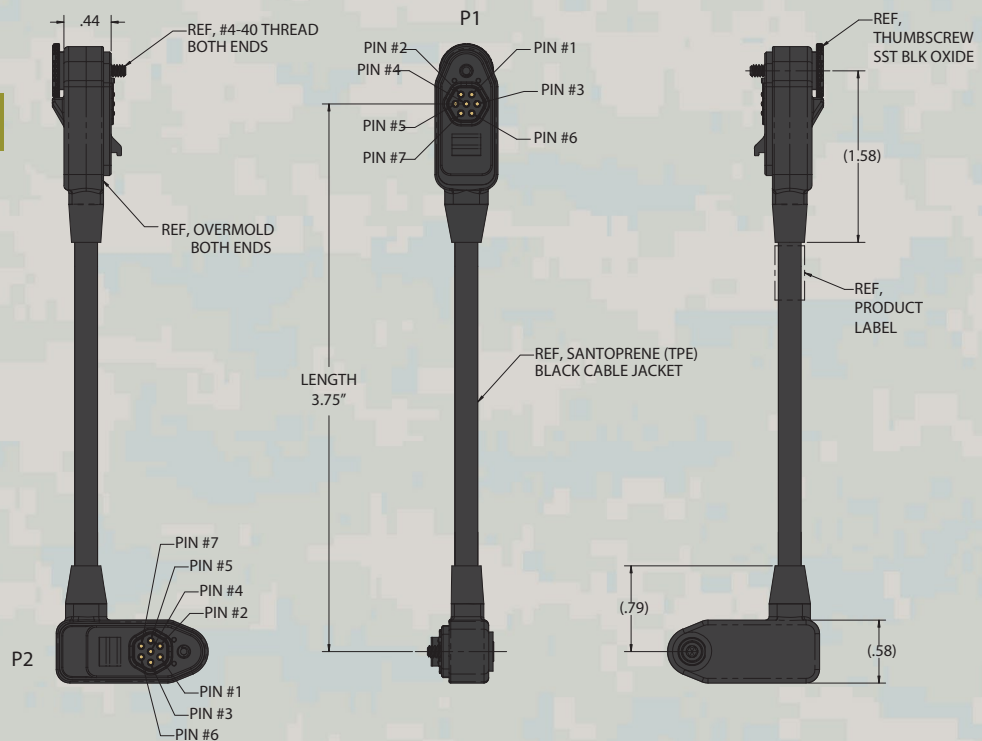

BATTLE-TESTED

STAR-PAN™

Power cables and battery adapters

TS1-073 Cable for use with Radio Battery Adapters



POWER CABLES AND BATTERY ADAPTERS

SPECIFICATIONS

- Aluminum housing, black conductive finish
- Santoprene jacketed cable, black
- Weight: (consult factory)
- Export classification: EAR99

HOW TO ORDER

Sample Part Number:	TS1-073
Cable Series	Cable for use with Radio Battery Adapters
Length Designator	In Inches Omit for standard length of 4"



QUALIFIED FOR USE WITH ALL STAR-PAN POWER / DATA HUBS
LIGHT, II, IV, AND VI

HUB PORT DESIGNATOR:
BATT

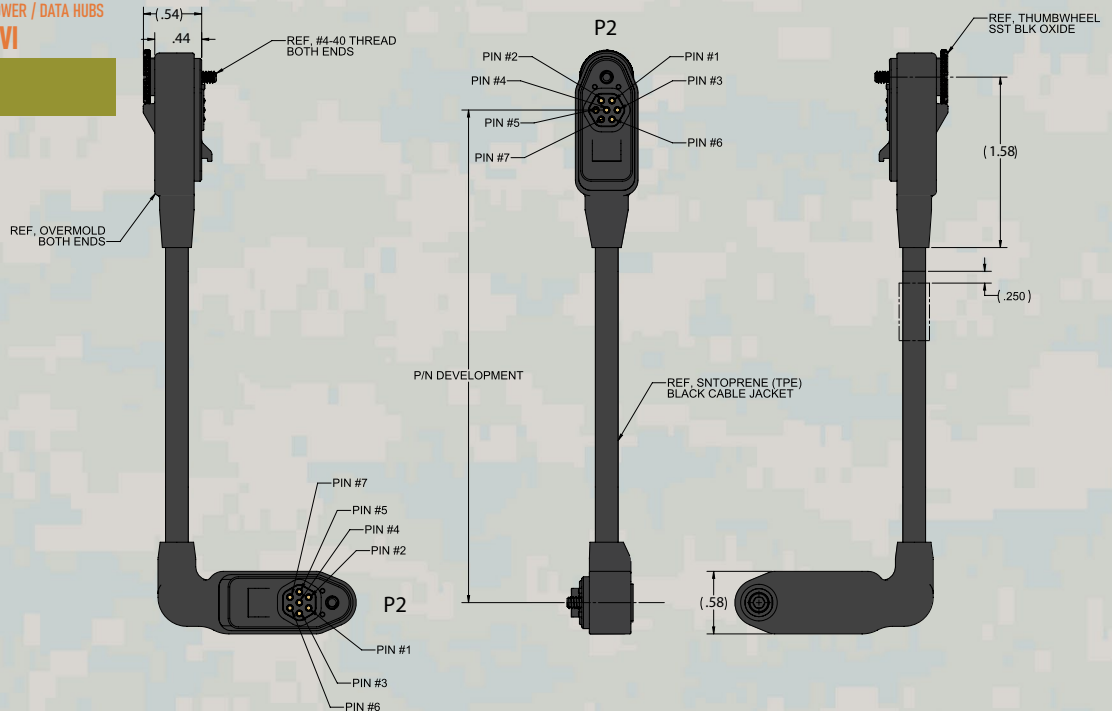

BATTLE-TESTED

STAR-PAN™

Power cables and battery adapters

TS1-045 AN/PRC-163 Dual Charge/Battery Eliminator Cable



POWER CABLES AND BATTERY ADAPTERS

SPECIFICATIONS

- Aluminum housing, black conductive finish
- Santoprene jacketed cable, black
- Weight: (consult factory)
- Export classification: EAR 99

HOW TO ORDER

Sample Part Number:	TS1-045	-S
Cable Series	AN/PRC-163 dual battery charge / battery eliminator cable	
Screw Option	-S = with screw Omit for no screw supplied at P1	



QUALIFIED FOR USE WITH ALL STAR-PAN POWER / DATA HUBS
LIGHT, II, IV, AND VI

HUB PORT DESIGNATOR:
BATT

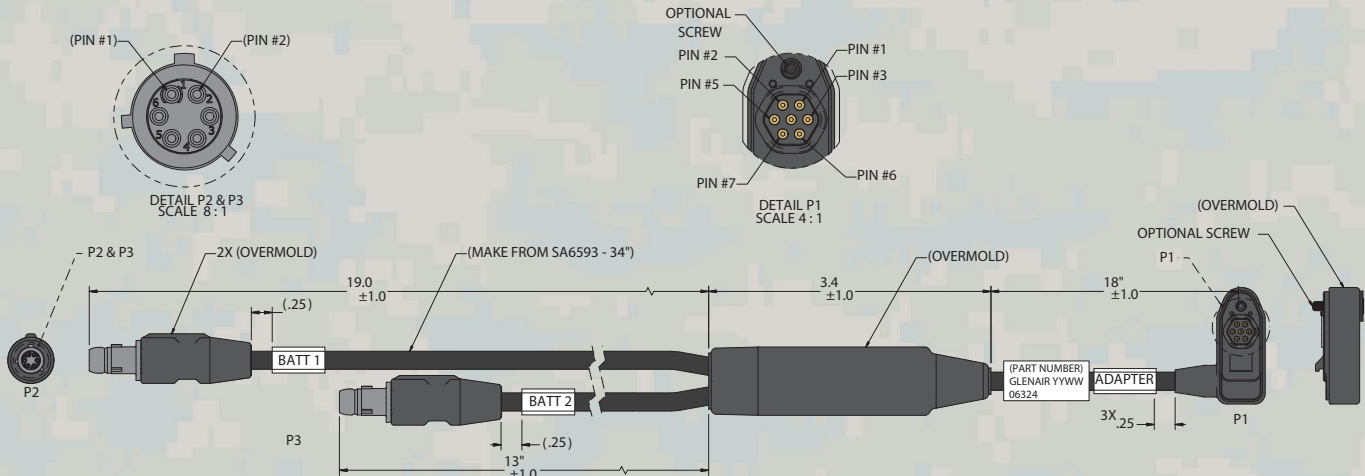

BATTLE-TESTED

STAR-PAN™

Power cables and battery adapters

TS2-003 Power Scavenger



POWER CABLES AND BATTERY ADAPTERS

SPECIFICATIONS

- Energy harvesting from renewable energy sources
- Simultaneous smart battery charging and uninterrupted powering of other devices
- Aluminum housing, black conductive finish
- Weight: (consult factory)
- Export classification: ECCN 3A611.a

HOW TO ORDER

Sample Part Number:

TS2-003

Adapter Series

Power Scavenger



QUALIFIED FOR USE WITH ALL STAR-PAN POWER / DATA HUBS

LIGHT, II, IV, AND VI

HUB PORT DESIGNATOR:

BATT

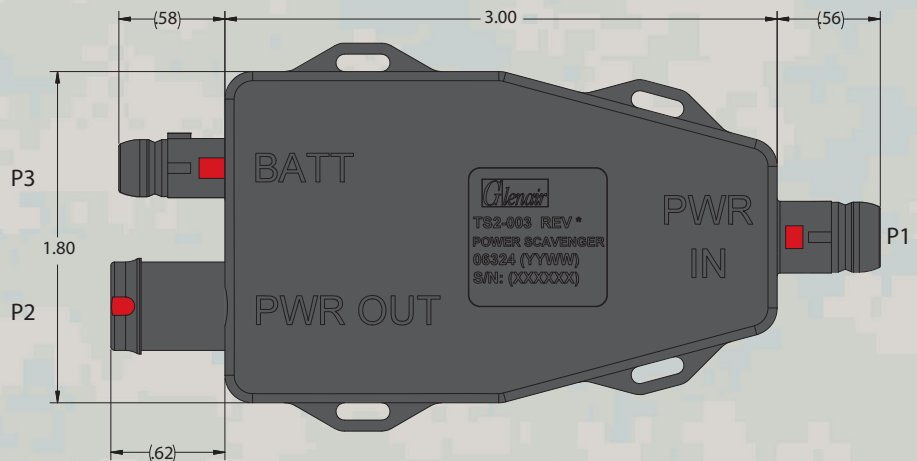

BATTLE-TESTED

STAR-PAN™

Power cables and battery adapters

TS2-009 Power Conditioner



POWER CABLES AND BATTERY ADAPTERS



Power Conditioner

SPECIFICATIONS

- Enables multiple power input options and regulates power for use with STAR-PAN hubs
- Aluminum housing, electroless nickel finish, painted matte tan
- Conductive fluorosilicone housing gasket
- Mighty Mouse 807 (NATO standard) connector [power out] and Mighty Mouse 801 connector [power in]

HOW TO ORDER

Part Number:

TS2-009

Adapter Series

Power Conditioner



QUALIFIED FOR USE WITH ALL STAR-PAN POWER / DATA HUBS
LIGHT, II, IV, AND VI

HUB PORT DESIGNATOR:
AUX or BATT

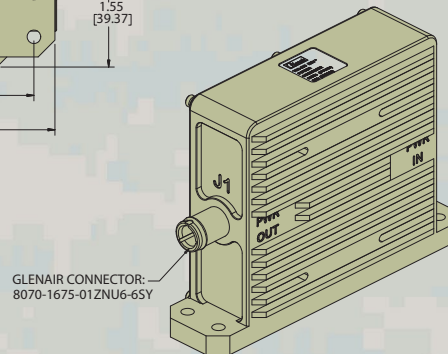
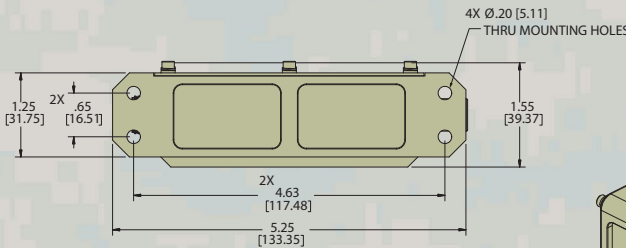
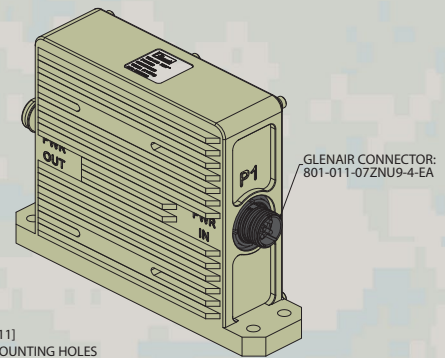
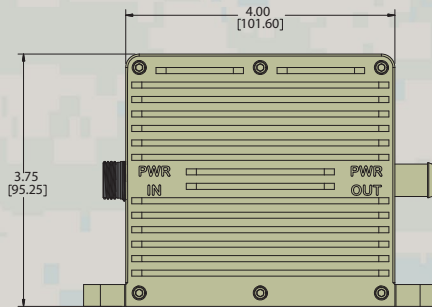

BATTLE-TESTED

STAR-PAN™

Power cables and battery adapters

TS1-093 STAR-PAN X Adapter Cable for TS2-009 Power Conditioner

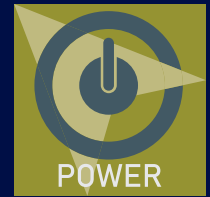

POWER CABLES AND BATTERY ADAPTERS

TS1-093 STAR-PAN X ADAPTER CABLE SPECIFICATIONS

- For connection of STAR-PAN X power / data hubs to TS2-009 Power Conditioner
- Mighty Mouse 801 connector [power in] and Mighty Mouse 807 (NATO standard) connector
- Export classification: EAR 99

HOW TO ORDER

Part Number:	TS1-093	-16
Adapter Series	STAR-PAN X to TS2-009 Power Conditioner adapter cable	
Length Designator	In inches Omit for default length of 10.00"	



QUALIFIED FOR USE WITH ALL STAR-PAN POWER / DATA HUBS
LIGHT, II, IV, AND VI

HUB PORT DESIGNATOR:
BATT

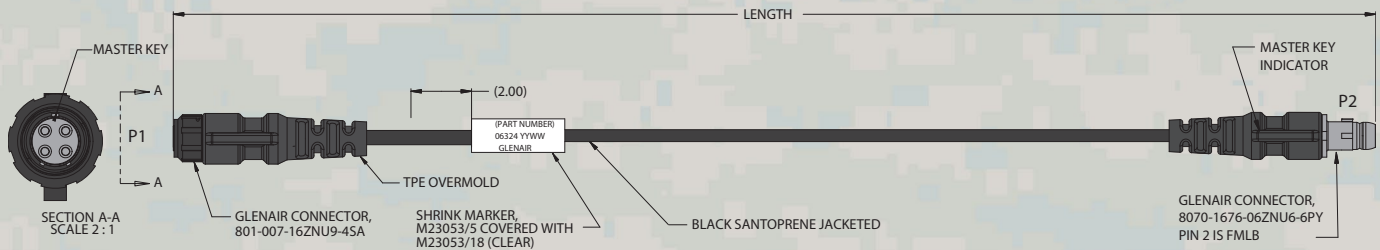

BATTLE-TESTED

STAR-PAN™

Power cables and battery adapters

TS1-053 Automotive Aux Power/Cigarette Lighter Adapter Cable



POWER CABLES AND BATTERY ADAPTERS

SPECIFICATIONS

- For connection of STAR-PAN power / data hubs to vehicle aux power or cigarette lighter with TS2-009 Power Conditioner
- Mighty Mouse 801 connector [power in]
- Export classification: EAR 99

HOW TO ORDER

Part Number:	TS1-053
Adapter Series	Automotive Aux Power/Cigarette Lighter Adapter Cable
Length Designator	In inches Omit for default length of 120.00"



QUALIFIED FOR USE WITH ALL STAR-PAN POWER / DATA HUBS

LIGHT, II, IV, AND VI

HUB PORT DESIGNATOR:

BATT

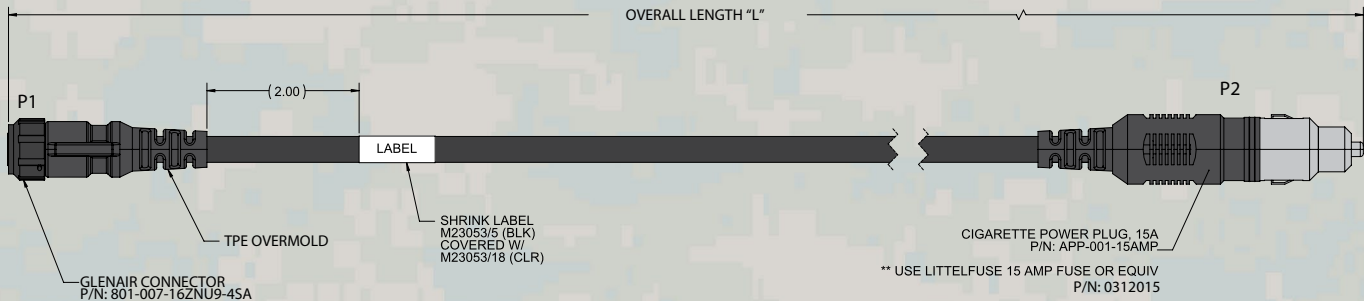

BATTLE-TESTED

STAR-PAN™

Power cables and battery adapters

TS1-054 Mighty Mouse to Battery Clamp Adapter Cable

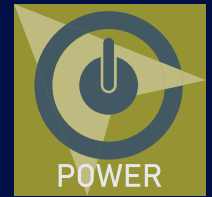

POWER CABLES AND BATTERY ADAPTERS

SPECIFICATIONS

- For connection of STAR-PAN power / data hubs to battery with TS2-009 Power Conditioner
- Mighty Mouse 801 connector [power in]
- Export classification: EAR 99

HOW TO ORDER

Part Number:

TS1-054

Adapter Series

Battery Clamp Adapter Cable



QUALIFIED FOR USE WITH ALL STAR-PAN POWER / DATA HUBS

LIGHT, II, IV, AND VI

HUB PORT DESIGNATOR:

BATT

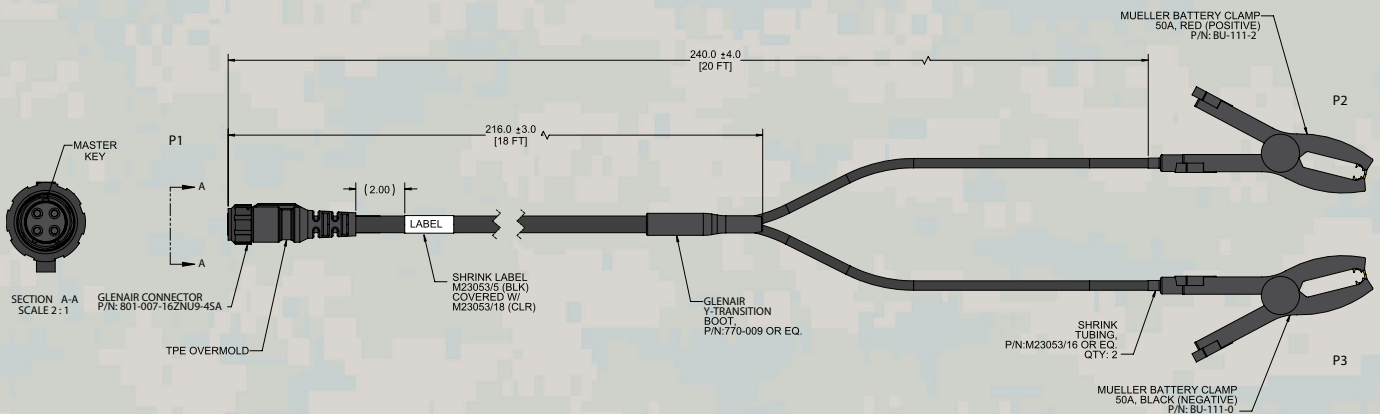

BATTLE-TESTED

STAR-PAN™

Power cables and battery adapters

TS1-055 Mighty Mouse to NATO Plug Adapter Cable



POWER CABLES AND BATTERY ADAPTERS

SPECIFICATIONS

- For connection of STAR-PAN power / data hubs to NATO plug connector with TS2-009 Power Conditioner
- Mighty Mouse 801 connector [power in]
- Export classification: EAR 99

HOW TO ORDER

Part Number:

TS1-055

Adapter Series

NATO Plug Adapter Cable



QUALIFIED FOR USE WITH ALL STAR-PAN POWER / DATA HUBS
LIGHT, II, IV, AND VI

HUB PORT DESIGNATOR:
BATT

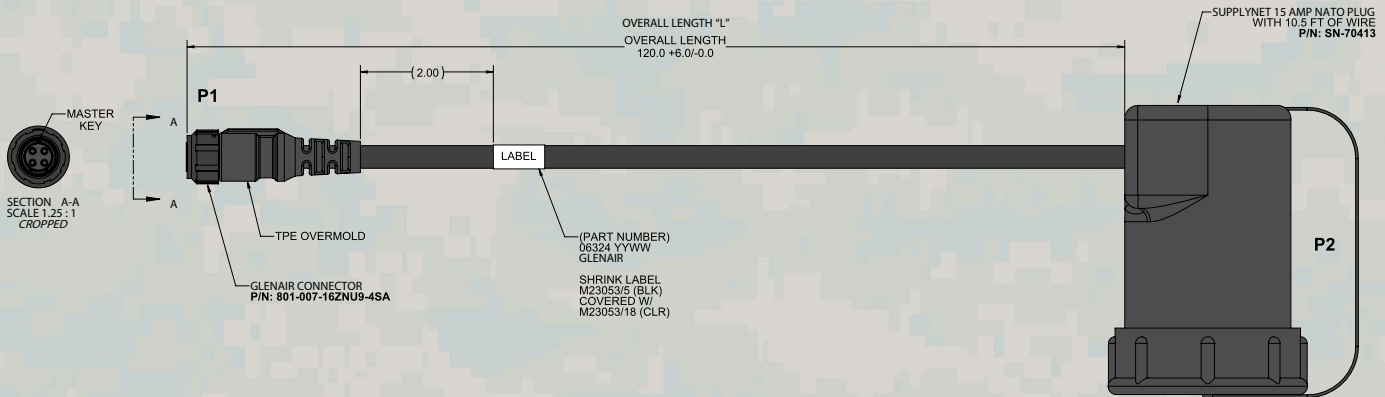

BATTLE-TESTED

STAR-PAN™

Power cables and battery adapters

808-059 Cigarette Lighter Power Adapter Cable

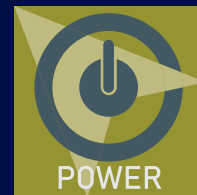

POWER CABLES AND BATTERY ADAPTERS



Cigarette lighter power adapter cable

SPECIFICATIONS

- For connection of STAR-PAN power / data hubs to vehicle cigarette lighter
- Provides conditioned vehicle power
- Mighty Mouse 807 (NATO standard) connector
- Weight, standard 72" cable: 84g
- Export classification: ECCN 3A611.x

HOW TO ORDER

Sample Part Number:

808-059

Cable Series

Cigarette Lighter Power Adapter Cable



QUALIFIED FOR USE WITH ALL STAR-PAN POWER / DATA HUBS

LIGHT, II, IV, AND VI

HUB PORT DESIGNATOR:

AUX or BATT

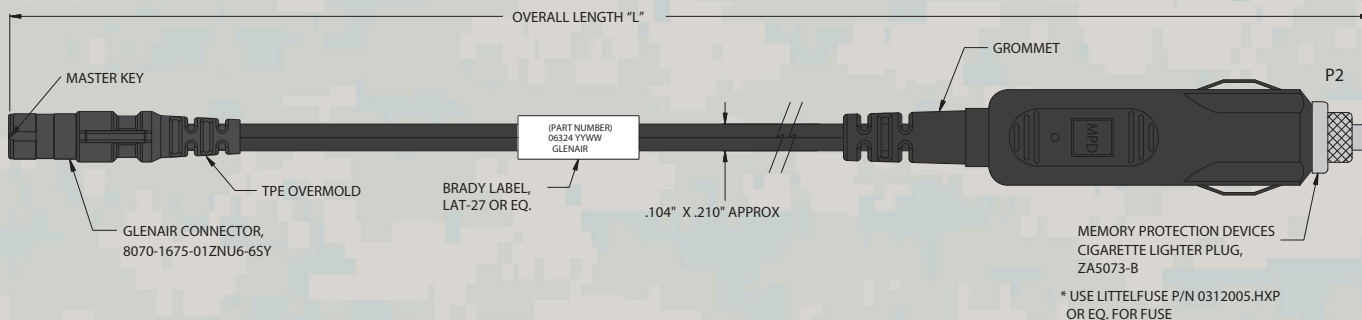

BATTLE-TESTED

STAR-PAN™

Power cables and battery adapters

808-064 AC/DC Power Adapter Cable



POWER CABLES AND BATTERY ADAPTERS



AC/DC power adapter cable

SPECIFICATIONS

- For connection of STAR-PAN power / data hubs to standard power outlets
- Worldwide wall outlet compatibility
- Mighty Mouse 807 (NATO standard) connector
- Weight, 110" cable: 590g
- Export classification: ECCN 3A611.x

HOW TO ORDER

Sample Part Number:	808-064	-EU	-120
Cable Series	AC/DC Power Adapter		
Plug Type Option	US, EU, UK, AU, KR, DM, SW (see code table below)		
Length Designator	In inches Omit for default length of 110.00"		



QUALIFIED FOR USE WITH ALL STAR-PAN POWER / DATA HUBS
LIGHT, II, IV, AND VI

HUB PORT DESIGNATOR:
AUX or BATT

AC Plug Type Option			
Code	P/N	Country / Region	Mating Ref.
US	PCR-B3US-183C	North America (default)	Type B
EU	PCR-B3REU-183B	Europe	Type E/F
UK	PCR-B3UK-183B2	United Kingdom	Type G
AU	PCR-B3AU-183B	Australia	Type I
KR	PCR-BRKR-183B	South Korea	Type F
DM	PCR-B3RDM-183B	Denmark	Type K
SW	PCR-B3SW-183B	Switzerland	Type G

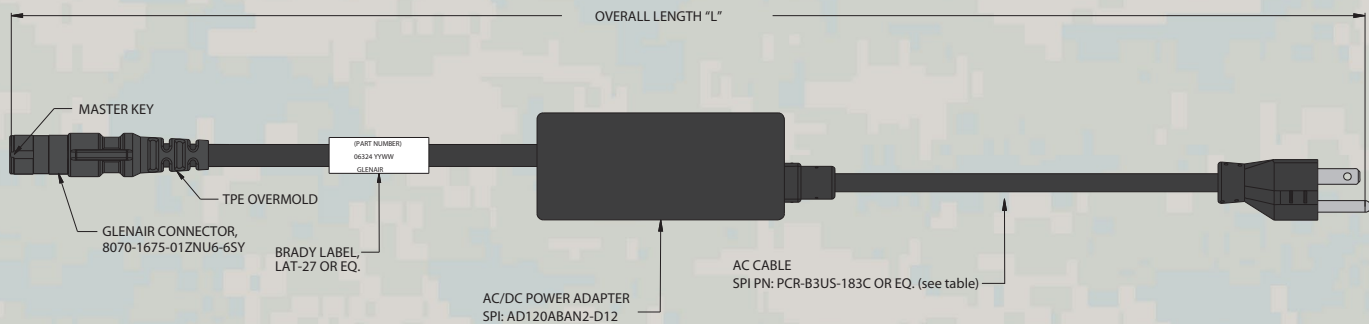

BATTLE-TESTED

STAR-PAN™

Power cables and battery adapters

TS3-060 USB-C PD Downstream Charging Cable

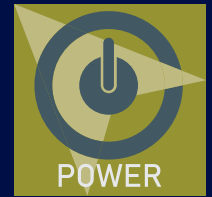

POWER CABLES AND BATTERY ADAPTERS

SPECIFICATIONS

- Places USB-C Power Delivery-capable devices into device mode, and provides a charge current of 2–3A (device and power source-dependent)
- Aluminum housing, black conductive finish
- Santoprene jacketed cable, black, with ergonomic TPE overmolded strain reliefs
- Weight: (consult factory)
- Export classification: ECCN 3A611.x

HOW TO ORDER

Sample Part Number:	TS3-060	-24
Cable Series	USB-C PD downstream charging cable	
Length Option	In Inches. 48.00" max Omit for standard length of 18.00 inches.	



QUALIFIED FOR USE WITH ALL STAR-PAN POWER / DATA HUBS

LIGHT, II, IV, AND VI

HUB PORT DESIGNATOR:

BATT

