

S9407-AB-HBK-010

Conduit Systems for Shipboard Electromagnetic Shielding

RP2620 45° adapter



45° ADAPTER IAW S9407-AB-HBK-010 REV 2, RP2620

How To Order			
Sample Part Number	RP2620	-06	SM
Basic Part Number	Adapter, 45°		
Conduit Size Code	02, 03, 04, 05, 06, 08, 10, 12, 16, 20, 24		
Material / Finish	SN = mild steel with cadmium over electroless nickel finish SM = mild steel with electroless nickel finish IAW AMS 2404C (SM supersedes "no suffix" code reserved for legacy parts)		

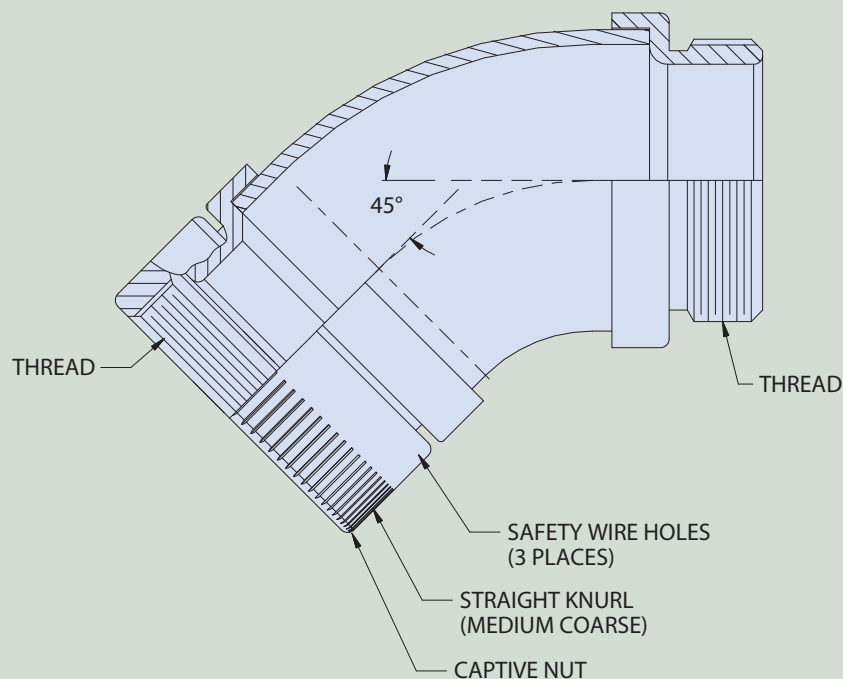

RP2000

MATERIAL / FINISH

Mild Steel AISI Type B1113 IAW Fed-STD-66