

PCB Hole Patterns for Series 791 Connectors

Straight PCB Hole Patterns

PCB Hole Patterns for Straight PCB Series 791 Connectors

PCB hole patterns are shown for the *component mounting side* of the circuit board. The dotted line shows the orientation of the connector shell.

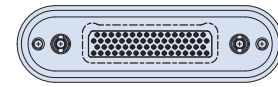

Top View

A-5 Arrangement

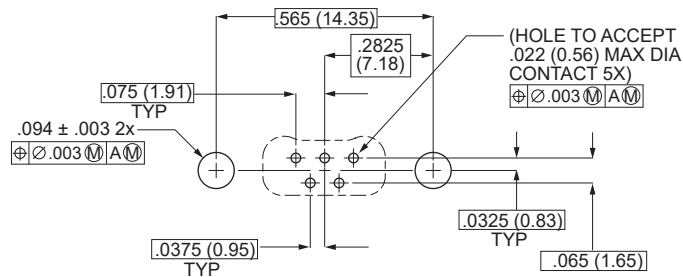

B-2P2 Arrangement

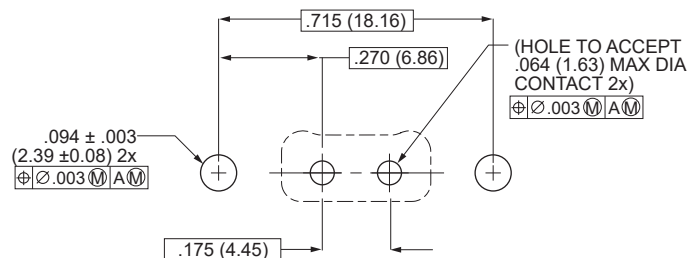
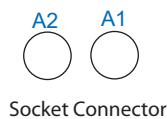
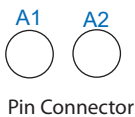

B-9 Arrangement

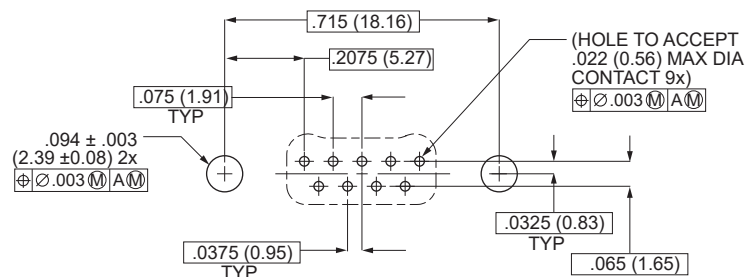

C-13 Arrangement

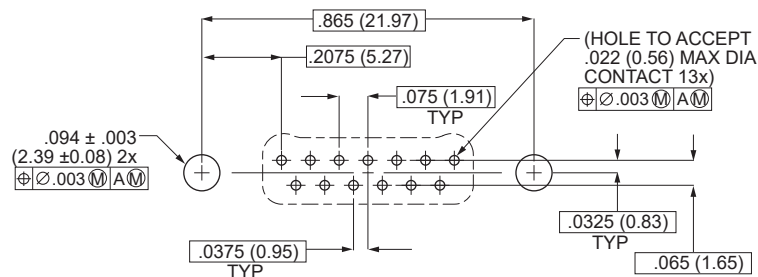

PCB Hole Patterns for Series 791 Connectors

Straight PCB Hole Patterns

PCB Hole Patterns for Straight PCB Series 791 Connectors

PCB hole patterns are shown for the *component mounting side* of the circuit board. The dotted line shows the orientation of the connector shell.

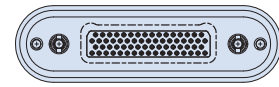

Top View

D-15 Arrangement



Pin Connector



Socket Connector

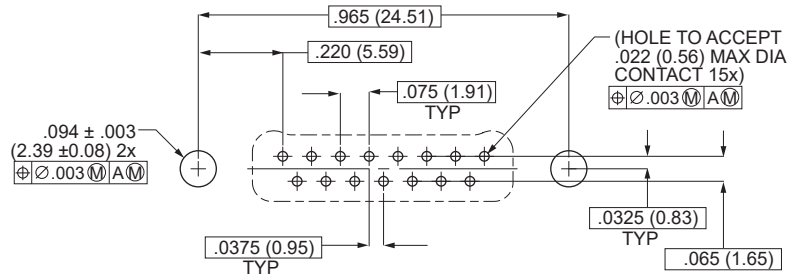

D-3P3 Arrangement

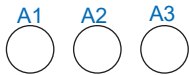

Pin Connector

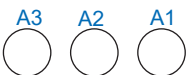

Socket Connector

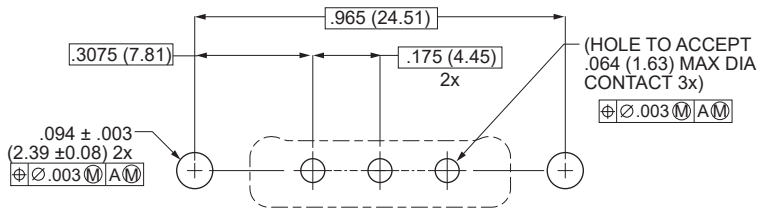

D-7P2 Arrangement

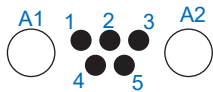

Pin Connector

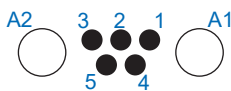

Socket Connector

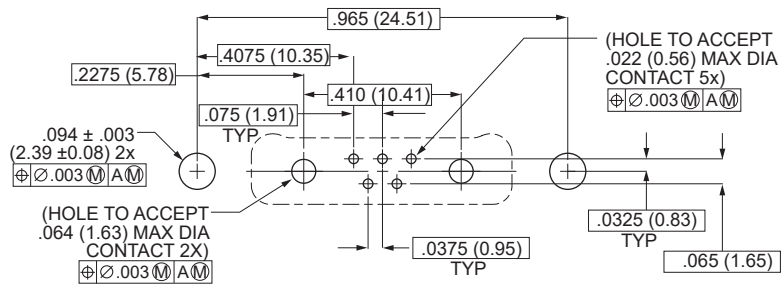

E-11P2 Arrangement



Pin Connector



Socket Connector

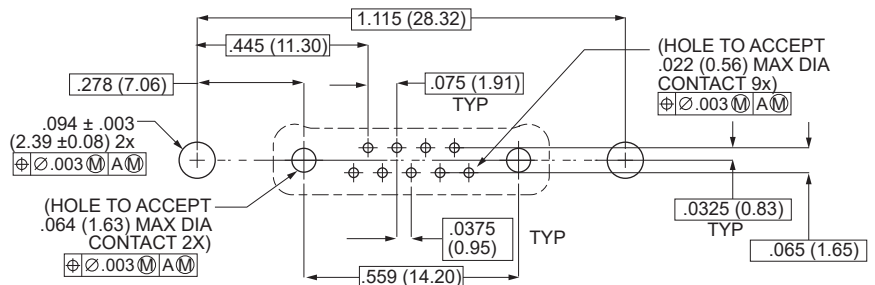

PCB Hole Patterns for Series 791 Connectors

Straight PCB Hole Patterns

PCB Hole Patterns for Straight PCB Series 791 Connectors

PCB hole patterns are shown for the *component mounting side* of the circuit board. The dotted line shows the orientation of the connector shell.

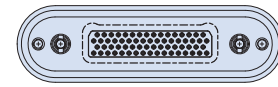

Top View

E-19 Arrangement



Pin Connector



Socket Connector

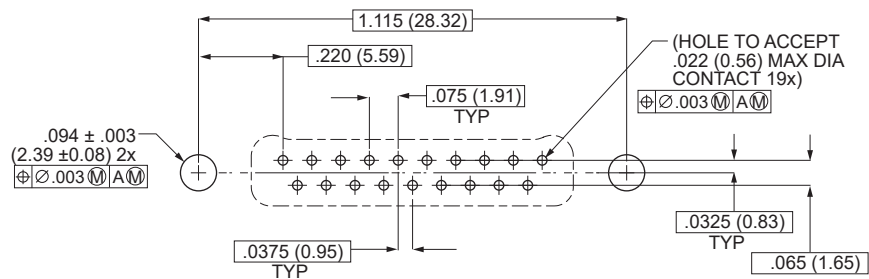

E-7P3 Arrangement

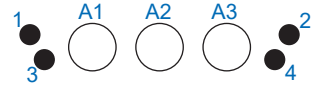

Pin Connector

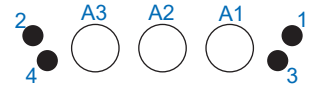

Socket Connector

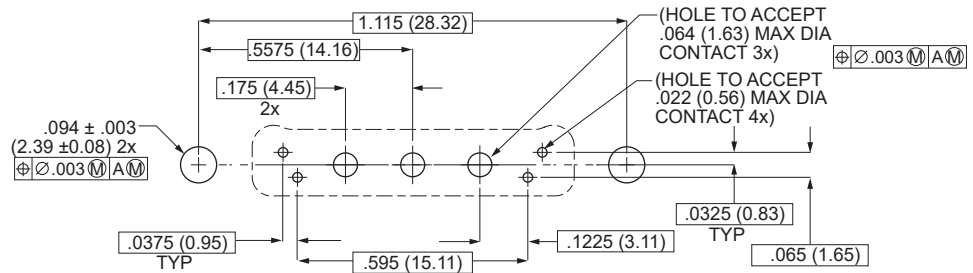

F-14P3P Arrangement

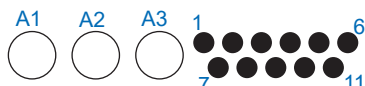

Pin Connector

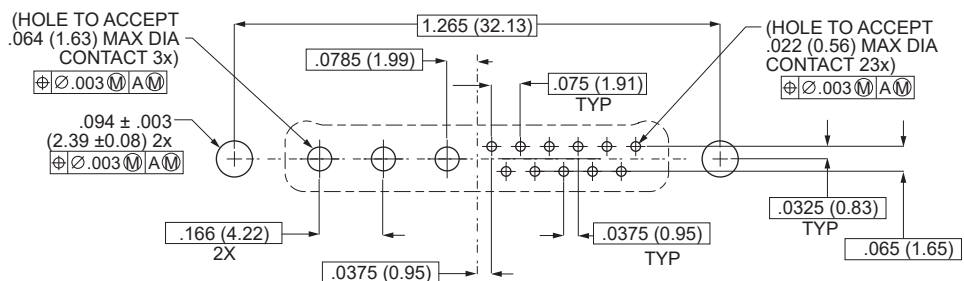

F-14P3S Arrangement

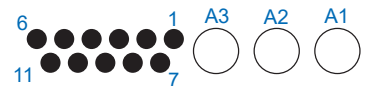

Socket Connector

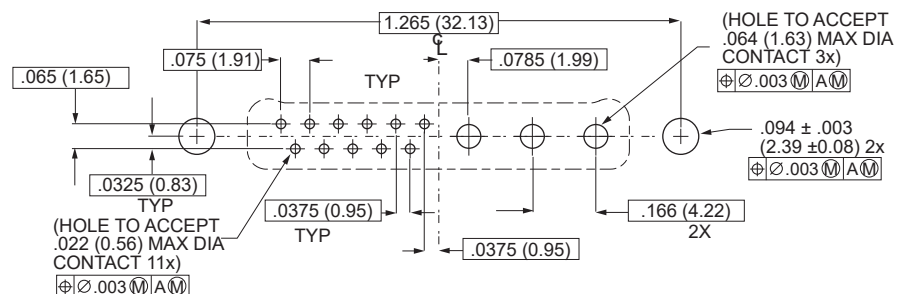

PCB Hole Patterns for Series 791 Connectors

Straight PCB Hole Patterns

PCB Hole Patterns for Straight PCB Series 791 Connectors

PCB hole patterns are shown for the *component mounting side* of the circuit board. The dotted line shows the orientation of the connector shell.

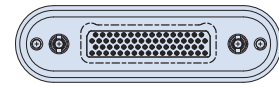

Top View

F-15P2 Arrangement

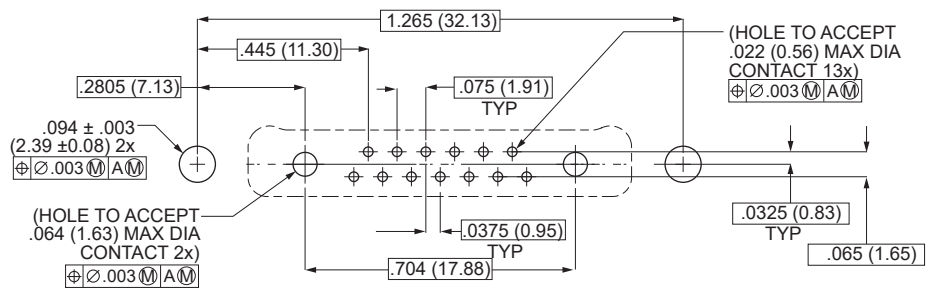
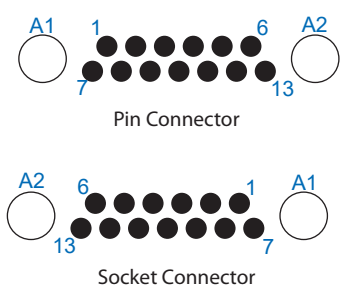

F-23 Arrangement

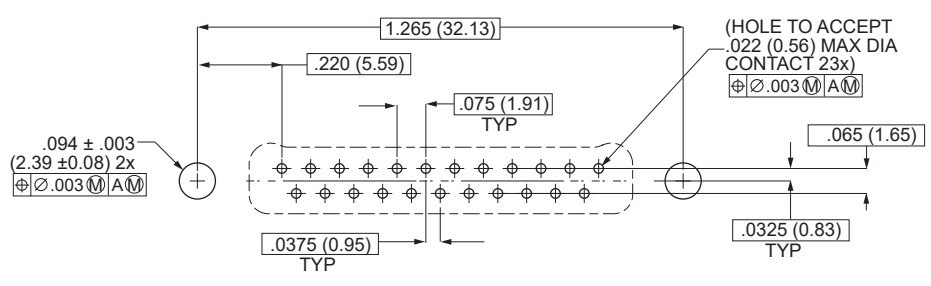
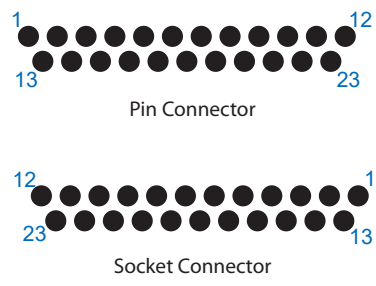

F-5P5 Arrangement

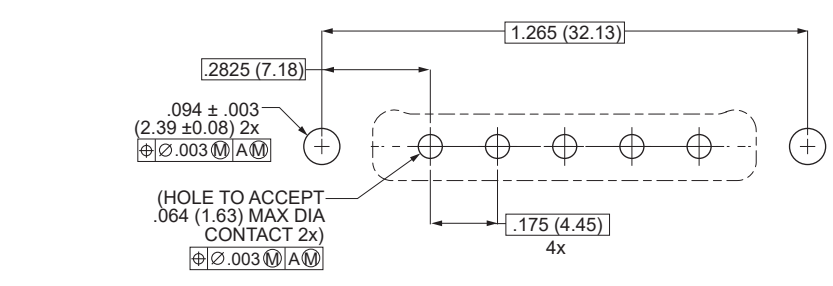
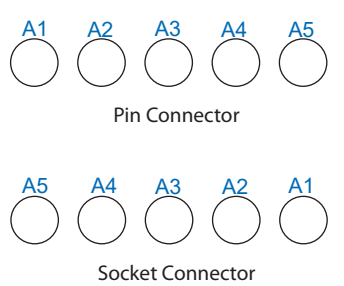

G-13P2 Arrangement

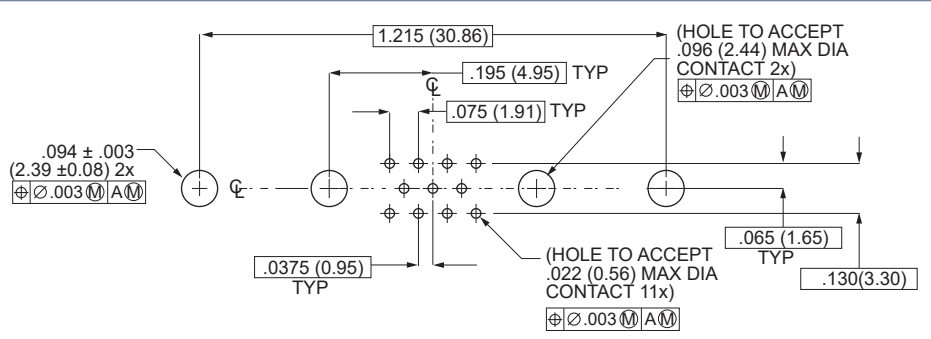
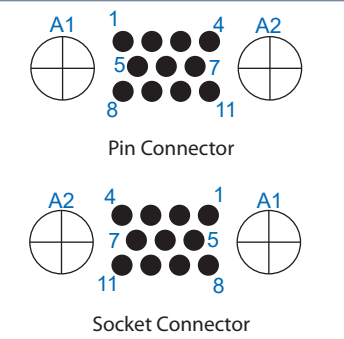

PCB Hole Patterns for Series 791 Connectors

Straight PCB Hole Patterns

PCB Hole Patterns for Straight PCB Series 791 Connectors

PCB hole patterns are shown for the *component mounting side* of the circuit board. The dotted line shows the orientation of the connector shell.

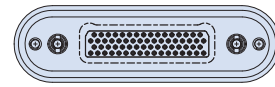

Top View

G-21P1 Arrangement

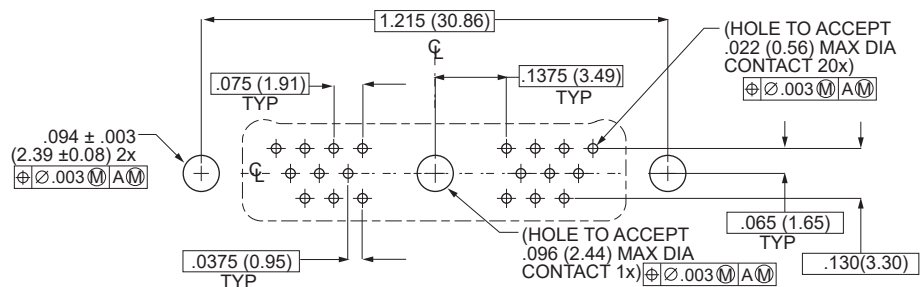
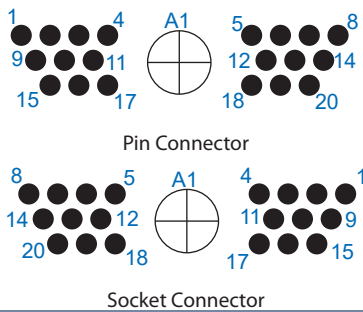

G-33 Arrangement

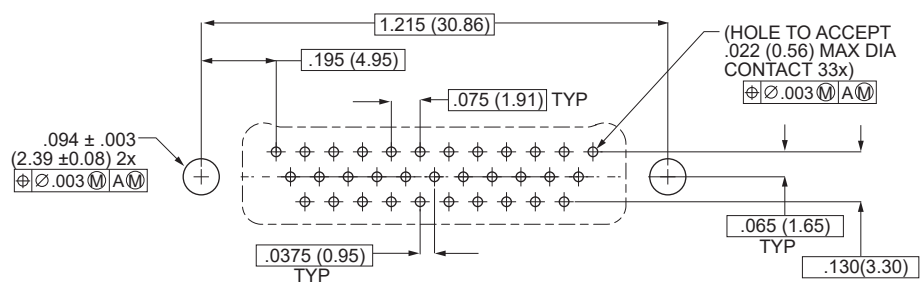
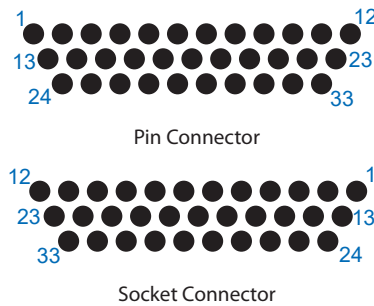

G-3P3 Arrangement

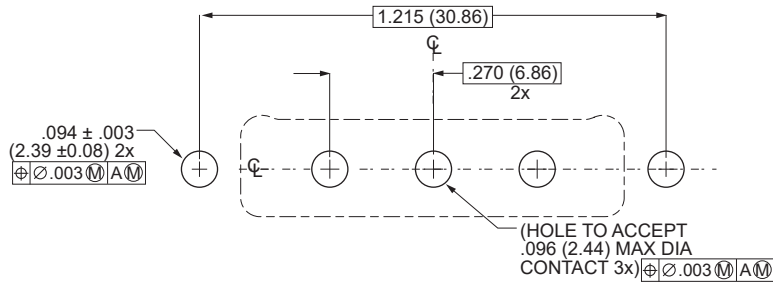
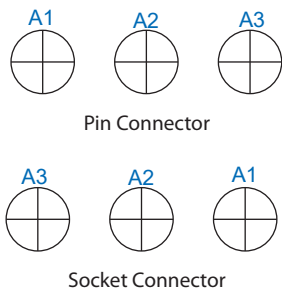

H-10P4 Arrangement

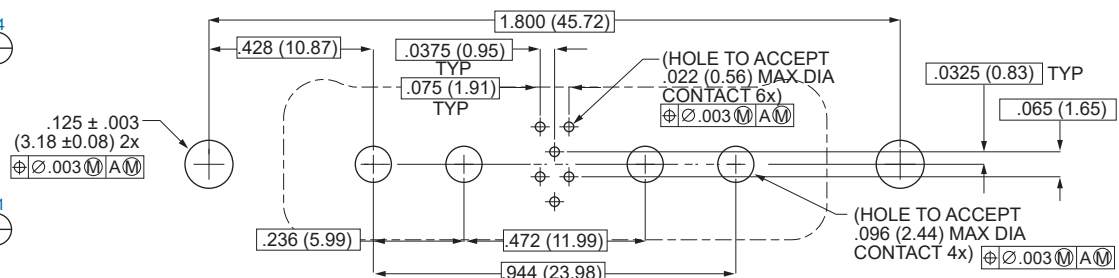
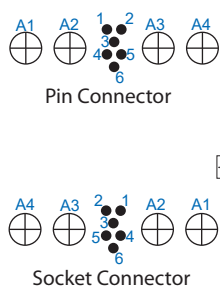

PCB Hole Patterns for Series 791 Connectors

Straight PCB Hole Patterns

PCB Hole Patterns for Straight PCB Series 791 Connectors

PCB hole patterns are shown for the *component mounting side* of the circuit board. The dotted line shows the orientation of the connector shell.

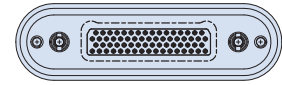

Top View

H-29P7 Arrangement

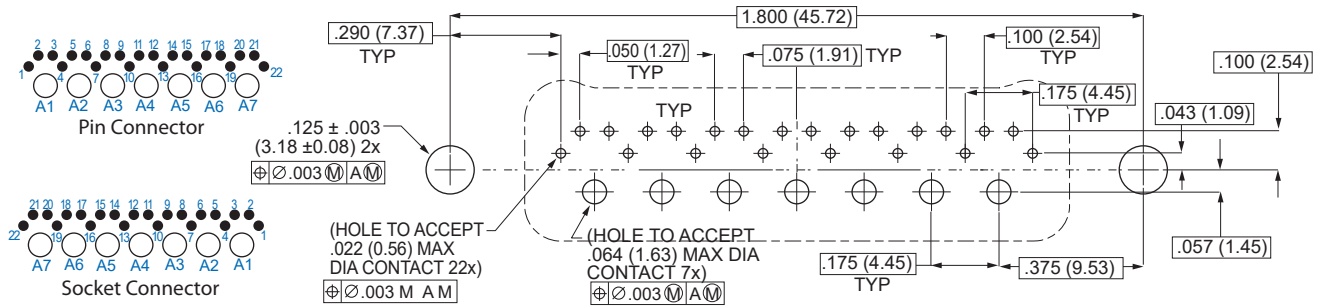

H-36P2 Arrangement

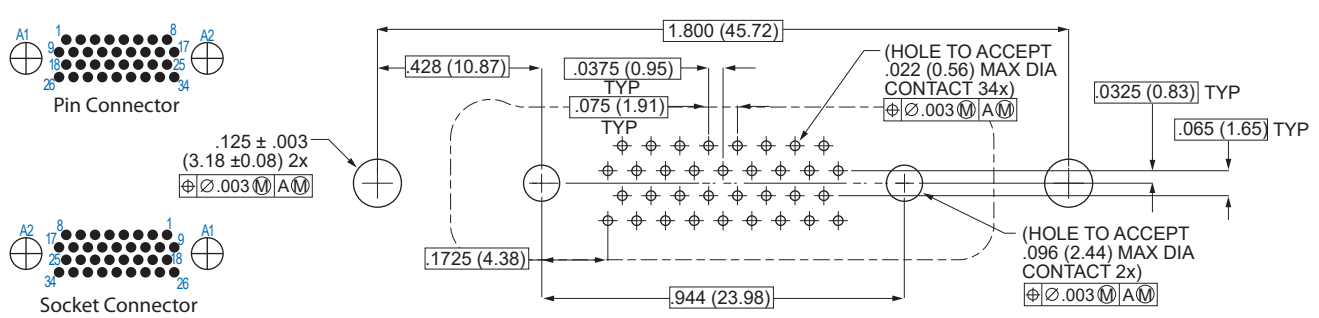

H-54P2 Arrangement

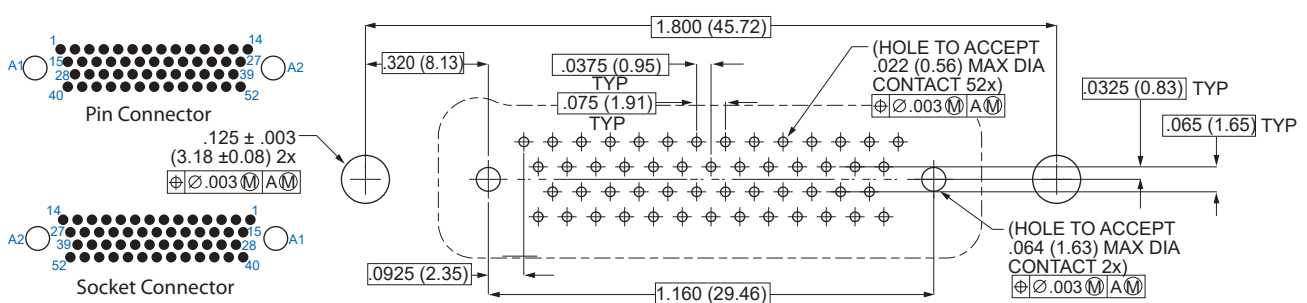

H-5P5 Arrangement

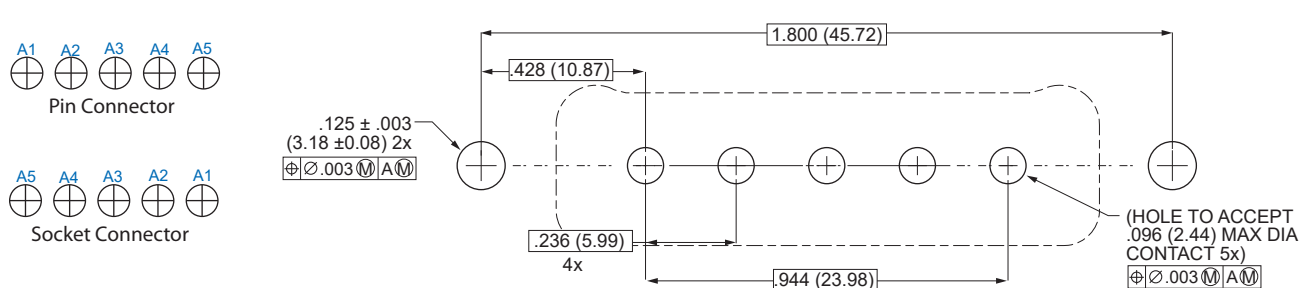

PCB Hole Patterns for Series 791 Connectors

Straight PCB Hole Patterns

PCB Hole Patterns for Straight PCB Series 791 Connectors

PCB hole patterns are shown for the *component mounting side* of the circuit board. The dotted line shows the orientation of the connector shell.

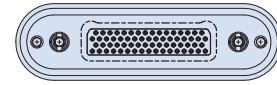

Top View

H-66 Arrangement

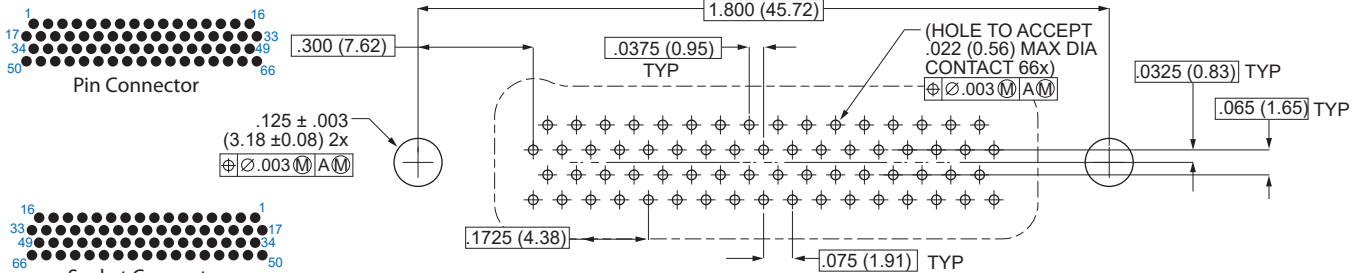

J-17P4 Arrangement

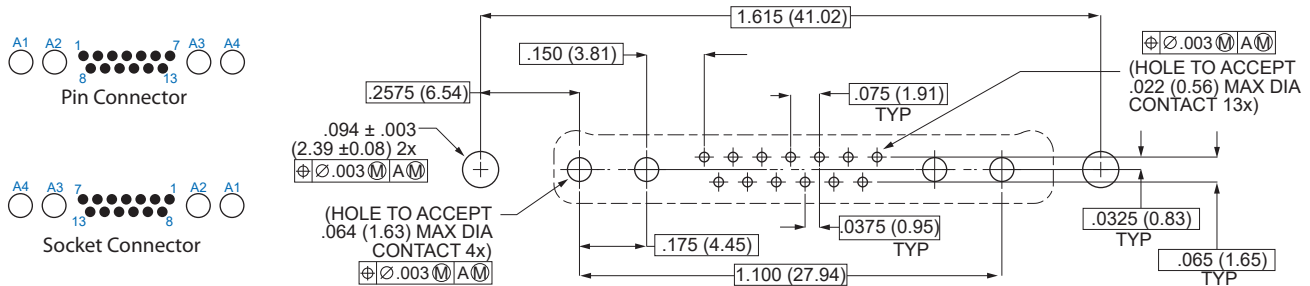

J-25P2 Arrangement

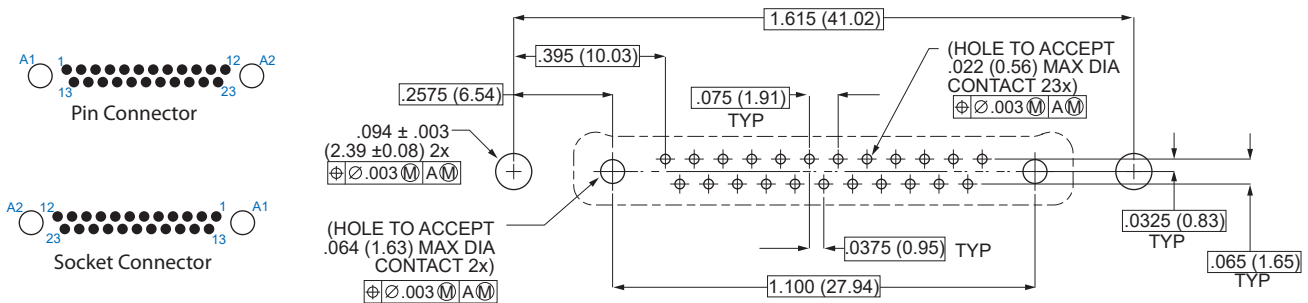

J-33 Arrangement

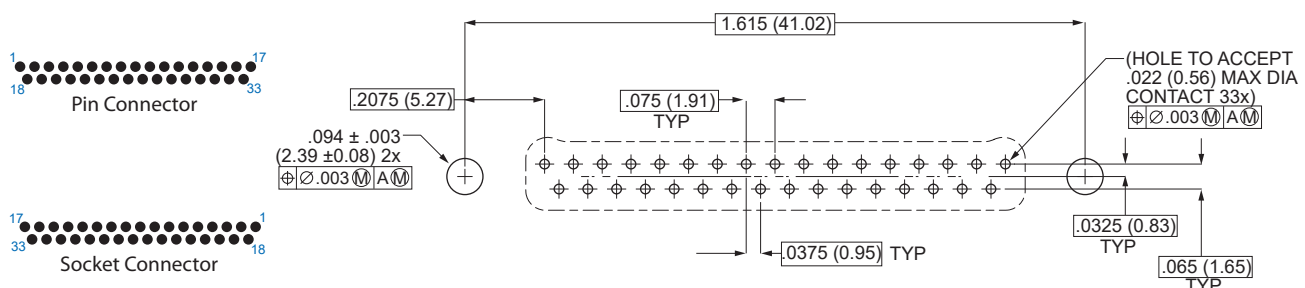

PCB Hole Patterns for Series 791 Connectors

Straight PCB Hole Patterns

PCB Hole Patterns for Straight PCB Series 791 Connectors

PCB hole patterns are shown for the *component mounting side* of the circuit board. The dotted line shows the orientation of the connector shell.

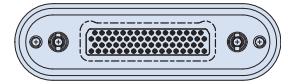

J-7P7 Arrangement

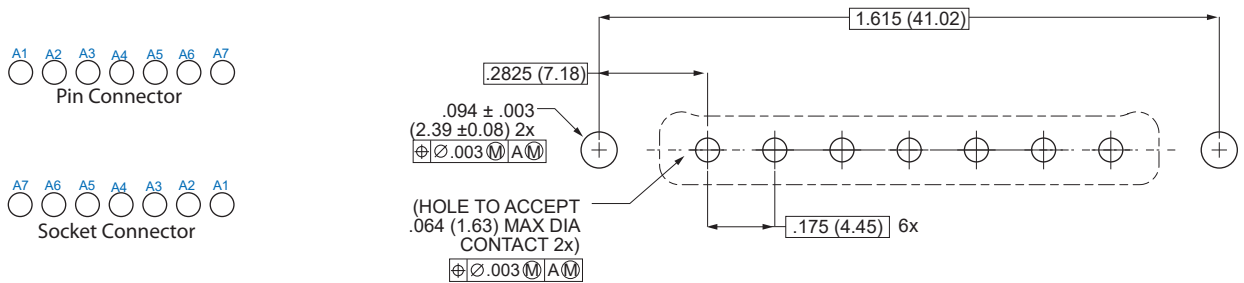

K-27P4 Arrangement

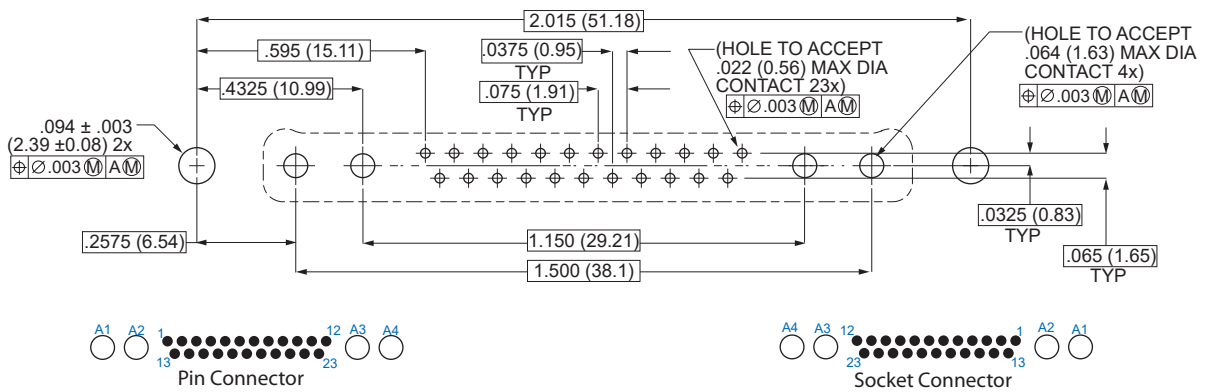

K-35P2 Arrangement

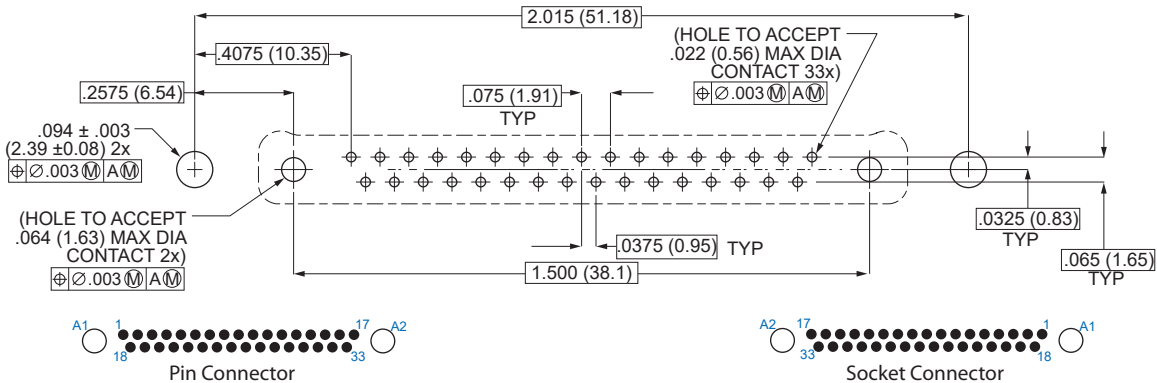

PCB Hole Patterns for Series 791 Connectors

Straight PCB Hole Patterns

PCB Hole Patterns for Straight PCB Series 791 Connectors

PCB hole patterns are shown for the *component mounting side* of the circuit board. The dotted line shows the orientation of the connector shell.

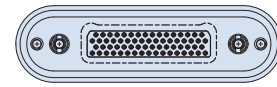

Top View

K-43 Arrangement

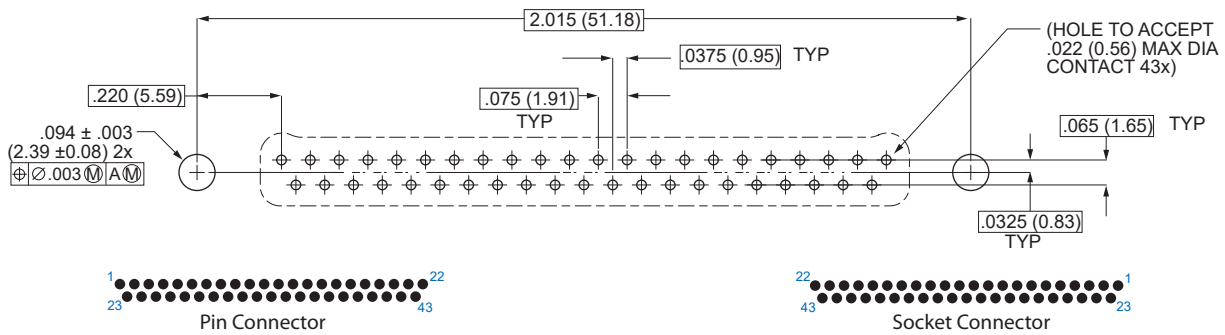

K-9P9 Arrangement

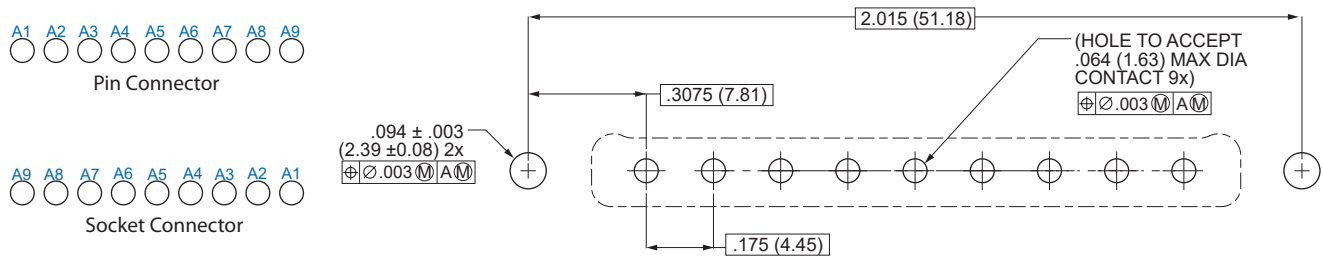

L-6P6 Arrangement

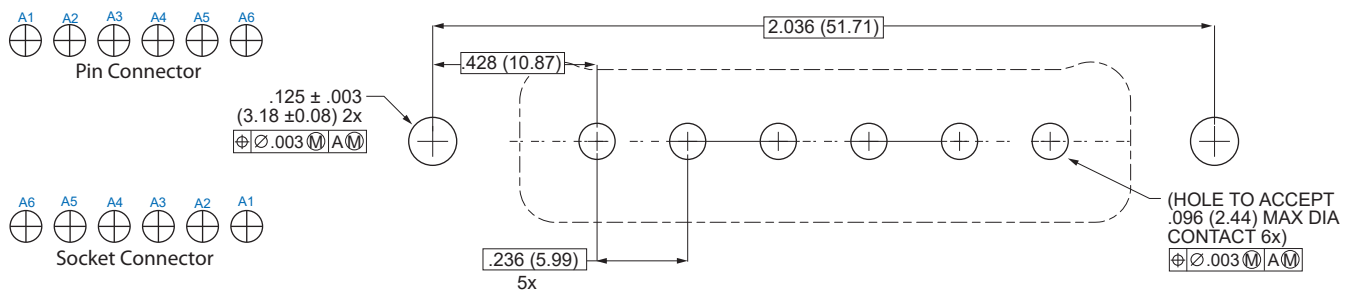

PCB Hole Patterns for Series 791 Connectors

Straight PCB Hole Patterns

PCB Hole Patterns for Straight PCB Series 791 Connectors

PCB hole patterns are shown for the *component mounting side* of the circuit board. The dotted line shows the orientation of the connector shell.

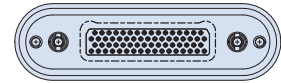

L-78 Arrangement

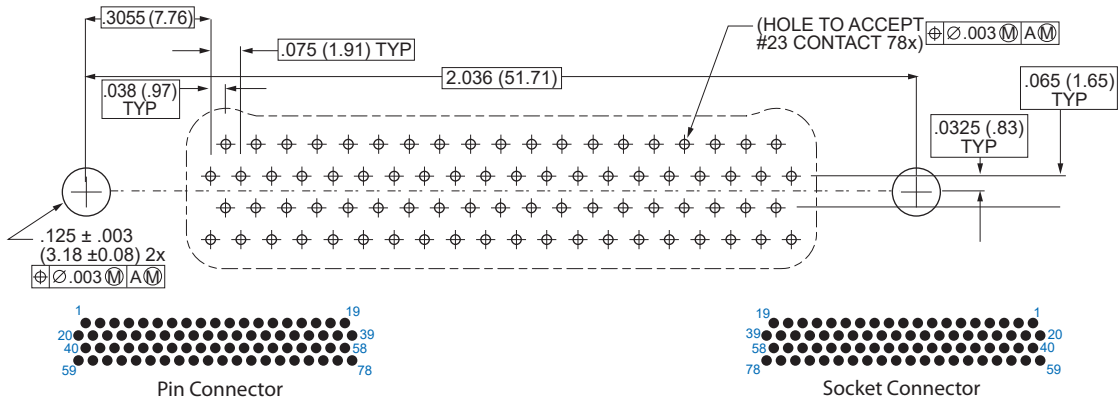

M-102 Arrangement

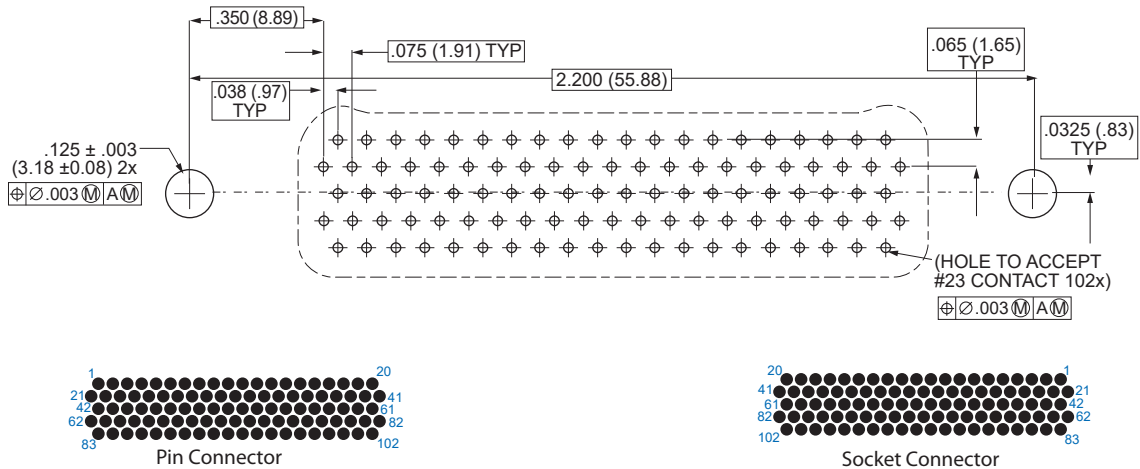

PCB Hole Patterns for Series 791 Connectors

Straight PCB Hole Patterns

PCB Hole Patterns for Straight PCB Series 791 Connectors

PCB hole patterns are shown for the *component mounting side* of the circuit board. The dotted line shows the orientation of the connector shell.

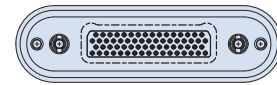

Top View

M-17P17 Arrangement

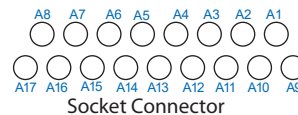
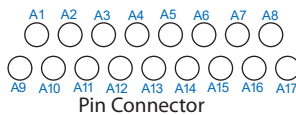
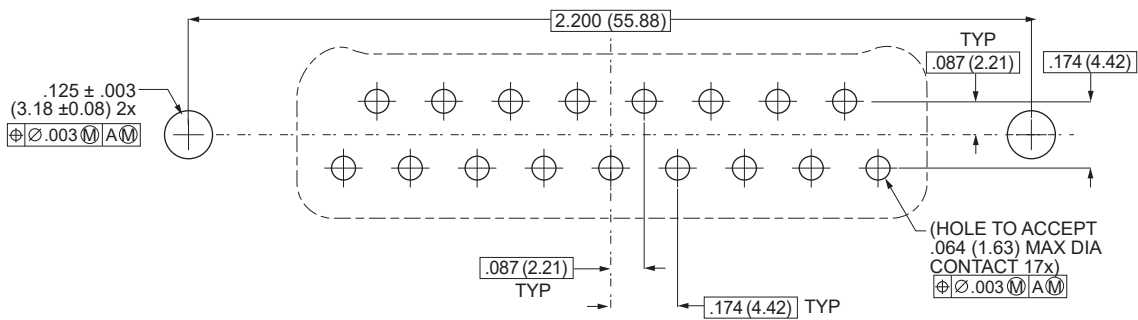

M-4P4 Arrangement

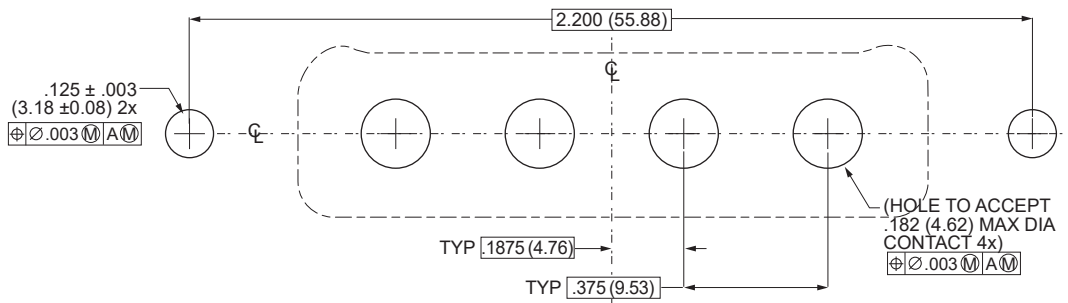

PCB Hole Patterns for Series 791 Connectors

Right Angle PCB Hole Patterns

PCB Hole Patterns for Right Angle Series 79 Connectors

Right angle PCB hole patterns are shown for the *component mounting side* of the circuit board. Connector orientation is shown in the illustration to the right with the connector facing up.

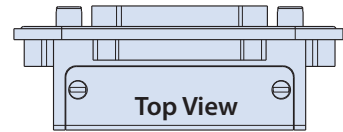

A-5 Arrangement

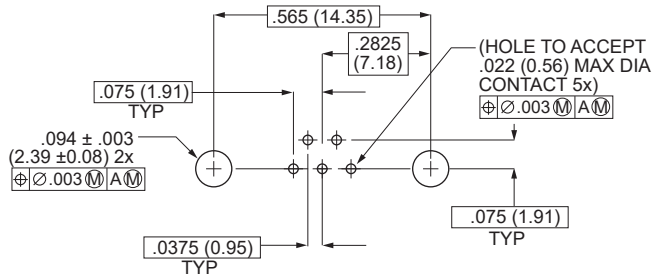

B-2P2 Arrangement

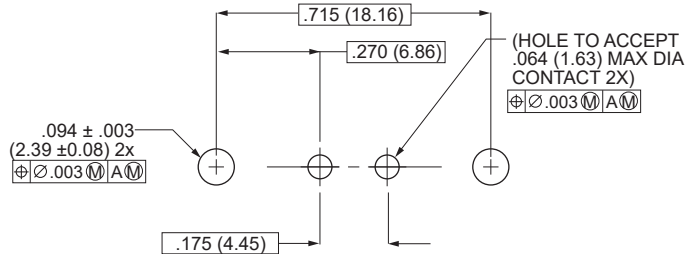

B-9 Arrangement

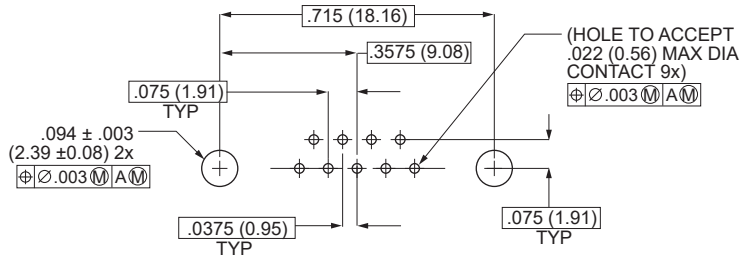

C-13 Arrangement

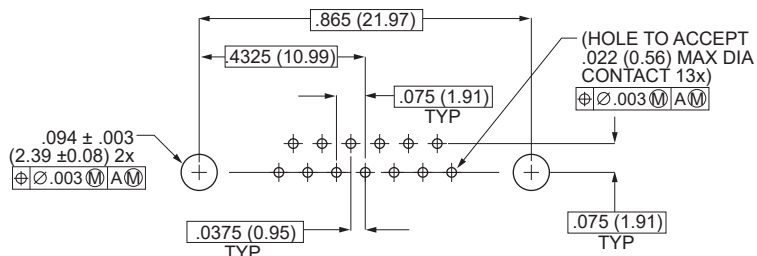
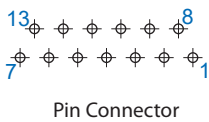

PCB Hole Patterns for Series 791 Connectors

Right Angle PCB Hole Patterns

PCB Hole Patterns for Right Angle Series 79 Connectors

Right angle PCB hole patterns are shown for the *component mounting side* of the circuit board. Connector orientation is shown in the illustration to the right with the connector facing up.

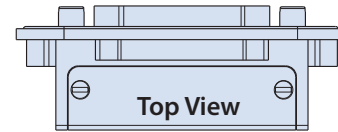

D-15 Arrangement



Pin Connector



Socket Connector

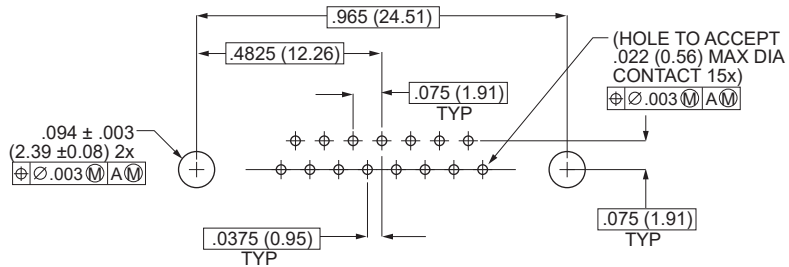

D-3P3 Arrangement



Pin Connector



Socket Connector

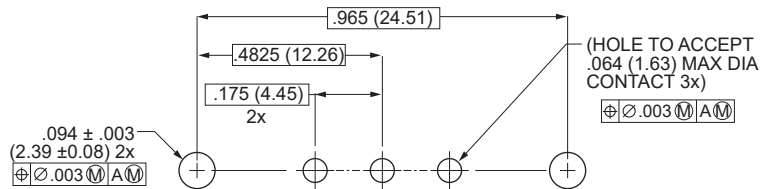

D-7P2 Arrangement



Pin Connector



Socket Connector

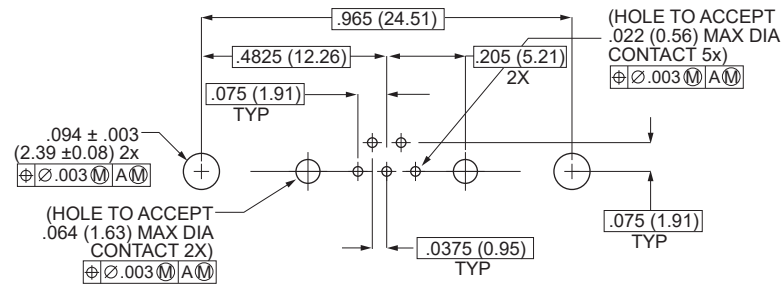

E-11P2 Arrangement



Pin Connector



Socket Connector

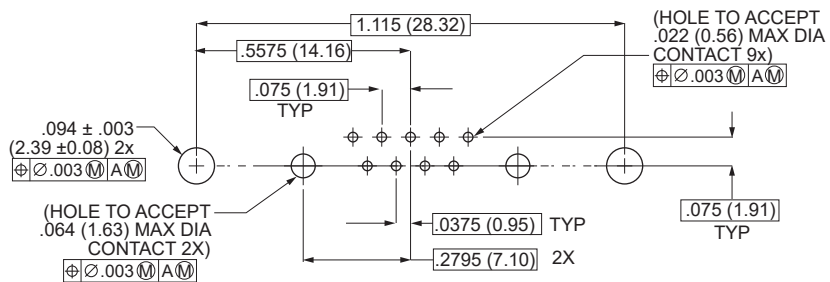

PCB Hole Patterns for Series 791 Connectors

Right Angle PCB Hole Patterns

PCB Hole Patterns for Right Angle Series 79 Connectors

Right angle PCB hole patterns are shown for the *component mounting side* of the circuit board. Connector orientation is shown in the illustration to the right with the connector facing up.

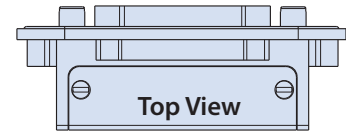

E-19 Arrangement



Pin Connector



Socket Connector

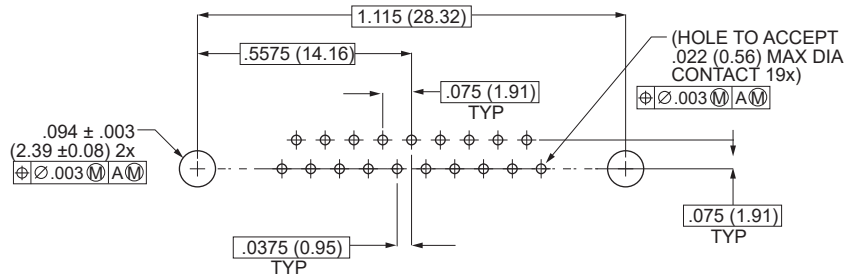

E-7P3 Arrangement



Pin Connector

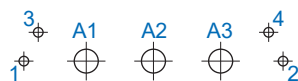

Socket Connector

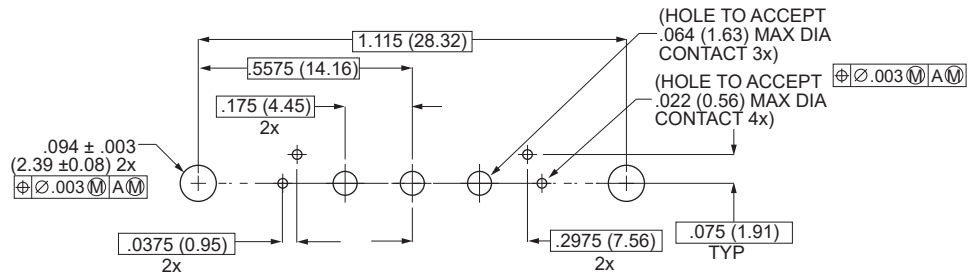

F-14P3P Arrangement



Pin Connector

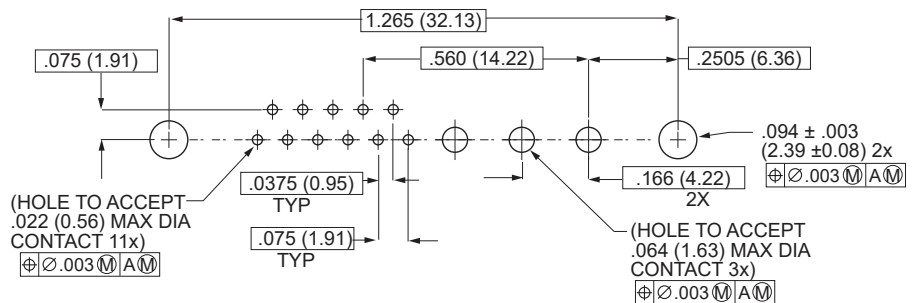

F-14P3S Arrangement

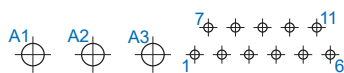

Socket Connector

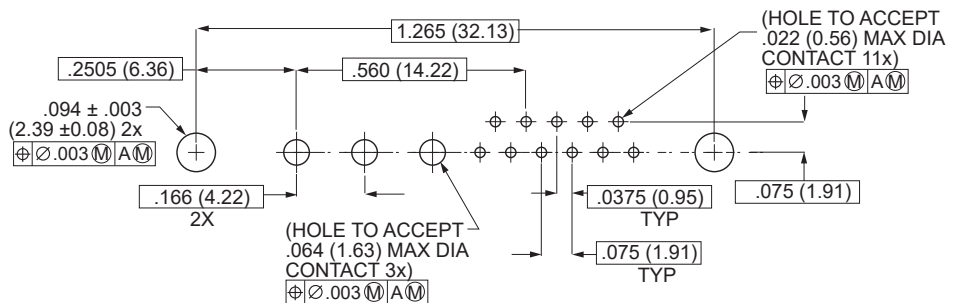

PCB Hole Patterns for Series 791 Connectors

Right Angle PCB Hole Patterns

PCB Hole Patterns for Right Angle Series 79 Connectors

Right angle PCB hole patterns are shown for the *component mounting side* of the circuit board. Connector orientation is shown in the illustration to the right with the connector facing up.

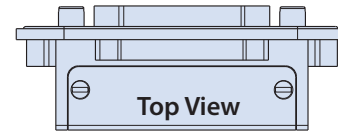

F-15P2 Arrangement

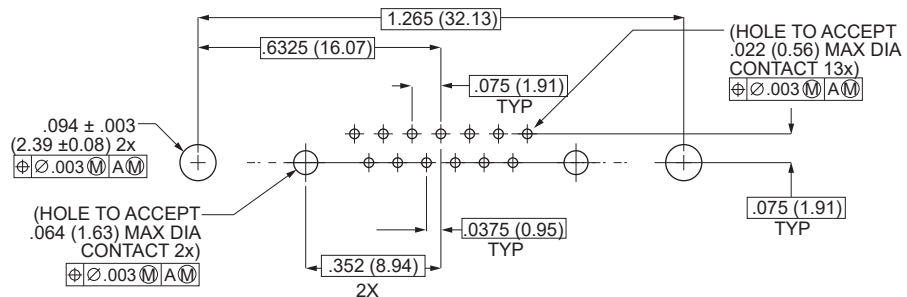
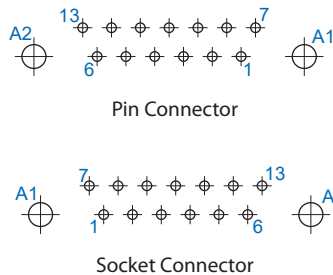

F-23 Arrangement

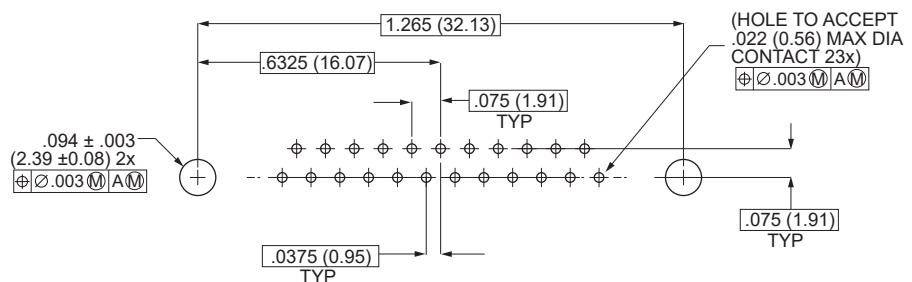
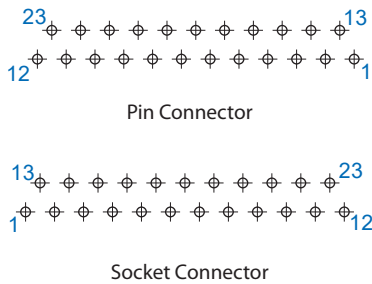

F-5P5 Arrangement

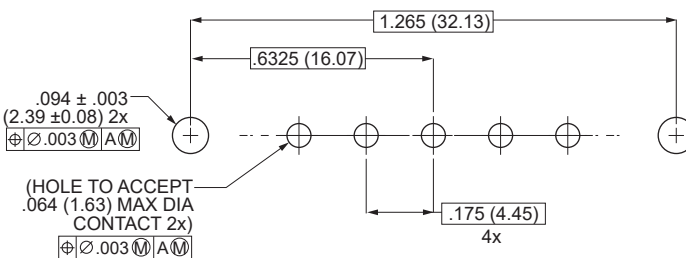
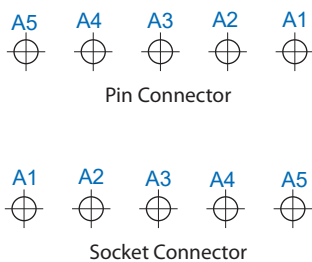

G-13P2 Arrangement

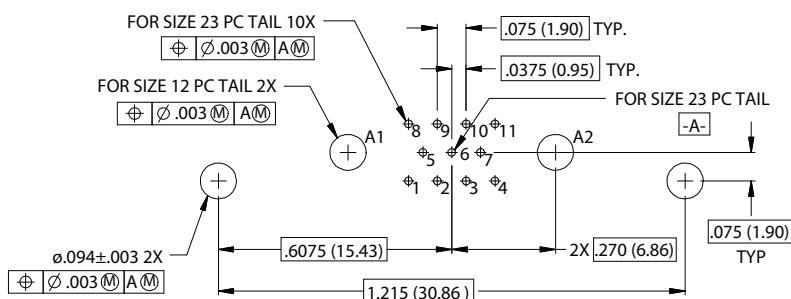
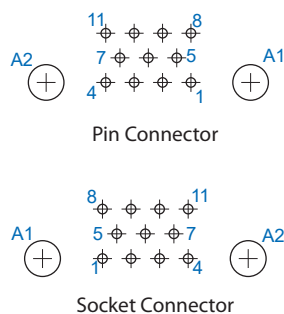

PCB Hole Patterns for Series 791 Connectors

Right Angle PCB Hole Patterns

PCB Hole Patterns for Right Angle Series 79 Connectors

Right angle PCB hole patterns are shown for the *component mounting side* of the circuit board. Connector orientation is shown in the illustration to the right with the connector facing up.

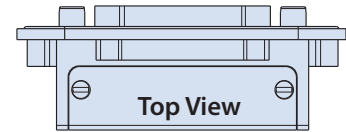

G-21P1 Arrangement

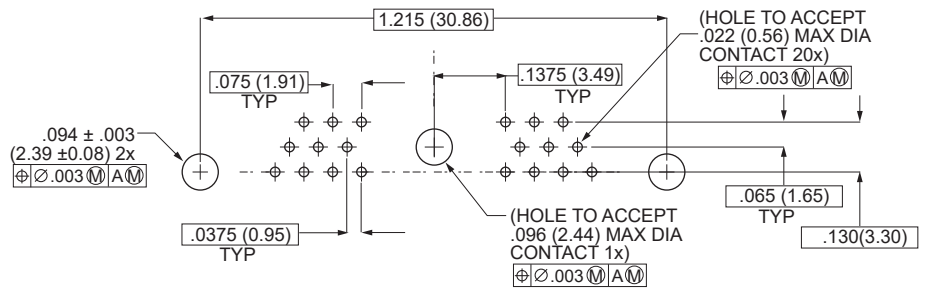
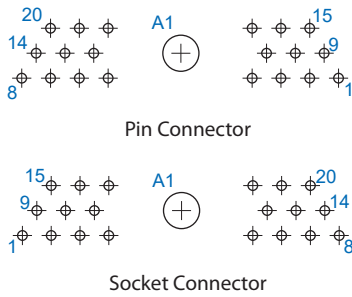

G-33 Arrangement

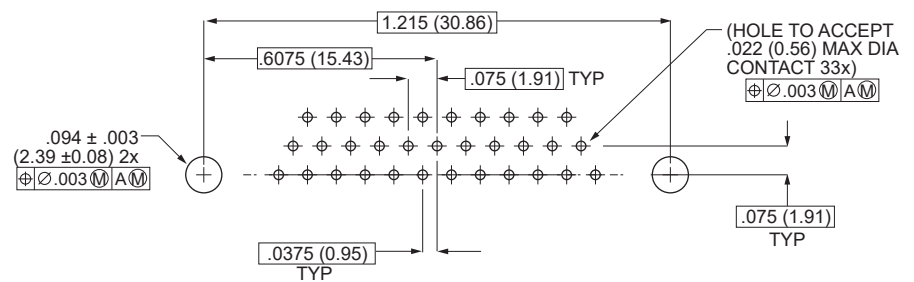
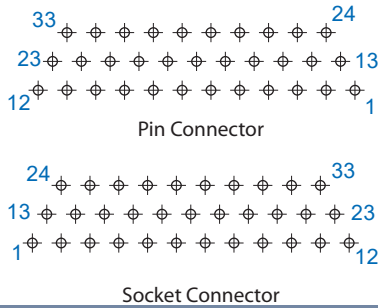

G-3P3 Arrangement

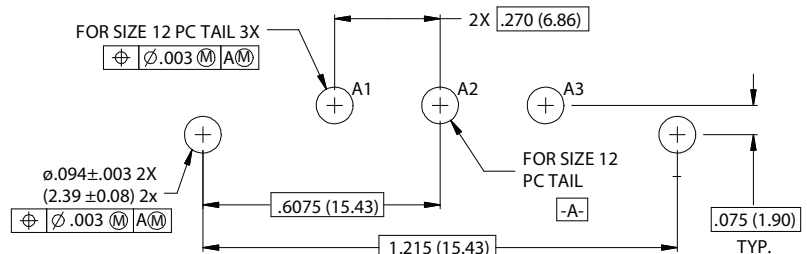
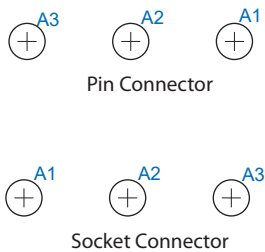

H-10P4 Arrangement

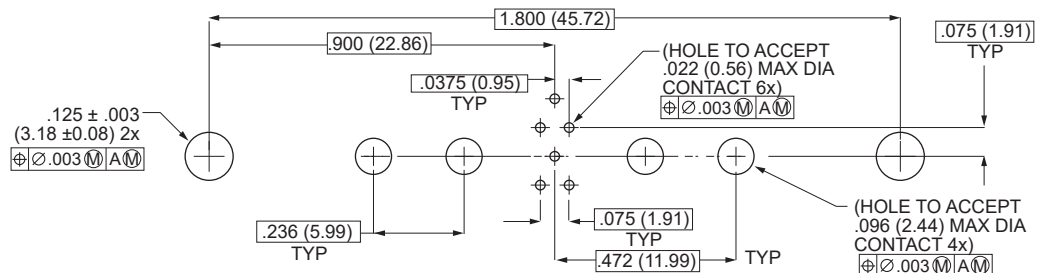
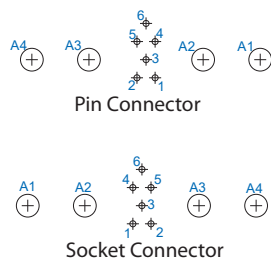

PCB Hole Patterns for Series 791 Connectors

Right Angle PCB Hole Patterns

PCB Hole Patterns for Right Angle Series 79 Connectors

Right angle PCB hole patterns are shown for the *component mounting side* of the circuit board. Connector orientation is shown in the illustration to the right with the connector facing up.



H-29P7 Arrangement

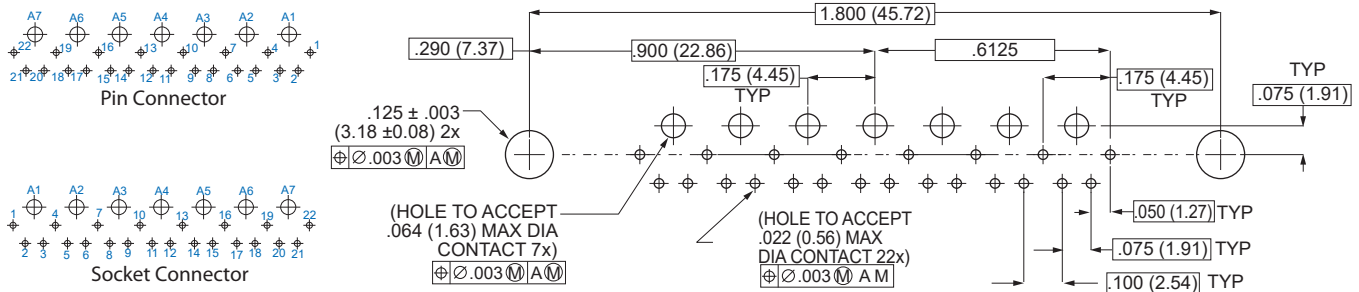

H-36P2 Arrangement

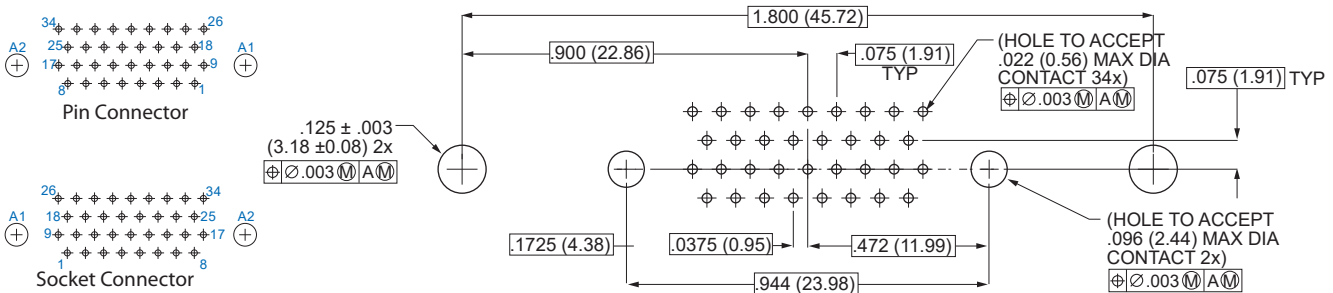

H-54P2 Arrangement

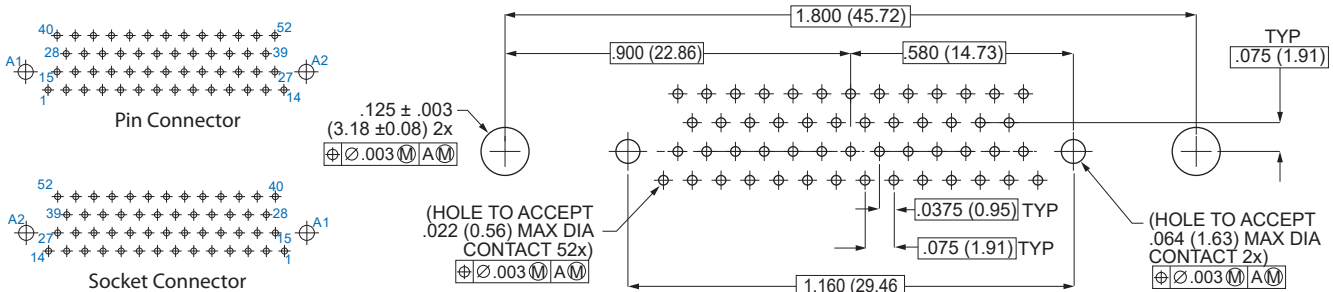

H-5P5 Arrangement

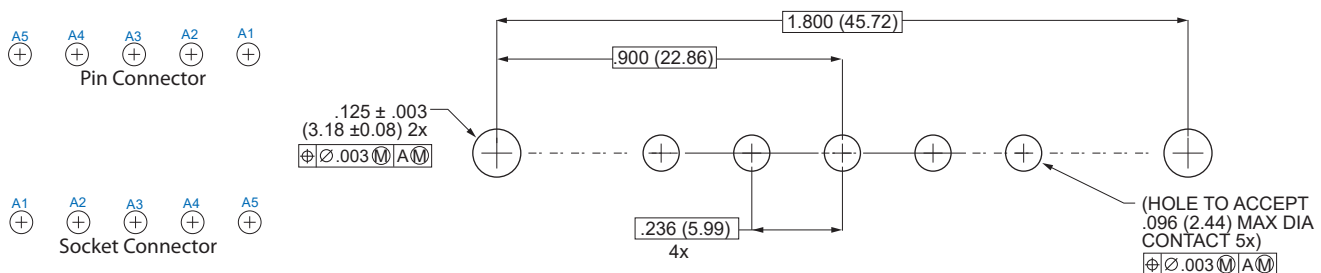

PCB Hole Patterns for Series 791 Connectors

Right Angle PCB Hole Patterns

PCB Hole Patterns for Right Angle Series 79 Connectors

Right angle PCB hole patterns are shown for the *component mounting side* of the circuit board. Connector orientation is shown in the illustration to the right with the connector facing up.

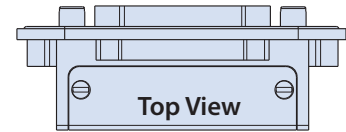

H-66 Arrangement

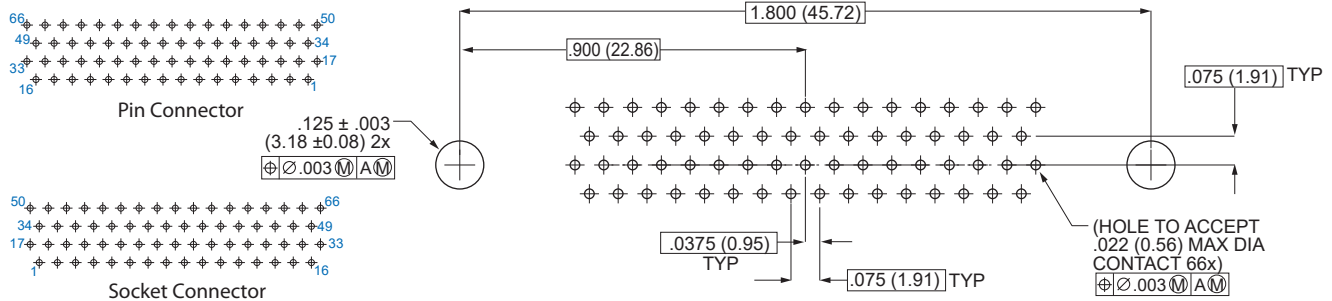

J-17P4 Arrangement

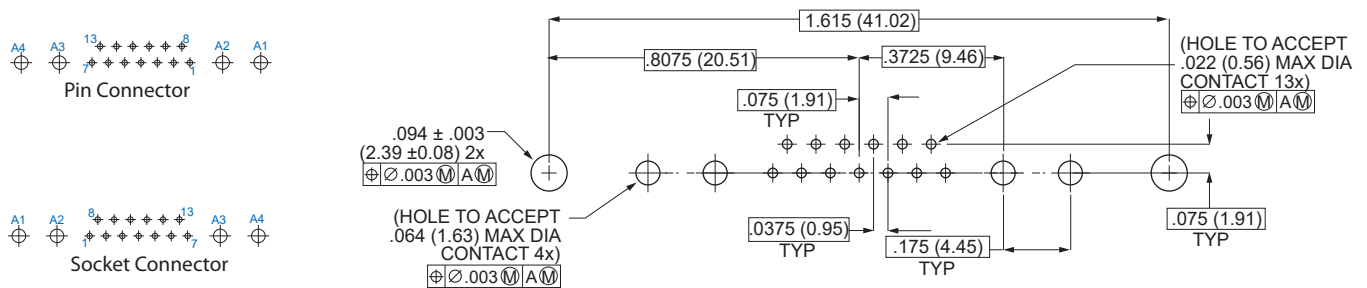

J-25P2 Arrangement

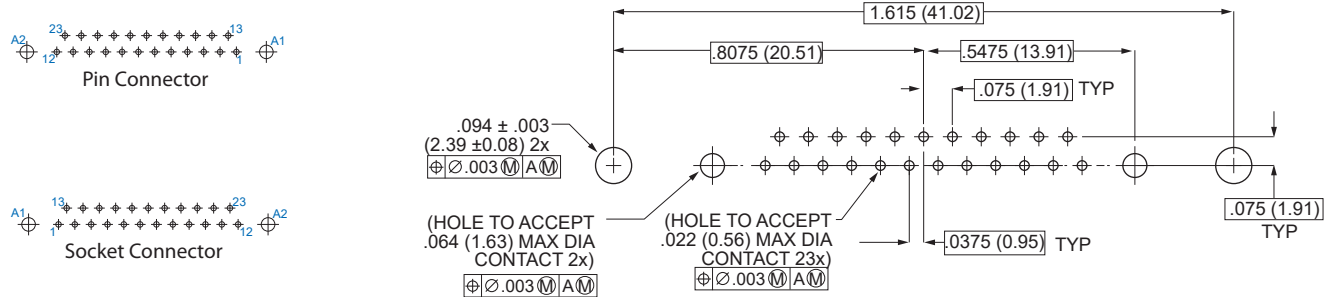

J-33 Arrangement

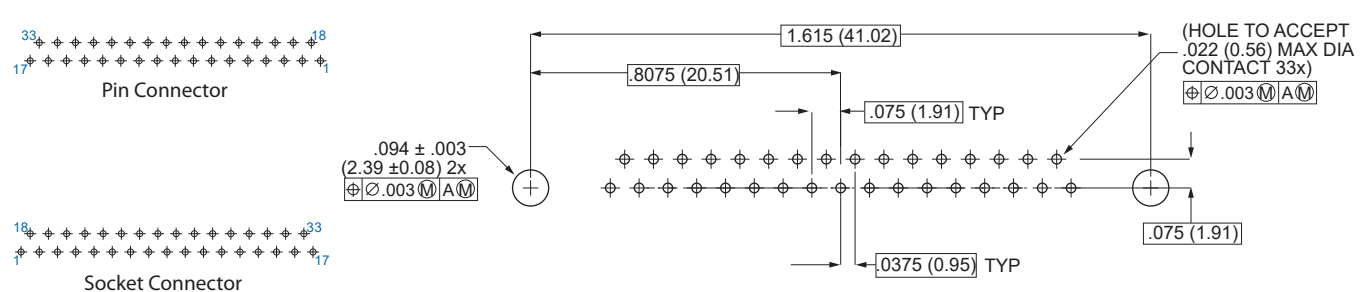

PCB Hole Patterns for Series 791 Connectors

Right Angle PCB Hole Patterns

PCB Hole Patterns for Right Angle Series 79 Connectors

Right angle PCB hole patterns are shown for the *component mounting side* of the circuit board. Connector orientation is shown in the illustration to the right with the connector facing up.

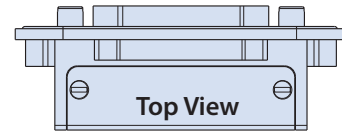

J-7P7 Arrangement

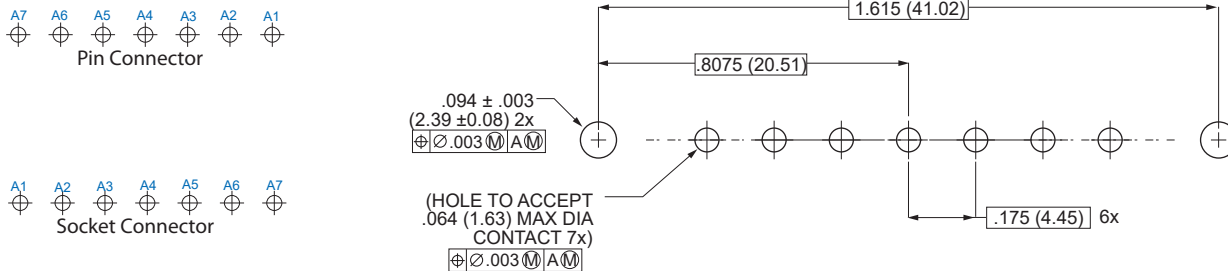

K-27P4 Arrangement

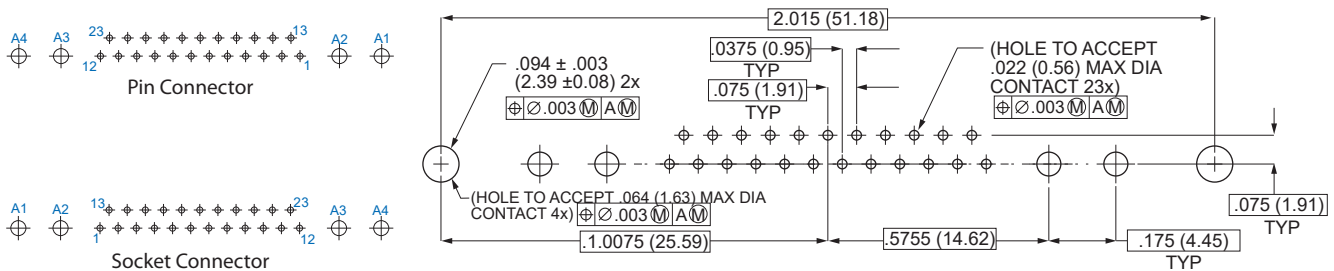

K-35P2 Arrangement

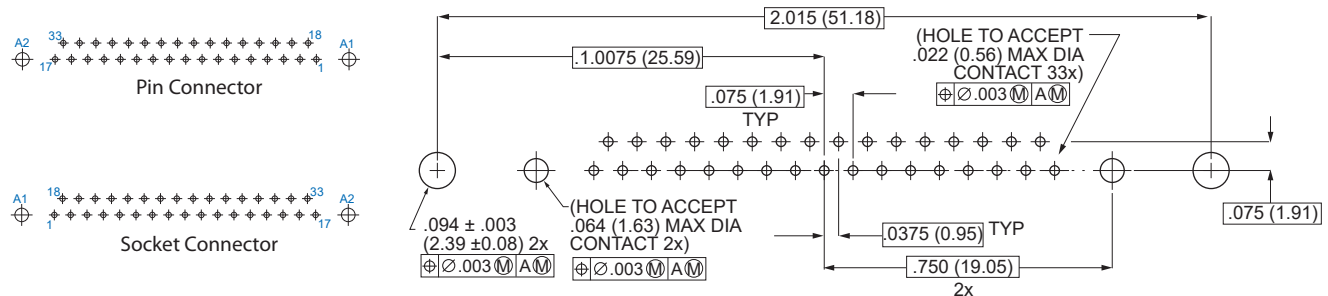

K-43 Arrangement

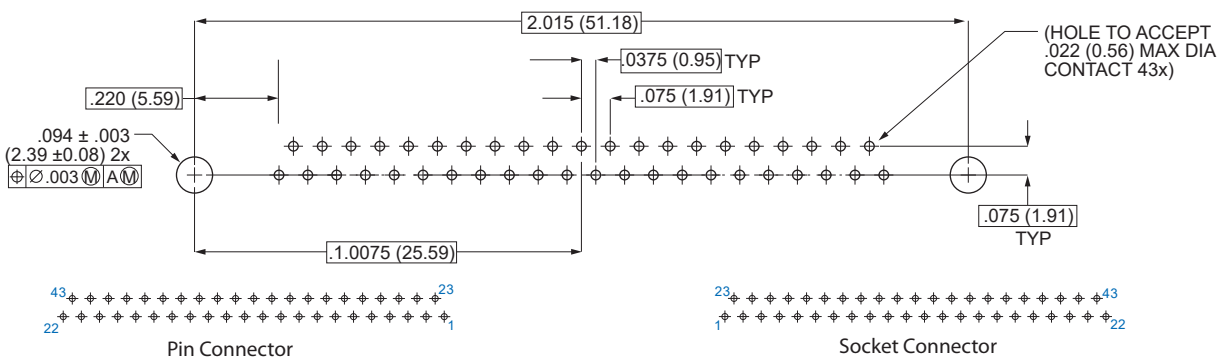

PCB Hole Patterns for Series 791 Connectors

Right Angle PCB Hole Patterns

PCB Hole Patterns for Right Angle Series 79 Connectors

Right angle PCB hole patterns are shown for the *component mounting side* of the circuit board. Connector orientation is shown in the illustration to the right with the connector facing up.

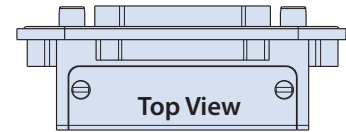

K-9P9 Arrangement

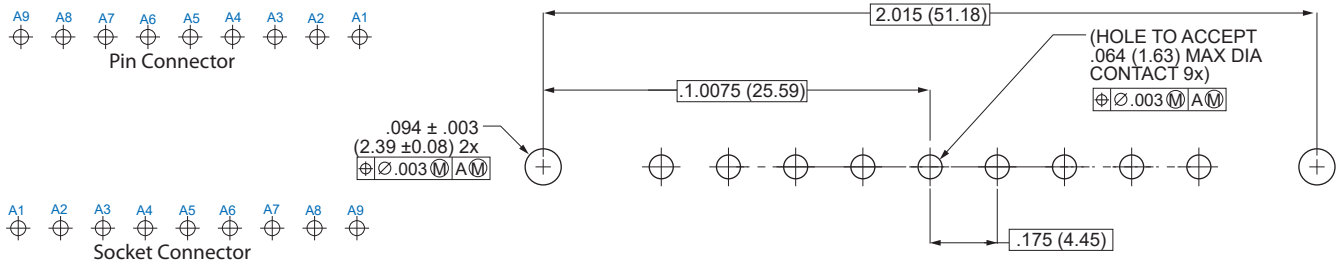

L-6P6 Arrangement

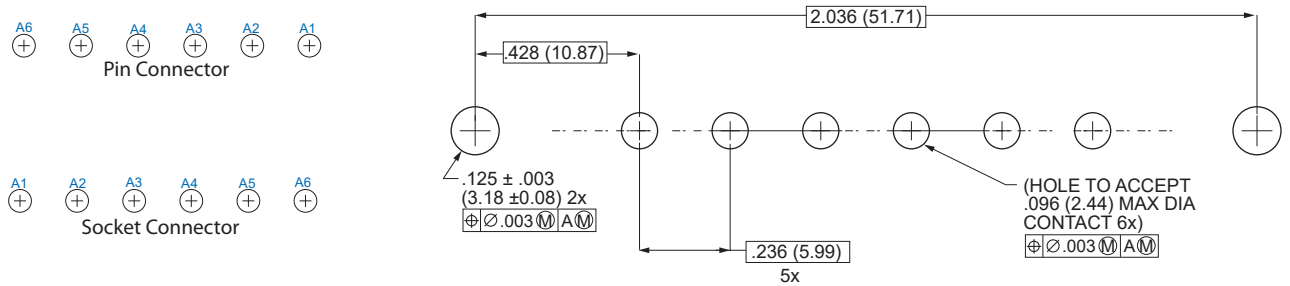

L-78 Arrangement

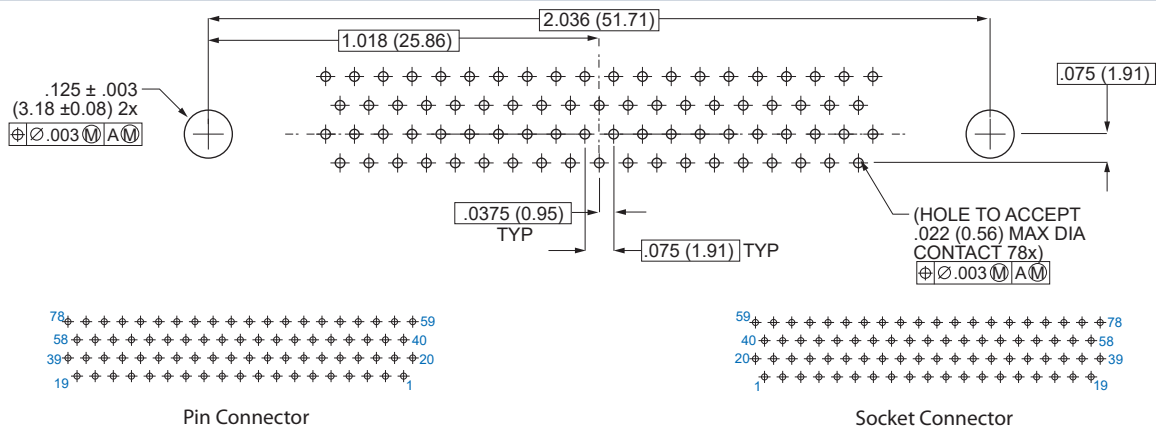

PCB Hole Patterns for Series 791 Connectors

Right Angle PCB Hole Patterns

PCB Hole Patterns for Right Angle Series 79 Connectors

Right angle PCB hole patterns are shown for the *component mounting side* of the circuit board. Connector orientation is shown in the illustration to the right with the connector facing up.

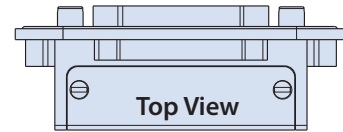

M-102 Arrangement

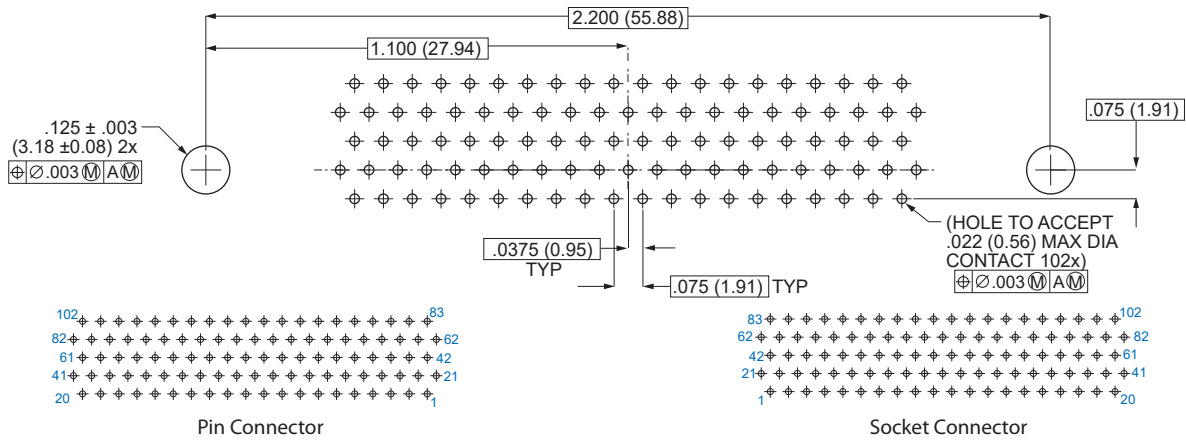

M-17P17 Arrangement

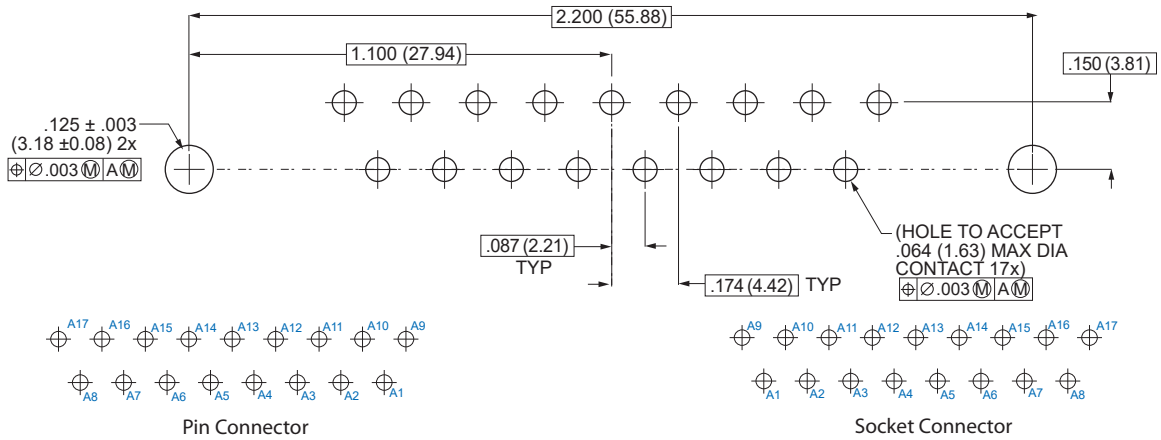

M-4P4 Arrangement

