

Vertical Mount Thru Hole PCB Nano Connectors feature gold alloy TwistPin contacts. These nanominiature connectors offer premium performance and reliability for demanding applications. Available with #0-80 female threads, or with jackscrews for use with flexible circuits.

Pre-Tinned PC Tails are coated with Sn60Pb40 or Sn63Pb37 tin-lead for excellent solderability.

Choose Aluminum, Titanium or Stainless Steel Shells in eight layouts from 5 to 51 contacts. Complies to the requirements of MIL-DTL-32139. These connectors are intermateable with any corresponding Glenair Series 890 single row metal shell nanominiature connector.

How to Order

Sample Part Number	890-007 -25S A2 -BST 1 T
Series	890-006 = Plug, Pin Contacts, Single Row, Vertical Mount PCB 890-007 = Receptacle, Socket Contacts, Single Row, Vertical Mount PCB
Insert Arrangement/ Contact Type	Plugs (890-006): 5P, 9P, 15P, 21P, 25P, 31P, 37P, 51P Receptacles (890-007): 5S, 9S, 15S, 21S, 25S, 31S, 37S, 51S
Shell Material and Finish	A1 = Aluminum Shell, Cadmium Plating T = Titanium Shell, Unplated A2 = Aluminum Shell, Electroless Nickel Plating S = Stainless Steel Shell, Passivated
Termination Type	BST = Board Straight Thru-Hole
PC Tail Length	1 = .110 (2.79) 2 = .172 (4.37) 3 = .140 (3.56)
Hardware	J = Hex Head Jackscrew, #0-80 T = Female Thread, #0-80

Plug (Pin) Connector

Receptacle (Socket) Connector

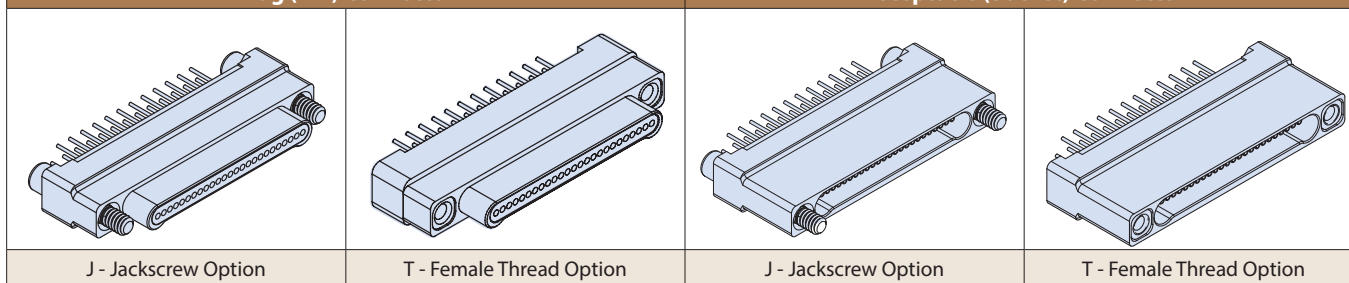

NOTES

- Material and finish:
 - Shell: see part number breakdown
 - Insulator: LCP N/A
 - Contacts: gold alloy/unplated
 - Pre-tinned PC tails: coated with Sn63Pb37 or Sn60Pb40 tin-lead
 - Hardware: stainless steel, passivated
- Inspect and Test IAW MIL-DTL-32139
- Interface dimensions per MIL-DTL-32139/5 and MIL-DTL-32139/6

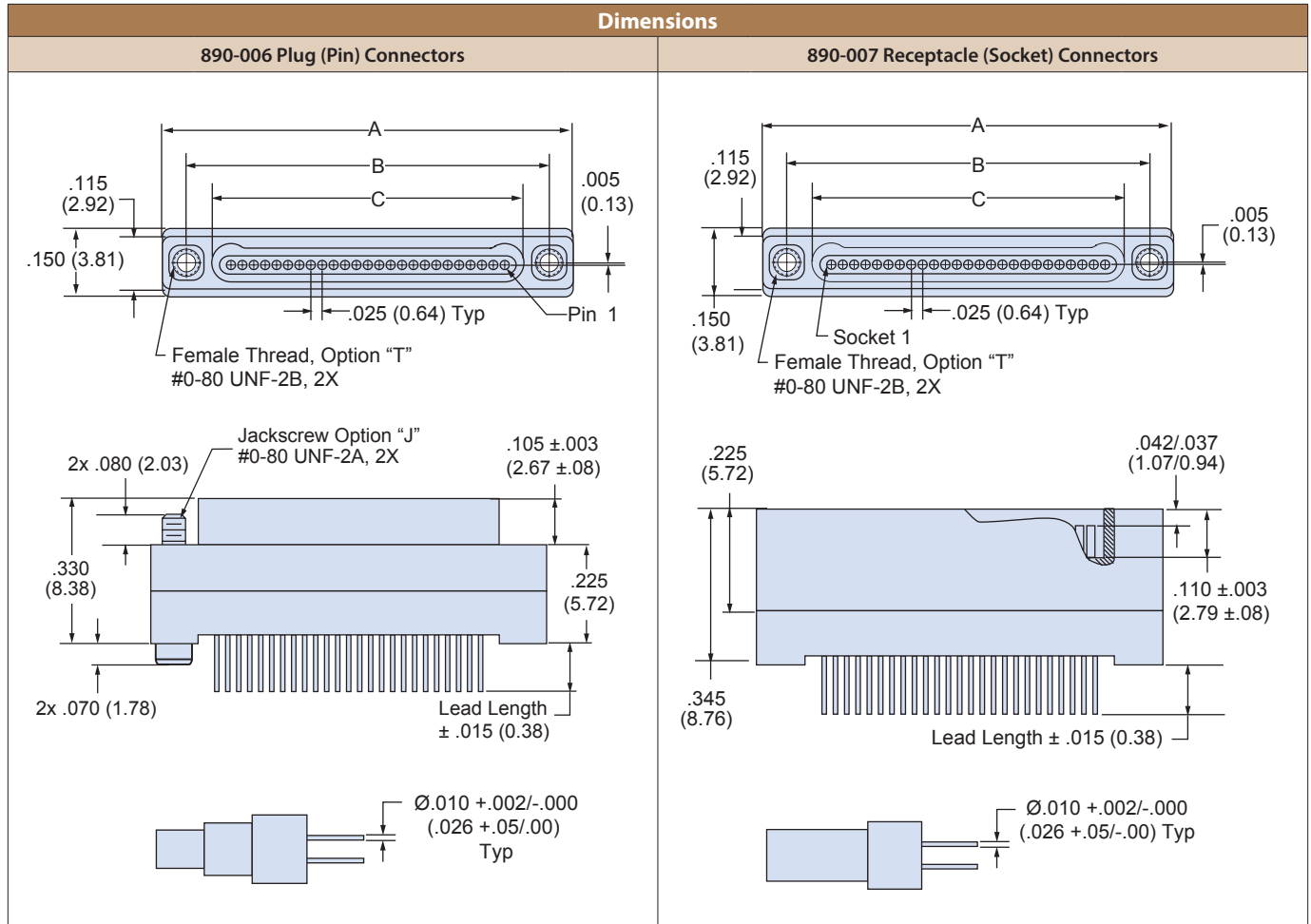

Layout	A		B BSC.		C BSC.	
	In. ± .005	mm. ± 0.13	In.	mm.	In.	mm.
5P	.400	10.16	.295	7.49	.184	4.67
5S	.400	10.16	.295	7.49	.185	4.70
9P	.500	12.70	.395	10.03	.284	7.21
9S	.500	12.70	.395	10.03	.285	7.24
15P	.650	16.51	.545	13.84	.434	11.02
15S	.650	16.51	.545	13.84	.435	11.05
21P	.800	20.32	.695	17.65	.584	14.83
21S	.800	20.32	.695	17.65	.585	14.86
25P	.900	22.86	.795	20.19	.684	17.37
25S	.900	22.86	.795	20.19	.685	17.40
31P	1.050	26.67	.945	24.00	.834	21.18
31S	1.050	26.67	.945	24.00	.835	21.21
37P	1.200	30.48	1.095	27.81	.984	24.99
37S	1.200	30.48	1.095	27.81	.985	25.02
51P	1.550	39.37	1.445	36.70	1.334	33.88
51S	1.550	39.37	1.445	36.70	1.335	33.91

5 Contacts

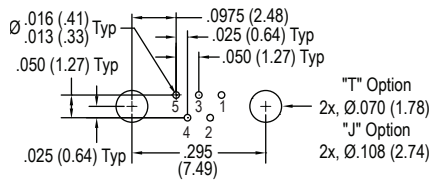

9 Contacts

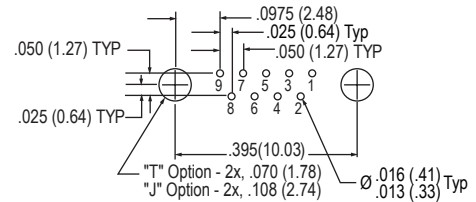

15 Contacts

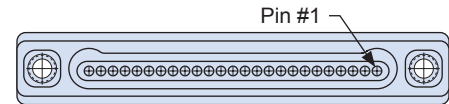
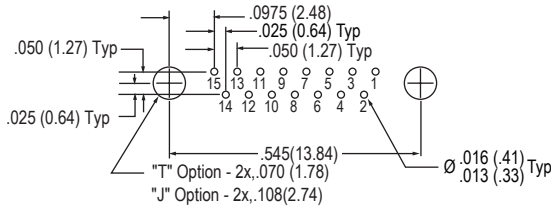

Connector Mating Face

21 Contacts

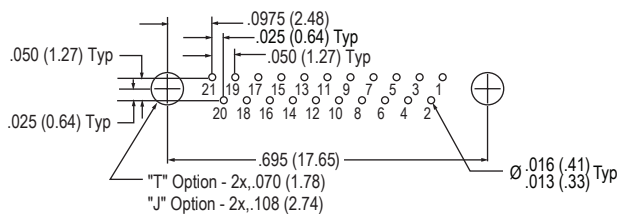

25 Contacts

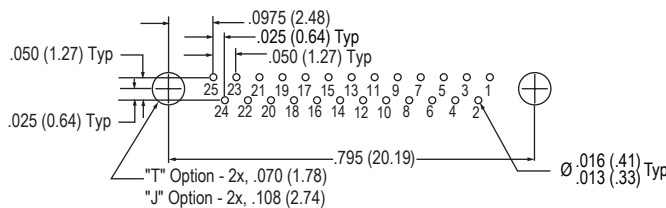

31 Contacts

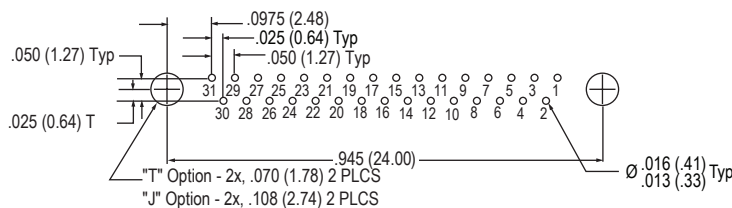

37 Contacts

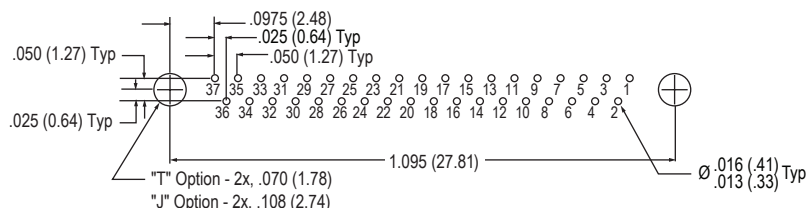

51 Contacts

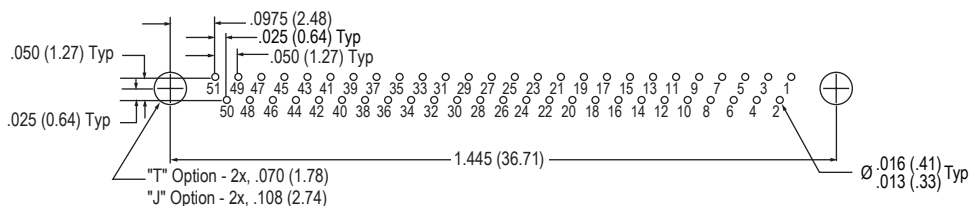

Layouts shown are for connector mounting side of PC Board.

5 Contacts

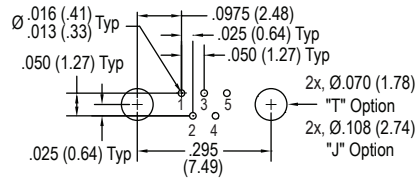

9 Contacts

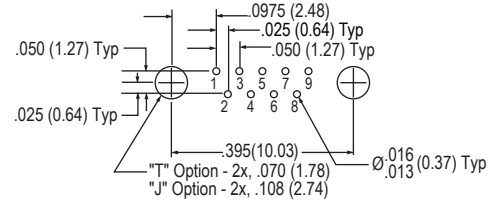

15 Contacts

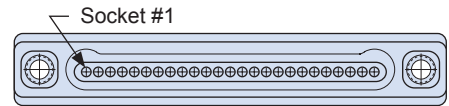
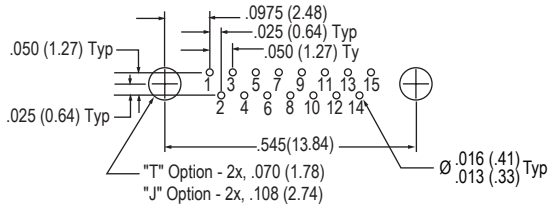

Connector Mating Face

21 Contacts

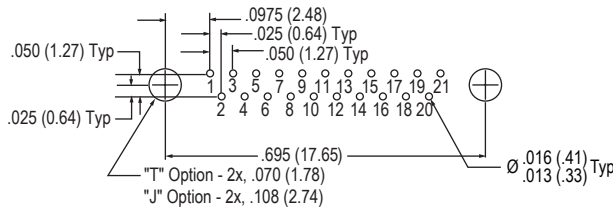

25 Contacts

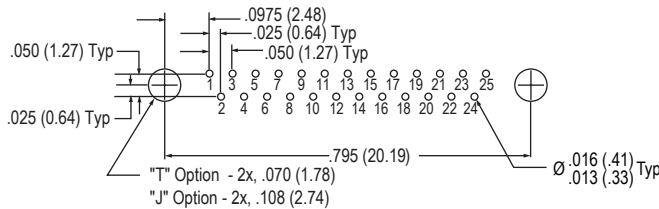

31 Contacts

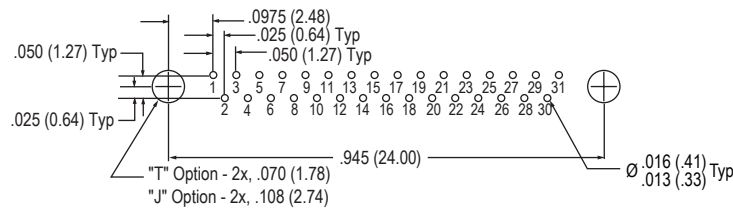

37 Contacts

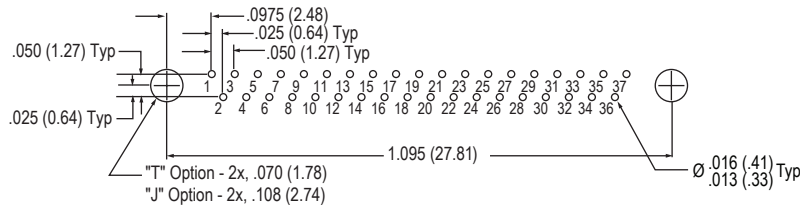

51 Contacts

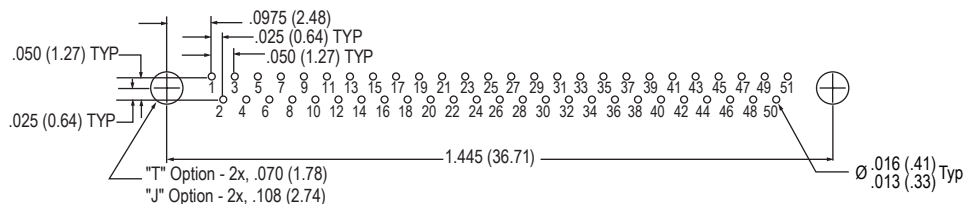

Layouts shown are for connector mounting side of PC Board.