

MATES WITH
892-001,
892-003,
892-005,
893-009,
893-011

Glenair Threaded Coupling Plug Connectors feature gold alloy TwistPin contacts, offering premium performance and reliability for demanding applications. Available with or without backshell. Backshell option available with shrink boot or overmolding.

Choose Aluminum or Stainless Steel Shells in 6 layouts from 4 to 55 contacts. These connectors are intermateable with 892-001, 892-003, 892-005, 893-009, and 893-011 threaded coupling receptacle connectors.

B

How To Order		892	-006	-02	1-7	N	A2	-0	A	7	-12
Sample Part Number											
Series	892 = Nano Circular with Insulated Wire										
Shell Style	006 = Threaded Coupling Plug										
Accessory	01 = No Backshell 02 = With Backshell 03 = Overmolded 04 = Shrink Boot										
Shell Size/Contact Arrangement	1-4 = Shell Size 1 with 4 contacts 3-37 = Shell Size 3 with 37 contacts 1-7 = Shell Size 1 with 7 contacts 4-44 = Shell Size 4 with 44 contacts 2-19 = Shell Size 2 with 19 contacts 4-55 = Shell Size 4 with 55 contacts See Plug Mating Face View and Contact Layout Table										
Polarization	N = Normal A = Alternate										
Shell Material/Finish	A2 = Aluminum/Electroless Nickel S1 = Stainless Steel/Zinc Cobalt (Black) A5 = Aluminum/Gold Over Nickel S2 = Stainless Steel/Passivated										
Wire Gauge	0 = 30 AWG 2 = 32 AWG										
Wire Type	A = Ultra Lightweight XLETFE Insulation, Silver Coated Ultra High Strength Copper. (Not available in #32 AWG) B = Extruded PTFE Insulation, Silver Coated Copper NEMA HP3-ETX (MIL-W-16878/6) C = Cross Linked Modified ETFE Insulation, Silver Coated High Strength Copper. MIL-W-22759/33 (Not available in #32 AWG)										
Wire Color	1 = White 2 = Yellow 7 = 10 Color repeating (Wire type A is striped, types B and C are solid colors)										
Wire Length (Inches)	12 = 12.00 + 1.00 Inches; as required in one inch increments.										

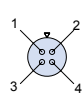
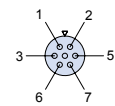
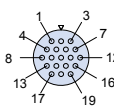
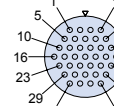
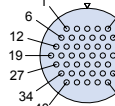
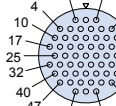
Plug Mating Face View and Contact Layout					
Size 1-4 4 Contacts	Size 1-7 7 Contacts	Size 2-19 19 Contacts	Size 3-37 37 Contacts	Size 4-44 44 Contacts	Size 4-55 55 Contacts
					

B

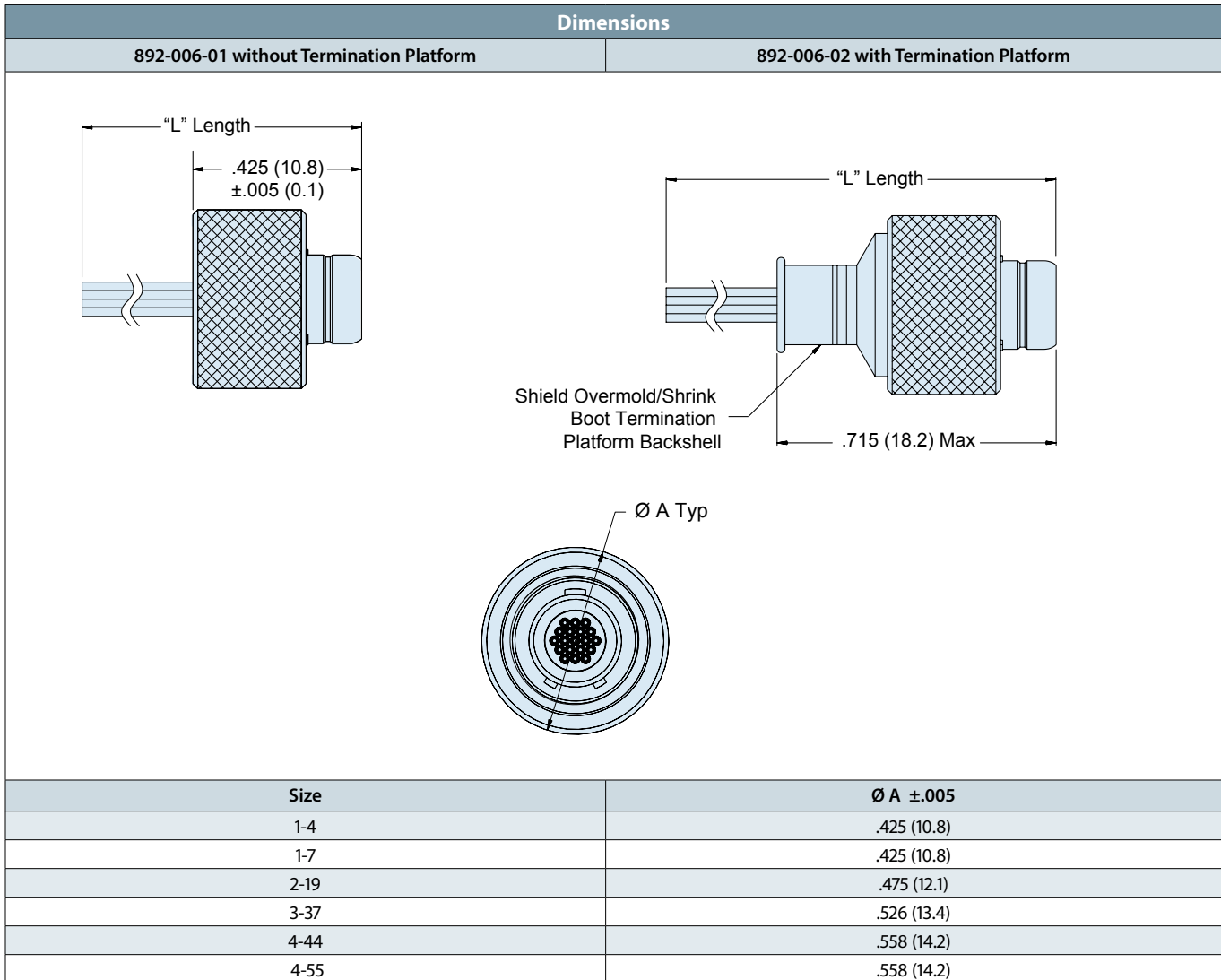

NOTES

- Material/Finish:
 - Shell/coupling ring/backshell - see part number breakdown
 - Insulator - LCP/na
 - Pin contacts - gold alloy
 - Snap ring - stainless steel/passivated

Key Positions			
Size	Polarization	A°	B°
1-4	N	150	210
	A	75	210
1-7	N	95	230
	A	140	275
2-19	N	150	210
	A	75	210
3-37	N	150	210
	A	75	210
4-44	N	150	210
	A	75	210
4-55	N	95	230
	A	140	275

