

Series 66 Protective Covers

for Series 805 Mighty Mouse Connectors

667-262 Receptacle Cover

MM805 Receptacle Cover



667-262 protective cover fits Glenair Series 805 plug connectors. Aluminum or stainless steel, with stainless steel fittings. Fluorosilicone gasket.









PART NUMBER

	667-262	-M	-S	13	02	-5
Base P/N	667-262					
Material/Finish	See Table 1					
Attachment Type	-N No Attachment See Table 2 for Attachment Types					
Shell Size	8 9 10 11 12 13 15 18 19 21 23					
Attachment Ring	Omit for Attachment Types N and SK -00 No Ring See Table 3 for Attachment Ring Codes					
Attachment Length	Omit for Attachment Type N Length in One Inch Increments					

TABLE 1 MATERIAL / FINISH

Aluminum	Stainless Steel
-C Black Anodize	-Z1 Passivate
-M Electroless Nickel	
-NF Olive Drab Cadmium	
-MT Nickel-PTFE	
-ZR Black Zinc-Nickel	
-TZ Tin-Zinc	

TABLE 2 ATTACHMENT TYPE

D	 SST Bead Chain .125 (3.2) diameter, size 6, -65 to +200 °C
F	 Wire Rope, Blue Nylon Jacket 6/6 nylon over stainless steel rope, fair flexibility, good abrasion resistance, -55 to +100 °C
G	 Black Nylon Rope Very flexible, good abrasion and fuel resistance, .094 (2.4) diameter, -55 to +100 °C
H	 Wire Rope, Clear FEP Jacket Clear FEP jacket over SST rope, fair flexibility, good abrasion resistance, .100" diameter, -65 to +200 °C
S	 Sash Chain #8 sash chain, stainless steel. Length tolerance is ± one link. .280 (Z1)
SK	 Nylon Rope with Slip Knot Very flexible, good abrasion and fuel resistance, .094 (2.4) diameter. Length includes .5" (13mm) dia. loop, -55 to +100 °C
T	 SST Wire Rope, No Jacket Good flexibility, good abrasion resistance, .047 (1.2) diameter, passivated, -65 to +200 °C
U	 Wire Rope, Black Polyurethane Stainless steel rope with black polyurethane coating, flexible, excellent abrasion resistance and resistance to fuels, .080" (2mm) diameter, -55 to +125 °C

Shell Size	B Thread	ø C	
		± .015 (0.4) In.	mm.
8	.5000-1P-.3L-TS-2B	.653	16.6
9	.5625-1P-.3L-TS-2B	.715	18.0
10	.6250-1P-.3L-TS-2B	.778	19.7
11	.6875-1P-.3L-TS-2B	.850	21.6
12	.7500-1P-.3L-TS-2B	.903	22.9
13	.8125-1P-.3L-TS-2B	.965	24.5
15	.9375-1P-.3L-TS-2B	1.091	27.7
18	1.1250-1P-.3L-TS-2B	1.278	32.5
19	1.1875-1P-.3L-TS-2B	1.340	34.0
21	1.3125-1P-.3L-TS-2B	1.490	37.8
23	1.4375-1P-.3L-TS-2B	1.600	40.6

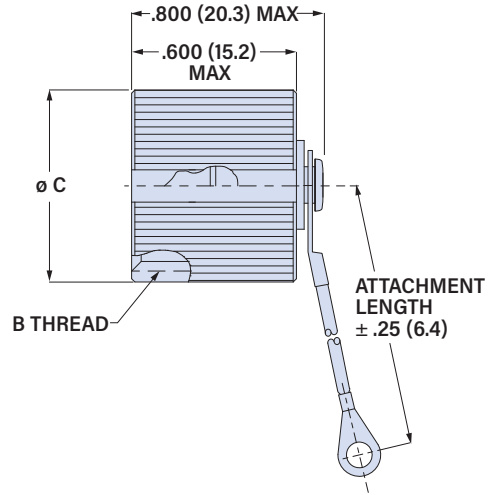



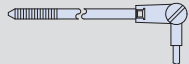

TABLE 3 ATTACHMENT RING

EYELET		SOLID RING		SPLIT RING		CABLE TIE	
							
Code	Eyelet I.D. ± .010 (0.3)	Code	Ring I.D. ± .015 (0.4)	Code	Ring I.D. ± .015 (0.4)	Code	Ring I.D. ± .015 (0.4)
01	.125 (3.2)	32	.265 (6.7)	19	.885 (22.5)	50	.432 (11.0)
02	.145 (3.7)	29	.315 (8.0)	26	.950 (24.1)	52	.492 (12.5)
04	.182 (4.6)	14	.385 (9.8)	28	1.015 (25.8)	54	.648 (16.5)
06	.197 (5.0)	15	.445 (11.3)	20	1.070 (27.2)	56	.757 (19.2)
		33	.510 (13.0)	21	1.135 (28.8)	58	.898 (22.8)
		16	.570 (14.5)	22	1.210 (30.7)	60	1.023 (26.0)
		17	.635 (16.1)	23	1.275 (32.4)	64	1.137 (28.9)
		18	.695 (17.7)	24	.766 (19.46)	68	1.357 (34.5)
		27	.766 (19.5)	30	1.380 (35.1)	Black 6/6 nylon cable tie 1.77 (45.0) max. wire bundle dia.	
		31	.820 (20.8)	25	1.530 (38.9)		