



**ULTRAMINIATURE RECTANGULAR
SERIES 791 CONNECTORS**

**The Scoop-Proof High Performance Environmental Connector for
Signal, Power, RF, and Datalinks**



HIGH PERFORMANCE

Series 791

The Next-Generation Ultraminiature Rectangular Connector for Demanding Aerospace Applications

Sometimes the simplest ideas are the best ideas. The Series 791 is a simple idea. Let's create a brand new class of connector—the ultraminiature rectangular. Let's combine the versatility of the Series 790 Micro-D connector with the rugged features of our popular HiPer-D M24308 type connector. Let's add a unique dual lobe shell and recess the pins to eliminate the possibility of scooping damage. Then let's add high speed datalink capability.

Originally designed for NASA's Orion project, the Series 791, with all its special features, is qualified for manned space flight. The Series 791's small size and blind mate capability make it a perfect choice for 2U and 3U electronics modules. Applications include radars, weapons systems, comms gear, satellites, exoatmospheric vehicles, avionics, power distribution units, instrumentation, and other applications that require a smaller, higher performance interconnect system.

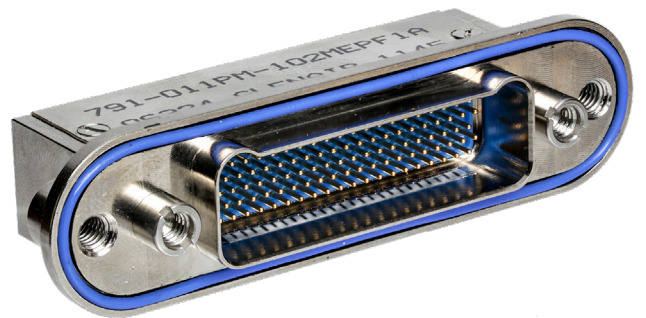

- Next-generation small form factor aerospace-grade rectangular connector
- Scoop-proof
- 37 arrangements, 12 shell sizes for the ultimate in versatility
- Machined aluminum shell
- Environmental
- EMI protection
- Blind mating



Series 791 Connectors

Ruggedized Ultraminiature Rectangular Connectors



Table of Contents

About the Series 791	2
Connector Selection Guide	3
General Information	
Contact Arrangements	4-7
Standard Materials and Product Specification	8-10
Plating Options and RoHS Compliance	11
Series 791 Connectors for Space Flight	12
Keying Option	13
Cable Connectors with Crimp-and-Poke Contacts	
791-003, 791-004 Plug Connectors with Socket Contacts	14-16
791-001, 791-002 Receptacle Connectors with Pin Contacts	17-19
Panel Mount Connectors with Crimp-and-Poke Contacts	
791-020 Plug Connectors with Socket Contacts	20-23
791-019 Receptacle Connectors with Pin Contacts	24-27
Printed Circuit Board Connectors	
791-014 Plug Connectors with Straight Tail PCB Socket Contacts	28-31
791-013 Receptacle Connectors with Straight Tail PCB Pin Contacts	32-35
791-016 Plug Connectors with Right Angle PCB Socket Contacts	36-39
791-032 Receptacle Connectors with Right Angle PCB Pin Contacts	40-43
Panel Mount Printed Circuit Board Connectors	
791-033 Plug Connectors with Straight Tail PCB Socket Contacts	44-47
791-021 Receptacle Connectors with Straight Tail PCB Pin Contacts	48-51
791-012 Plug Connectors with Right Angle PCB Socket Contacts	52-55
791-011 Receptacle Connectors with Right Angle PCB Pin Contacts	56-59
Float Mount Connectors with Crimp-and-Poke Contacts	
791-018 Plug Connectors with Socket Contacts	60-63
791-017 Receptacle Connectors Pin Contacts	64-67
Glass-to-Metal Hermetic Receptacles 791-044	68-71
Filtered Plug 240-791-001, Filtered Receptacle 240-791-003	72-79
Contacts	80-93
Backshells, Protective Covers	94-99
Printed Circuit Board Footprints	100-120

About the Series 791 Ultraminiature Rectangular Connector

Save Size and Weight with Series 791 Connectors

The Next Generation Ultraminiature Rectangular Connector for Demanding Aerospace and Defense Applications

About The Series 791

The Series 791 is an aerospace-grade ultraminiature rectangular connector with EMI protection and environmental sealing. Originally developed for NASA's Orion capsule, The 791 is qualified for manned space flight and is ideal for radars, weapons systems and avionics gear.

The Series 791 is available either with crimp pins or with printed circuit terminals. Machined aluminum alloy shells feature dual lobes for polarization. Contact sizes range from size 8 to size 23 in 37 arrangements. Pin contacts are recessed to prevent scooping damage while mating. Crimp contacts conform to M39029 requirements and are rear release.

An optional ground spring reduces susceptibility to EMI problems. Fluorosilicone face seals and wire grommets prevent moisture and contamination. Panel mount versions are available with an O-ring, or for improved panel bonding, a metal spring.

Board mount versions include straight or right angle terminals. Right angle PCB connectors feature an aluminum cover for added EMI protection.

Hardware options include screwlocks, jackscrews or guide pins for blind mate applications.



M-17P17 with size 16 contacts

- Two to 102 contacts
- Coax, twinax, quadax and Ochto octaxial contacts
- Rugged aluminum shell with dual polarizing lobes



Shell size A – the smallest 791

- Integral band platform for direct attachment of cable braid
- -65 to +150°C
- Panel mount versions with O-ring or EMI spring



Integral backshell connector

- 37 contact arrangements
- Crimp-and-poke or epoxy-sealed board mount versions
- Scoop-proof recessed pins
- Size 23, 16, 12 and 8 contacts

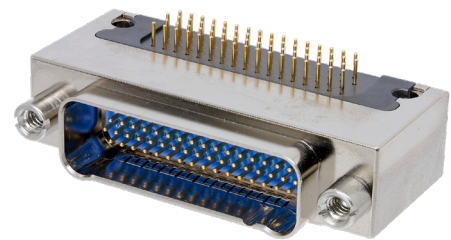

- Straight and right angle printed circuit board mounting
- 12 shell sizes
- Guide pins for blind mate modules



- Contacts meet SAE AS39029 requirements
- Internal ground spring for EMI protection
- Approved for manned space flight

Series 791 Ultraminiature Rectangular Connector Categories

Cable Connectors, Supplied With Customer-Installed Crimp-and-Poke Contacts

Plugs with Female Socket Contacts

Groove for EMI Backshell

Integral EMI Banding Platform

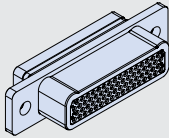

791-003 Page 14

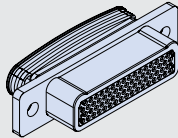

791-004 Page 14

Receptacles with Male Pin Contacts

Groove for EMI Backshell

Integral EMI Banding Platform

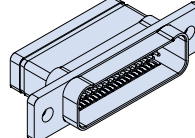

791-001 Page 17

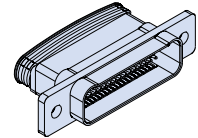

791-002 Page 17

Panel Mount Connectors, Supplied with Customer-Installed Crimp-And-Poke Contacts

Plugs with Female Socket Contacts

Rear Panel Mount with O-ring

Float Mount

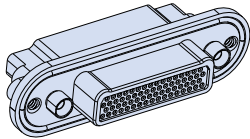

791-020 Page 20

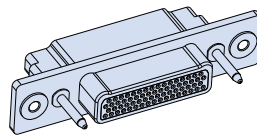

791-018 Page 60

Receptacles with Male Pin Contacts

Rear Panel Mount with O-ring

Float Mount

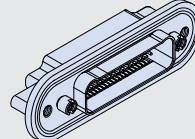

791-019 Page 24

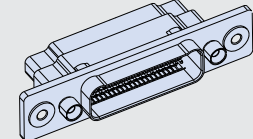

791-017 Page 64

Printed Circuit Board Connectors Supplied with Epoxy-Sealed Non-Removable PCB Terminals

Plugs with Female Socket Contacts

Straight Terminals

Right Angle Terminals

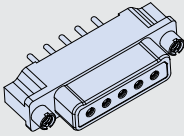

791-014 Page 28

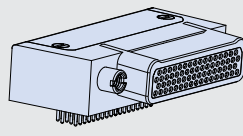

791-016 Page 36

Receptacles with Male Pin Contacts

Straight Terminals

Right Angle Terminals

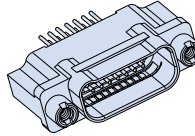

791-013 Page 32

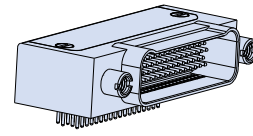

791-032 Page 40

Panel Mount Printed Circuit Board Connectors with Epoxy-Sealed Non-Removable PCB Terminals

Plugs with Female Socket Contacts

Straight Terminals

Right Angle Terminals

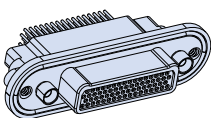

791-033 Page 44

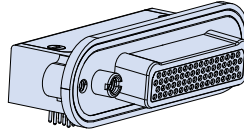

791-012 Page 52

Receptacles with Male Pin Contacts

Straight Terminals

Right Angle Terminals

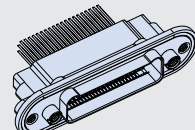

791-021 Page 48

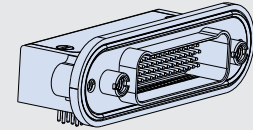

791-011 Page 56

Panel Mount Hermetic, Glass Sealed Connectors

Receptacle with Non-Removable Male Pin Contacts

Straight Terminals

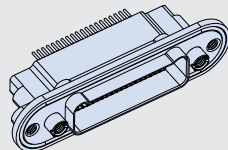

791-044 Page 68

Panel Mount Filter Connectors

Receptacles with Non-Removable Male Pin Contacts

Solder Cup Pin Contacts

Solder Cup Socket Contacts

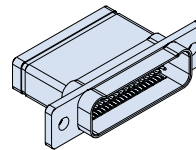

240-791-001 Page 72

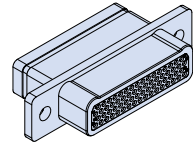

240-791-011 Page 76

Contact Arrangements

Series 791 Contact Arrangements

Series 791 "Combo" Contact Arrangements

can be ordered two

ways:

1. With a full set of contacts.
2. With #23 contacts but without #16, #12 or #8 contacts.

The Arrangement Number determines whether the size 16, 12 or 8 contacts are supplied. The first letter represents the shell size. The number following the shell size represents the total number of contacts. If the insert arrangement is a mixed layout with signal contacts and coaxial/power contacts, the letter "W" specifies the connector to be furnished with signal contacts only (size 16, 12 and 8 contacts purchased separately), and the letter "P" specifies the connector to be furnished with both signal and power contacts.

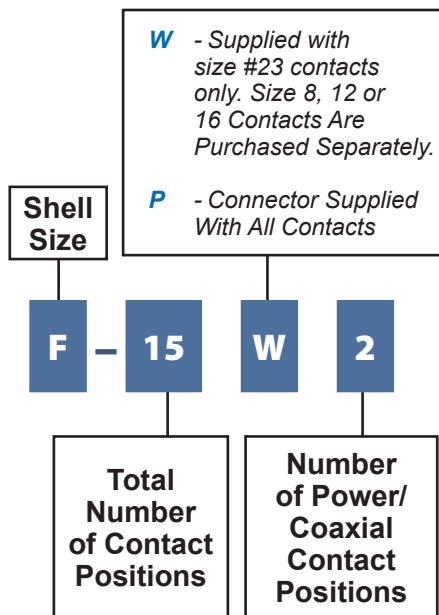

Series 791 Contact Arrangements						
Shell Size	Arrangement Number		Quantity of Contacts			
	Full Complement of Contacts	#8, #12 or #16 Contacts Purchased Separately	#23	#16	#12	#8
A	A-5		5			
B	B-2P2	B-2W2		2		
	B-9		9			
C	C-13		13			
D	D-15		15			
	D-3P3	D-3W3		3		
	D-7P2	D-7W2	5	2		
E	E-11P2	E-11W2	9	2		
	E-19		19			
	E-7P3	E-7W3	4	3		
F	F-14P3	F-14W3	11	3		
	F-15P2	F-15W2	13	2		
	F-23		23			
	F-5P5	F-5W5		5		
G	G-33		33			
	G-13P2	G-13W2	11		2	
	G-21P1	G-21W1	20		1	
	G-3P3	G-3W3			3	
H	H-10P4	H-10W4	6		4	
	H-29P7	H-29W7	22	7		
	H-36P2	H-36W2	34		2	
	H-54P2	H-54W2	52	2		
	H-5P5	H-5W5			5	
J	H-66		66			
	J-17P4	J-17W4	13	4		
	J-25P2	J-25W2	23	2		
	J-33		33			
	J-7P7	J-7W7		7		
K	K-27P4	K-27W4	23	4		
	K-35P2	K-35W2	33	2		
	K-43		43			
	K-9P9	K-9W9		9		
L	L-6P6	L-6W6			6	
	L-78		78			
M	M-17P17	M-17W17		17		
	M-102		102			
	M-4P4	M-4W4 M-4G4				4

Contact Arrangements

Mating face of pin connector (receptacle). Socket (plug) cavity locations are reversed.

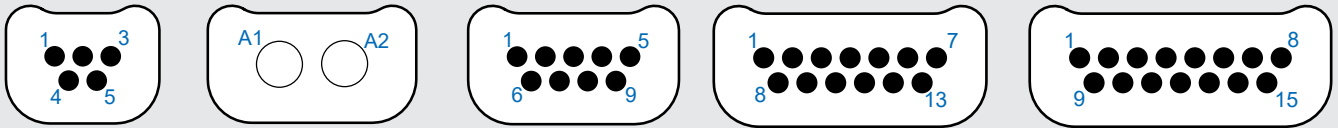

A-5
5 #23

B-2P2
2 #16

B-9
9 #23

C-13
13 #23

D-15
15 #23

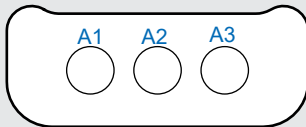

D-3P3
3 #16

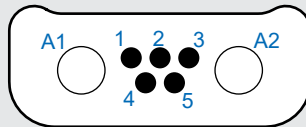

D-7P2
5 #23, 2 #16

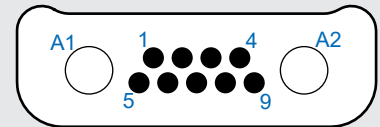

E-11P2
9 #23, 2 #16

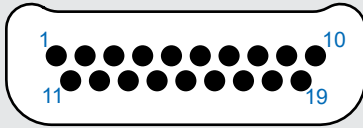

E-19
19 #23

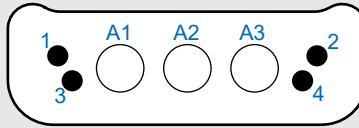

E-7P3
4 #23, 3 #16

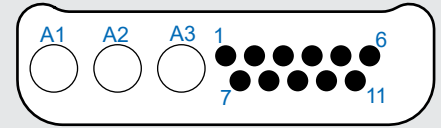

F-14P3
11 #23, 3 #16

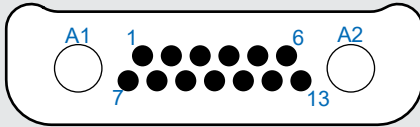

F-15P2
13 #23, 2 #16

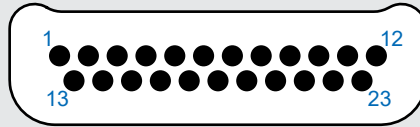

F-23
23 #23

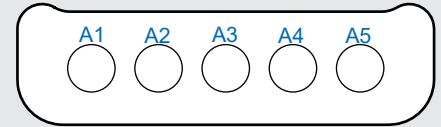

F-5P5
5 #16

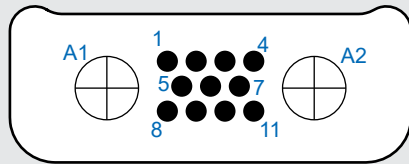

G-13P2
11 #23, 2 #12

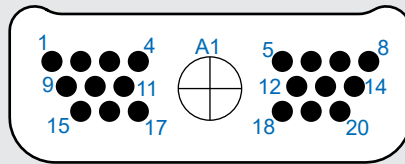

G-21P1
20- #23, 1 #12

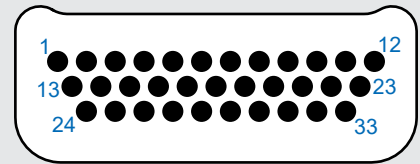

G-33
33 #23

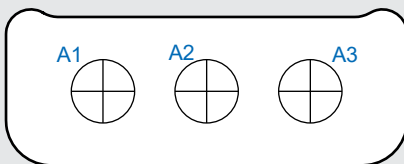

G-3P3
3 #12

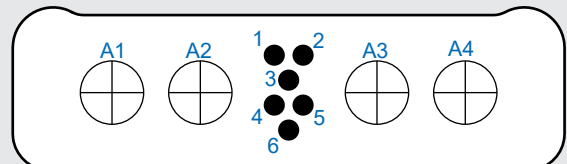

H-10P4
6 #23, 4 #12

Contact Arrangements

Mating face of pin connector (receptacle). Socket (plug) cavity locations are reversed.

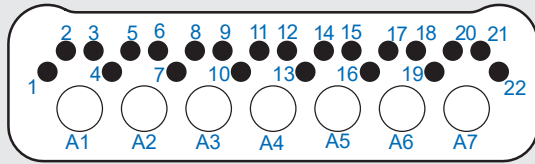

H-29P7
22 #23, 7 #16

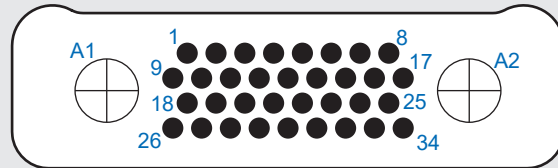

H-36P2
34 #23, 2 #12

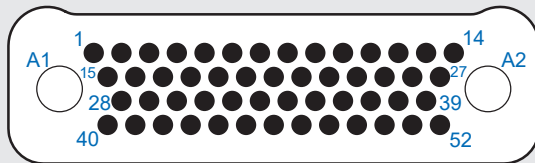

H-54P2
52 #23, 2 #16

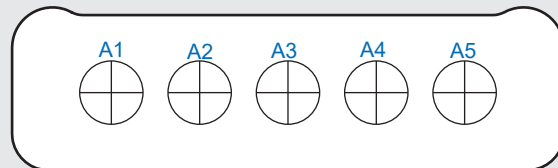

H-5P5
5 #12

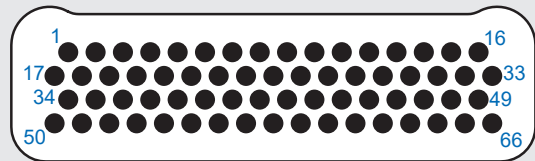

H-66
66 #23

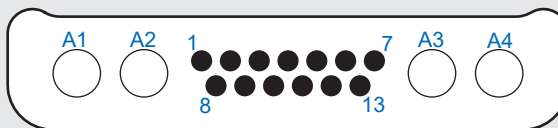

J-17P4
13 #23, 4 #16

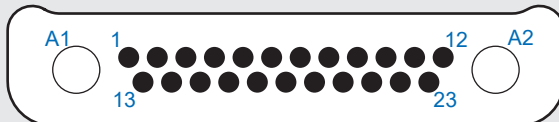

J-25P2
23 #23, 2 #16

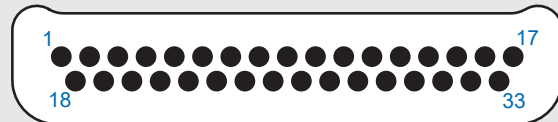

J-33
33 #23

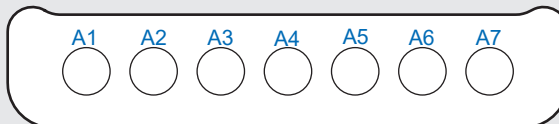

J-7P7
7 #16

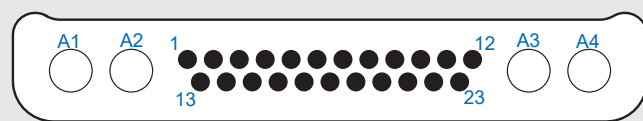

K-27P4
23 #23, 4 #16



K-35P2
33 #23, 2 #16



K-43
43 #23

Contact Arrangements

Mating face of pin connector (receptacle). Socket (plug) cavity locations are reversed.

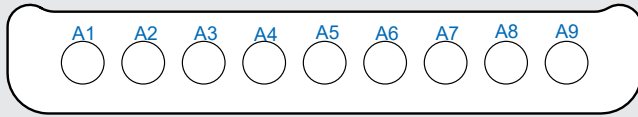

K-9P9
9 #16

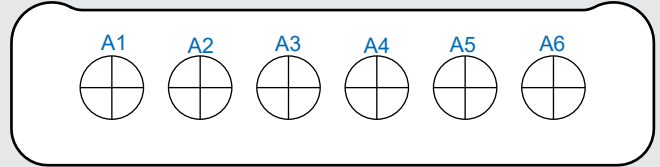

L-6P6
6 #12

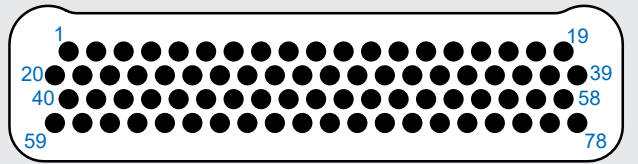

L-78
78 #23

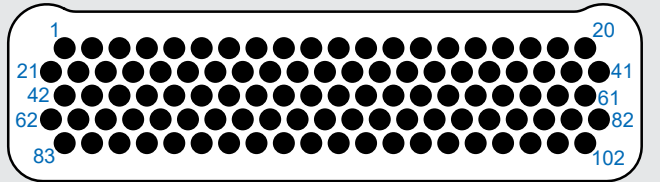

M-102
102 #23

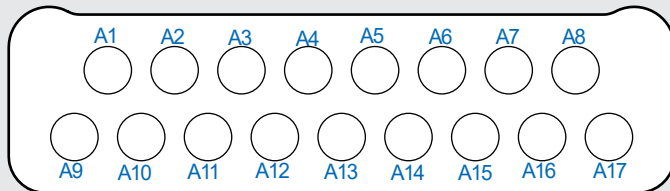

M-17P17
17 #16

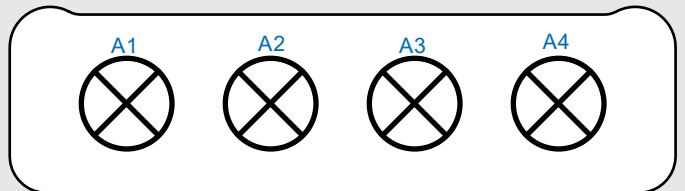

M-4P4
4 #8

Series 791 Standard Materials, Product Specification

Series 791 Standard Materials

DESCRIPTION	MATERIAL	FINISH
Contacts	Copper alloy	Gold plated 50 microinches minimum over nickel underplate.
Socket Contact Hood	Stainless steel	Passivated
Shell	Aluminum alloy 6061	Code M: electroless nickel per ASTM B-733 Code MT: Nickel PTFE per SAE AMS2454 Code ZR: Black zinc-nickel per ASTM B841
Insulators, PCB tray	High grade rigid dielectric	None
Interfacial seal and grommet	Fluorosilicone blend elastomer	None
O-ring, non-conductive	Fluorosilicone blend elastomer	None
O-ring, conductive	Silver-plated aluminum-filled fluorosilicone	None
EMI spring	Beryllium Copper	Nickel
Panel Spring	Beryllium Copper	Gold
Contact retention clip, insert assembly retention clip	Beryllium copper	None
Jackscrews, jackposts, washers, threaded inserts, nuts	300 series stainless steel	passivated
EMI Cover, right angle PCB	Aluminum	See shell finish options

Series 791 Product Specification (ref: 799-008)

DESCRIPTION	REQUIREMENT	PROCEDURE																														
Contact resistance	SAE AS39029 Table V <table border="1" style="margin-left: 20px;"> <thead> <tr> <th>Max. Wire Size (AWG)</th> <th>Test Current (A)</th> <th>Maximum Voltage Drop (mV)</th> </tr> </thead> <tbody> <tr><td>8</td><td>46</td><td>26</td></tr> <tr><td>12</td><td>23</td><td>42</td></tr> <tr><td>14</td><td>17</td><td>40</td></tr> <tr><td>16</td><td>13</td><td>49</td></tr> <tr><td>20</td><td>7.5</td><td>55</td></tr> <tr><td>22</td><td>5</td><td>73</td></tr> <tr><td>24</td><td>3</td><td>45</td></tr> <tr><td>26</td><td>2</td><td>52</td></tr> <tr><td>28</td><td>1.5</td><td>54</td></tr> </tbody> </table>	Max. Wire Size (AWG)	Test Current (A)	Maximum Voltage Drop (mV)	8	46	26	12	23	42	14	17	40	16	13	49	20	7.5	55	22	5	73	24	3	45	26	2	52	28	1.5	54	EIA-364-06 Silver-coated copper wire, 25°C
Max. Wire Size (AWG)	Test Current (A)	Maximum Voltage Drop (mV)																														
8	46	26																														
12	23	42																														
14	17	40																														
16	13	49																														
20	7.5	55																														
22	5	73																														
24	3	45																														
26	2	52																														
28	1.5	54																														
Low level contact resistance	<table border="1" style="margin-left: 20px;"> <thead> <tr> <th>Wire Size</th> <th>Milliohms Max</th> </tr> </thead> <tbody> <tr><td>16</td><td>5</td></tr> <tr><td>20</td><td>9</td></tr> <tr><td>22</td><td>15</td></tr> <tr><td>24</td><td>20</td></tr> <tr><td>26</td><td>31</td></tr> <tr><td>28</td><td>50</td></tr> </tbody> </table>	Wire Size	Milliohms Max	16	5	20	9	22	15	24	20	26	31	28	50	EIA-364-23																
Wire Size	Milliohms Max																															
16	5																															
20	9																															
22	15																															
24	20																															
26	31																															
28	50																															
Insulation resistance	5000 megohms minimum	EIA-364-21																														
Dielectric withstanding voltage	No breakdown or flashover	EIA-364-20 #23 contact 750 volts #8, 12 and #16 contacts 1800 volts																														



Series 791 Connectors

Ruggedized Ultraminiature Rectangular Connectors



Series 791 Product Specification

DESCRIPTION	REQUIREMENT	PROCEDURE												
Current carrying capacity	<table border="1"> <thead> <tr> <th>Contact Size</th> <th>Max Current</th> </tr> </thead> <tbody> <tr> <td>8</td> <td>46 A</td> </tr> <tr> <td>12</td> <td>23 A</td> </tr> <tr> <td>16</td> <td>13 A</td> </tr> <tr> <td>23</td> <td>5 A</td> </tr> </tbody> </table>	Contact Size	Max Current	8	46 A	12	23 A	16	13 A	23	5 A	EIA-364-70 Method 1		
Contact Size	Max Current													
8	46 A													
12	23 A													
16	13 A													
23	5 A													
Shell-to-shell resistance (with ground spring)	2.5 millivolt maximum	EIA-364-83												
Shielding effectiveness	<table border="1"> <thead> <tr> <th>Frequency</th> <th>Attenuation dB</th> </tr> </thead> <tbody> <tr> <td>100</td> <td>75</td> </tr> <tr> <td>1000</td> <td>50</td> </tr> <tr> <td>3000</td> <td>44</td> </tr> <tr> <td>6000</td> <td>38</td> </tr> <tr> <td>10000</td> <td>35</td> </tr> </tbody> </table>	Frequency	Attenuation dB	100	75	1000	50	3000	44	6000	38	10000	35	EIA-364-66
Frequency	Attenuation dB													
100	75													
1000	50													
3000	44													
6000	38													
10000	35													
Ingress protection	IP67 rating	IEC-60529												
Vibration, sine	No discontinuity of greater than 1 microsecond, no cracking, breaking or loosening of parts, plug shall not become disengaged from receptacle.	EIA-364-28 Test Condition IV 100 milliamp test current 10- 2,000 Hz 20 g, 196 m/s ²												
Vibration, random	No discontinuity of greater than 1 microsecond, no cracking, breaking or loosening of parts, plug shall not become disengaged from receptacle.	364-28 Test Condition V Letter E 100 milliamp test current 50- 2,000 Hz 43.92 g rms												
Mechanical shock	No discontinuity of greater than 1 microsecond, no cracking, breaking or loosening of parts, plug shall not become disengaged from receptacle.	EIA-364-27 Condition D 3 shocks X 3 axes X 2 directions = 18 shocks 2941 m/s ² (300 g's), 3 ms, half-sine												
Thermal shock	No mechanical damage or loosening of parts. Following thermal shock, connector shall meet contact resistance, DWV, insulation resistance and shell-to-shell resistance requirements	EIA-364-32 Test Condition IV 5 cycles consisting of -65° C 30 minutes, +25° C 5 minutes max., +150° C 30 minutes, +25° C 5 minutes max.												
Humidity, Cyclic	No deterioration which will adversely affect the connector. 100 megohms minimum insulation resistance during the final cycle. Following the recovery period, connectors shall meet contact resistance, shell-to-shell resistance and DWV requirements.	EIA-364-31 Condition B Method IV 80-98% RH 10 cycles (10 days) +25° C to +65° C Step 7b vibration deleted. 24 hour recovery period.												
Altitude – Low Temperature	5000 megohms minimum insulation resistance.	EIA-364-105 -65° C 100,000 feet (11 mbar) Wired, mated pairs												

Series 791 Product Specification

DESCRIPTION	REQUIREMENT	PROCEDURE										
Mechanical Durability, at Ambient Temperature	No deterioration which will adversely affect the connector after 500 cycles of mating and unmating. Connectors shall meet contact resistance, insulation resistance, shell-to-shell resistance, DWV, and mating and unmating force.	EIA-364-09										
Insert retention	50 PSI	EIA-364-35										
Corrosion (Salt Mist)	No exposure of base metal. Connectors shall meet DWV and contact resistance requirements following the test.	EIA-364-26, 5% salt solution, 35° unmated connectors Code M: electroless nickel 48 hours Code MT: nickel PTFE 500 hours Code ZR: black zinc nickel 500 hours										
Solderability, PC Tail Contacts	95% solder coverage. Smooth, bright and even finish.	EIA-364-52 Category 3 8 hours steam aging prior to test 245° C 4-5 sec. dwell 10X magnification										
Resistance To Soldering Heat, PC tail connectors	No damage to connector. Connectors shall meet insulation resistance and waterproof sealing requirements.	EIA-364-56 260° C, 10 seconds										
Impact, Cable Connectors	No impairment of function. Connector shall meet contact resistance, insulation resistance and waterproof sealing.	EIA-364-42 1 meter 8 drops										
Fluid Immersion	No damage from immersion in various fuels and oils. Connector shall meet mating/unmating force and dielectric withstanding voltage.	EIA-364-10										
Altitude Immersion	No evidence of moisture on connector interface or contacts. Connector shall meet dielectric withstanding voltage.	EIA-364-03 30,000 feet simulated altitude										
Contact retention	<table border="1"> <thead> <tr> <th>Contact Size</th> <th>Min Pounds</th> </tr> </thead> <tbody> <tr> <td>23</td> <td>6</td> </tr> <tr> <td>16</td> <td>25</td> </tr> <tr> <td>12</td> <td>25</td> </tr> <tr> <td>8</td> <td>25</td> </tr> </tbody> </table>	Contact Size	Min Pounds	23	6	16	25	12	25	8	25	EIA-364-29
Contact Size	Min Pounds											
23	6											
16	25											
12	25											
8	25											
Contact separation force	<table border="1"> <thead> <tr> <th>Contact Size</th> <th>Min Ounces</th> </tr> </thead> <tbody> <tr> <td>23</td> <td>0.5</td> </tr> <tr> <td>16</td> <td>2.0</td> </tr> <tr> <td>12</td> <td>3.0</td> </tr> <tr> <td>8</td> <td>5.0</td> </tr> </tbody> </table>	Contact Size	Min Ounces	23	0.5	16	2.0	12	3.0	8	5.0	SAE AS39029 Table 9
Contact Size	Min Ounces											
23	0.5											
16	2.0											
12	3.0											
8	5.0											
Magnetic permeability	2 μ maximum	EIA-364-54										
Thermal vacuum outgassing	Connectors, following special outgassing processing, shall meet < 1.0% total mass loss (TML), < 0.1% collected volatile condensable material (CVCM).	ASTM E595										

Series 791 Plating Options and RoHS Finishes



European Union Directive 2011/65/EU, with amendment 2015/83, on Restriction of the use of certain Hazardous Substances (“RoHS”) states that certain types of equipment (primarily consumer electronic products such as personal computers) shall not contain lead, mercury, cadmium, hexavalent chromium, PBB, PBDE, DEHP, BBP, DBP, or DIBP.

The United States Department of Defense has issued a directive to minimize or eliminate the use of cadmium and hexavalent cadmium on DoD equipment. This directive has led to the adoption of nickel-PTFE and zinc-nickel shell platings as the preferred alternatives to traditional cadmium plating. Glenair has tested and approved these finishes for MIL-DTL-38999 and SAE AS85049.

The connectors in this catalog are available with three shell plating finishes: electroless nickel, nickel-PTFE and zinc-nickel. All three standard finishes are RoHS-compliant. Electroless nickel is the best choice for most applications. Nickel-PTFE has the conductivity of electroless nickel combined with superior corrosion resistance. Black zinc-nickel is a cadmium-free, corrosion-resistant finish typically used in tactical military equipment. Hermetic connectors feature stainless steel shells, passivated or nickel-plated. Please contact the factory to verify all components meet RoHS compliance regulations.

Table 1 lists the standard finishes in this catalog.

Table 2 lists additional shell plating options available on any Series 791 connector. To specify a Series 791 connector with one of these finishes, replace the catalog plating code with the alternate code shown below.

Table 1: RoHS-Compliant Standard Series 791 Shell Plating Options			
Plating Code	Description	Salt Spray Hours	Application Notes
M	Electroless Nickel	48	Standard finish for Series 791 connectors. Suitable for space programs. <i>ASTM B733 Category SC2</i>
MT	Nickel-PTFE	500	Higher corrosion resistance compared to electroless nickel. <i>SAE AMS2454</i>
ZR	Black Zinc-Nickel	500	DoD-approved alternative to olive-drab cadmium. Less conductive than M or MT. <i>ASTM B841 Type D</i>
Z1	Stainless Steel Shell, Passivated	1000	Used on 791-044 hermetic connectors.
ZL	Stainless Steel Shell, Nickel Plated	1000	Used on 791-044 hermetic connectors. Higher conductivity than Z1. <i>SAE AMS-QQ-N-290</i>

Table 2: Alternate Series 791 Plating Options

Plating Code	Description	Salt Spray Hours	RoHS Compliance	Application Notes
Z2	Gold	48		Alternative to electroless nickel for space programs. <i>MIL-DTL-45204</i>
J	Yellow Chromate over Cadmium	500	No	Widely used legacy finish for D Subminiature and rack-and-panel connectors. <i>SAE AMS-QQ-P-416</i>
NF	Olive Drab Chromate over Cadmium	500	No	Standard mil spec circular connector finish. <i>SAE AMS-QQ-P-416</i>
C	Black Anodize	336		Non-conductive, not suitable for EMI-protected equipment. <i>MIL-A-8625</i>

Series 791 Connectors for Space Flight



Is the Series 791 qualified and approved for space flight?

Yes. The connectors in this catalog are “good to go” for space flight. Zinc-nickel plated connectors should not be used for space applications. Electroless nickel is recommended.

Do Series 791 connectors meet outgassing requirements?

Connectors must be vacuum baked to guarantee compliance with outgassing limits established by NASA and military space programs. The requirements are 1.0 % Total Mass Loss (TML) and 0.1% Collected Volatile Condensable Material (CVCM). ASTM E595 defines the test procedure.

What is vacuum bakeout?

Connectors are placed in a special oven for 24 hours at +125°C and a vacuum of 10⁻⁶ Torr.

Are Series 791 connectors non-magnetic?

Series 791 connectors meet the 2.0μ magnetic permeability requirement of EIA-364-54. Additional residual magnetism screening is available on request.

Developed for the Orion spacecraft, the Series 791 connector is a high density, lightweight, high performance connector ideal for space flight applications. These connectors are available with NASA-grade screening and vacuum bakeout for high reliability space programs.

1. Find the right modification code in the table below.
2. Add the “Mod Code” to the connector part number.
Example: 791-003SH-66MP-**429C**

Space Grade Modifications Codes			
Modification Code	NASA Screening Level		Vacuum Bakeout 24 hours +125°C
	Level 1 Highest Reliability	Level 2 High Reliability	
429		●	
429A		●	●
429B	●		
429C	●		●
186M			●

NASA Screening Requirements (EEE-INST-002 Table 2C)		
Inspection/Test	NASA Screening Level	
	Level 1 Highest Reliability	Level 2 High Reliability
Visual Inspection	100% 10X magnification	100% 10X magnification
Mechanical Inspection	2 connectors 10X magnification	2 connectors 10X magnification
DWV/IR	2 connectors	2 connectors
Contact Separation Force (Connectors with non-removable contacts)	2 connectors	Not required
Mating and Unmating Force	2 connectors	Not required
Hermeticity (hermetic connectors only)	100%	100%
Vacuum Bakeout (Optional, depends on Mod code)	100%	100%

Series 791 Keying Options



Plug connector with key at position A

Prevent Mis-Mating with Mod Code 555 Keying Option

Series 791 connectors are available with an optional polarizing key. Keyed plug connectors have a raised boss on the shell as shown in the photograph at left. Receptacles have corresponding keyway in shell. Six key positions are available. Ordering is simple— just add the keying position letter designator to the end of the part number.

Application Note: keyed receptacles will plug into unkeyed plugs.

Ordering Information

Step 1	Create a Series 791 Part Number	791-004SH-66MS
Step 2	Add key position letter designator	791-004SH-66MSA

MOD-555 KEY LOCATIONS
PLUG CONNECTOR MATING FACE

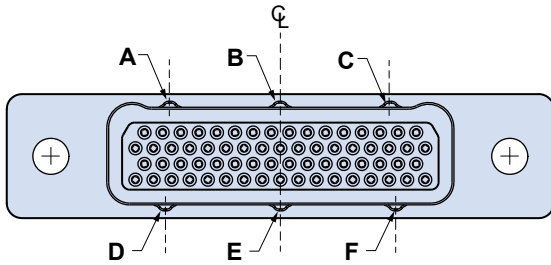

MOD-555 KEY LOCATIONS
RECEPTACLE CONNECTOR MATING FACE

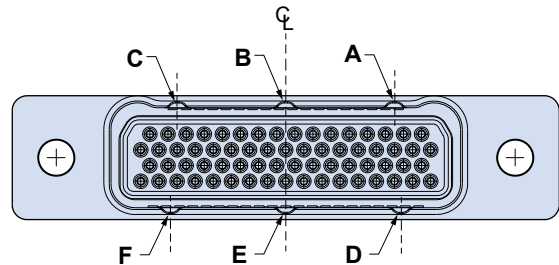

Key Positions

Shell Size	Key Position Offset From Vertical Centerline											
	Position A		Position B		Position C		Position D		Position E		Position F	
	In.	mm.	In.	mm.	In.	mm.	In.	mm.	In.	mm.	In.	mm.
A	.025	0.64	.000	.00	.025	0.64	–	–	.000	.00	–	–
B	.090	2.29	.000	.00	.090	2.29	.050	1.27	.000	.00	.050	1.27
C	.130	3.30	.000	.00	.130	3.30	.100	2.54	.000	.00	.100	2.54
D	.180	4.57	.000	.00	.180	4.57	.125	3.18	.000	.00	.125	3.18
E	.200	5.08	.000	.00	.200	5.08	.150	3.81	.000	.00	.150	3.81
F	.300	7.62	.000	.00	.300	7.62	.250	6.35	.000	.00	.250	6.35
G	.300	7.62	.000	.00	.300	7.62	.200	5.08	.000	.00	.200	5.08
H	.450	11.43	.000	.00	.450	11.43	.500	12.70	.000	.00	.500	12.70
J	.450	11.43	.000	.00	.450	11.43	.400	10.16	.000	.00	.400	10.16
K	.650	16.51	.000	.00	.650	16.51	.550	13.97	.000	.00	.550	13.97
L	.550	13.97	.000	.00	.550	13.97	.600	15.24	.000	.00	.600	15.24
M	.550	13.97	.000	.00	.550	13.97	.600	15.24	.000	.00	.600	15.24

Hermetic Receptacle Connectors

791-069 Rear-Panel Mount Hermetic Receptacles, Pin Face Scoop-Proof

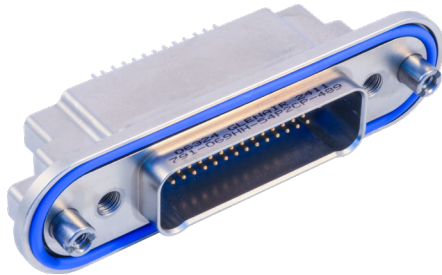

Pin Face Scoop-Proof. Panel Mount. 791 hermetic connectors are the next-generation higher density alternative to M24308 D Subminiature connectors. $<1 \times 10^{-7}$ sccHe/Sec @ 1 Atm. Delta. Kovar alloy / nickel plate shell, individual glass beads insulator, kovar alloy / gold plate contacts, fluorosilicone blend seal.

RELIABLE DESIGN

- Glass-to-metal seal
- 100% scoop-proof
- Stainless steel shell

VERSATILE

- Wide range of configurations
- Signal, power
- Blind mate

HARSH ENVIRONMENT

- Humidity, water ingress
- Shock and vibration
- Temperature extremes
- Corrosion resistance
- High altitude

SIZE AND WEIGHT SAVING

- High density

How To Order

Sample Part Number →	791-069	H	D	7P2	C	N
Product	791-069 Rear-Panel Mount Hermetic Receptacles, Pin Face Scoop-Proof					
Class	H = Hermetic					
Shell Size	A, B, C, D, E, F, J, K, G, H, L and M					
Arrangement	See Table 2					
Contact Type	C = Pin, P.C. Tail		P = Pin, Solder Cup			
Mating Hardware Option	N = No Mating Hardware P = Jackpost		G = Male Guide Pins S = Female Guide Sockets			

Specifications

- **Test Criteria:**
 - Hermeticity - $<1 \times 10^{-7}$ sccHe/Sec @ 1 Atm. Delta
- **D.W.V.**
 - #23 Pins: 500 Vac Pin-To-Shell
 - #16 Pins: 1800 Vac Pin-To-Shell
 - #12 Pins: 1800 Vac Pin-To-Shell
 - # 8 Pins: 1800 Vac Pin-To-Shell
 - I.R. - 5,000 Megohms Minimum @ 500 Vdc
- Glenair 791-069 will mate with any scoop-proof Series 79 plug with socket contacts and same shell and insert.
- Glenair 791-069 is designed to utilize 799-016 EMI backshells.

Construction

- **Shell:** Kovar Alloy / Nickel Plate
- **Contacts:** Kovar Alloy / Gold Plate
- **Insulator:** Vitreous Glass
- **Rear Spacers (Not Shown):** Rigid Dielectric
- **Seals:** Fluorosilicone Blend
- **Mating Hardware:** Cres / Passivated

TABLE IV

Contact Size	ø T
23	.022 (0.56); .018 (0.46)
16	.064 (1.63); .061 (1.55)
12	.095 (2.41); .093 (2.36)
8	.182 (4.62); .178 (4.52)

Hermetic Receptacle Connectors

791-069 Rear-Panel Mount Hermetic Receptacles, Pin Face Scoop-Proof

Table 1 Hardware Option











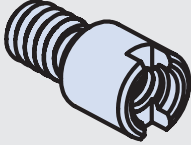
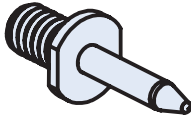
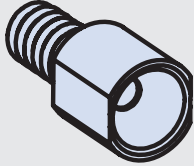

























 <p>P Jackpost</p> <p>Connector supplied with non-removable jackpost. Shell size "m" has 8-32 unc-2b thread. Shell sizes "h" And "l" have 6-32 unc-2b thread. All other sizes Have 4-40 unc-2b thread.</p>	 <p>G Guide Pins</p> <p>Connector supplied with non-removable guide pins for blind mate applications. Mates with option "S" guide socket on corresponding plug connector.</p>	 <p>B Guide Socket</p> <p>Connector supplied with non-removable guide sockets for blind mate applications. Mates with option "G" guide pin on corresponding plug connector.</p>
---	--	--

Table 2 Arrangement Number

Arrangements with Size #23 Contacts	Arrangements with Size #16 Contacts	Arrangements with Size #12 Contacts
 A-5 5 #23  B-9 9 #23  C-13 13 #23	 B-2P2 2 #16  D-3P3 3 #16  D-7P2 5 #23, 2 #16	 G-13P2 11 #23, 2 #12  G-3P3 3 #12
 D-15 15 #23  E-19 19 #23	 E-11P2 9 #23, 2 #16  E-7P3 4 #23, 3 #16  F-14P3 11 #23, 3 #16	 H-10P4 6 #23, 4 #12  H-36P2 34 #23, 2 #12
 F-23 23 #23  G-33 33 #23	 F-15P2 13 #23, 2 #16  F-5P5 5 #16	 H-5P5 5 #12
 H-66 66 #23  J-33 33 #23	 H-29P7 22 #23, 7 #16  H-54P2 52 #23, 2 #16	 L-6P6 6 #12
 K-43 43 #23	 J-17P4 13 #23, 4 #16  J-25P2 23 #23, 2 #16	
 L-78 78 #23	 J-7P7 7 #16  K-27P4 23 #23, 4 #16	
 M-102 102 #23	 K-35P2 33 #23, 2 #16  K-9P9 9 #16  M-17P17 17 #16	

Hermetic Receptacle Connectors

791-069 Rear-Panel Mount Hermetic Receptacles, Pin Face Scoop-Proof

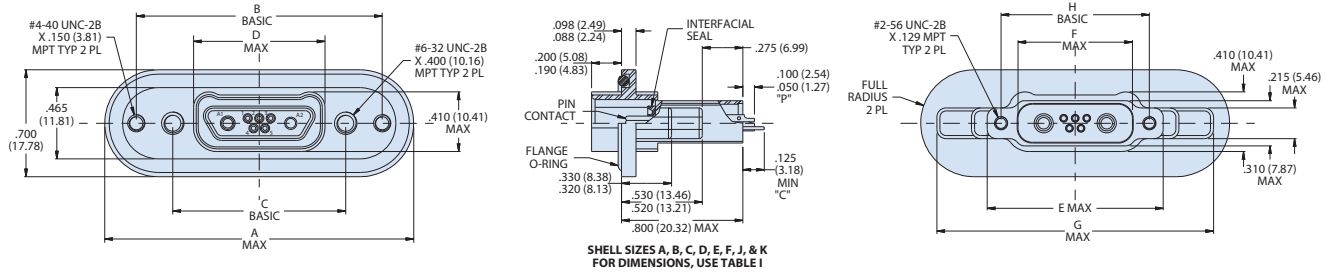

791-069 Dimensions

Shell Size	A Oal		B Basic		C Basic		D Max		E Max		F Max		G Max		H Basic	
	In.	mm.	In.	mm.	In.	mm.	In.	mm.	In.	mm.	In.	mm.	In.	mm.	In.	mm.
A	1.750	44.45	1.300	33.02	0.750	19.05	0.490	12.45	0.760	19.30	0.350	8.89	1.500	38.10	0.565	14.35
B	1.950	49.53	1.475	37.47	0.900	22.86	0.630	16.00	0.910	23.11	0.500	12.70	1.700	43.18	0.715	18.16
C	2.025	51.43	1.600	40.64	1.050	26.67	0.780	19.81	1.060	26.92	0.650	16.51	1.800	45.72	0.865	21.97
D	2.125	53.97	1.700	43.18	1.125	28.58	0.860	21.84	1.160	29.46	0.750	19.05	1.900	48.26	0.965	24.51
E	2.325	59.06	1.800	45.72	1.275	32.39	1.010	25.65	1.310	33.27	0.900	22.86	2.100	53.34	1.115	28.32
F	2.325	59.06	1.925	48.90	1.425	36.20	1.160	29.46	1.460	37.08	1.050	26.67	2.100	53.34	1.265	32.13
J	2.915	74.04	2.400	60.96	1.800	45.72	1.530	38.86	1.810	45.97	1.405	35.69	2.650	67.31	1.615	41.02
K	3.110	78.99	2.675	67.94	2.175	55.24	1.910	48.51	2.210	56.13	1.805	45.85	2.900	73.66	2.015	51.18

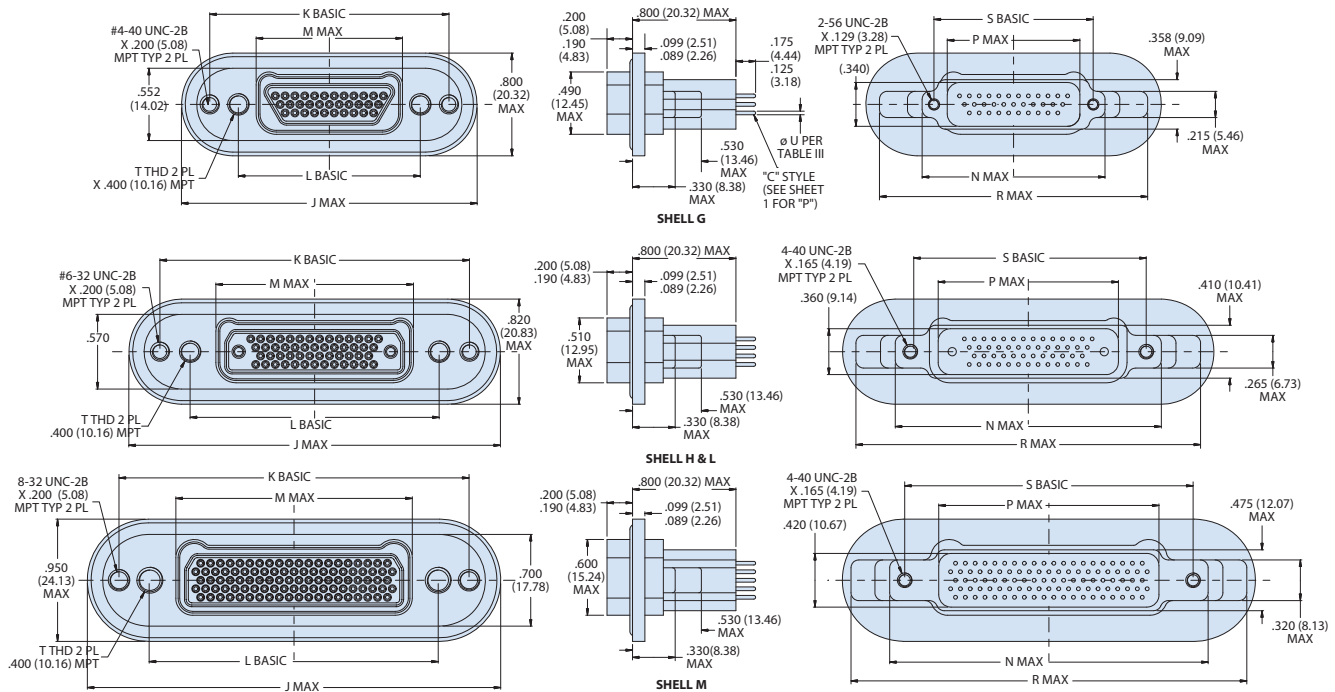

791-069 Dimensions

Shell Size	J Oal		K Basic		L Basic		M Max		N Max		P Max		R Max		S Basic		T Typ Unc 2-B
	In.	mm.	In.	mm.	In.	mm.	In.	mm.	In.	mm.	In.	mm.	In.	mm.	In.	mm.	
G	2.500	63.50	2.000	50.80	1.388	35.26	1.120	28.45	1.410	35.81	1.020	25.91	2.250	57.15	1.215	30.86	#6-32
H	3.050	77.47	2.500	63.50	1.900	48.26	1.510	38.35	2.045	51.94	1.385	35.18	2.850	72.39	1.800	45.72	#8-32
L	3.250	82.55	2.700	68.58	2.136	54.25	1.740	44.20	2.281	57.94	1.625	41.28	3.100	78.74	2.036	51.71	#8-32
M	3.375	85.73	2.870	72.90	2.200	55.88	1.800	45.72	2.485	63.12	1.690	42.93	3.200	81.28	2.200	55.88	#10-32

Hermetic Receptacle Connectors

791-069 Rear-Panel Mount Hermetic Receptacles, Pin Face Scoop-Proof

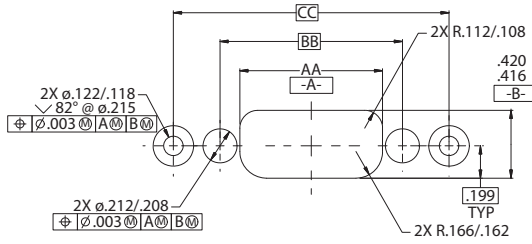

SHELL SIZES A, B, C, D, E, F, J, & K
FOR DIMENSIONS, USE TABLE IV

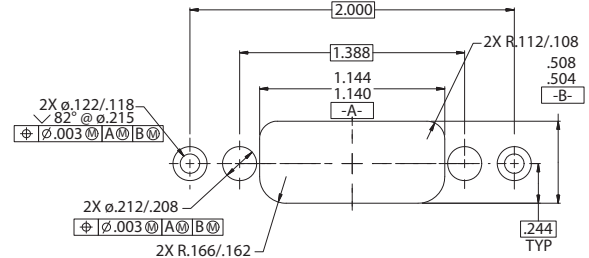

SHELL G

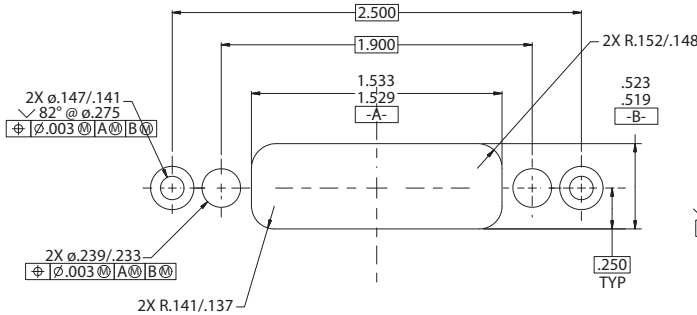

SHELL H

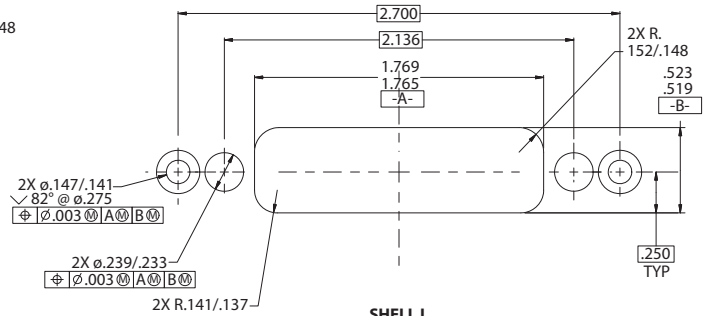

SHELL L

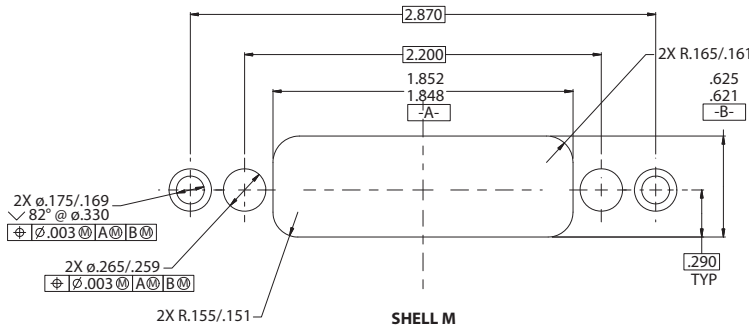

SHELL M

791-069 Dimensions

Shell Size	AA ±.002(0.05)		BB Basic		CC Basic	
	In.	mm.	In.	mm.	In.	mm.
A	0.505	12.83	0.750	19.05	1.300	33.02
B	0.655	16.64	0.900	22.86	1.475	37.47
C	0.805	20.45	1.050	26.67	1.600	40.64
D	0.880	22.35	1.125	28.58	1.700	43.18
E	1.030	26.16	1.275	32.39	1.800	45.72
F	1.180	29.97	1.425	36.20	1.925	48.90
J	1.555	39.50	1.800	45.72	2.400	60.96
K	1.930	49.02	2.175	55.24	2.675	67.94

Hermetic Receptacle Connectors

791-070 Rear-Panel Mount Hermetic Feedthrough, Pin - Socket Scoop-Proof

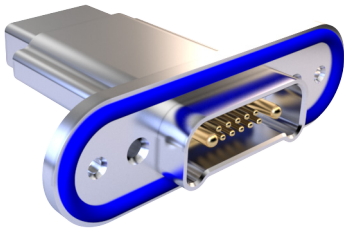

Pin Face Scoop-Proof. Rear-Panel Mount. 791 hermetic connectors are the next-generation higher density alternative to M24308 D Subminiature connectors. $<1 \times 10^{-6}$ sccHe/Sec @ 1 Atm. Delta. Kovar alloy / nickel plate shell, vitreous glass insulator, kovar alloy / gold plate hermetic contacts, copper alloy / gold plate socket contacts, fluorosilicone seal.

RELIABLE DESIGN

- Glass-to-metal seal
- 100% scoop-proof
- Stainless steel shell

VERSATILE

- Wide range of configurations
- Signal, power
- Blind mate

HARSH ENVIRONMENT

- Humidity, water ingress
- Shock and vibration
- Temperature extremes
- Corrosion resistance
- High altitude

SIZE AND WEIGHT SAVING

- High density

How To Order

Sample Part Number →	791-070	H	D	7P2	N
Product	791-070 Rear-Panel Mount Hermetic Feedthroughs, Pin-Socket Scoop-Proof				
Class	H = Hermetic				
Shell Size	A, B, C, D, E, F, J, K, G, H, L and M				
Arrangement	See Table 2				
Mating Hardware Option	N = No Mating Hardware P = Jackpost	G = Male Guide Pins S = Female Guide Sockets			

Specifications

Test Criteria:

- **Hermeticity:** $<1 \times 10^{-6}$ sccHe/Sec @ 1 Atm. Delta
- **D.W.V.**
 - #23 Pins: 500 Vac Pin-To-Shell
 - #16 Pins: 1800 Vac Pin-To-Shell
 - #12 Pins: 1800 Vac Pin-To-Shell
 - # 8 Pins: 1800 Vac Pin-To-Shell
 - I.R. - 5,000 Megohms Minimum @ 500 Vdc
- Glenair 791-070 will mate with any scoop-proof Series 79 plug and receptacle with same shell and insert.
- See sheet # 3 for panel cut-outs and mounting hardware information.

Construction

- **Shell:** Kovar Alloy / Nickel Plate
- **Contacts, Hermetic:** Kovar Alloy / Gold Plate
- **Contacts, Sockets:** Copper Alloy / Gold Plate
- **Insulator, Hermetic:** Vitreous Glass
- **Insulator, Socket:** Rigid Dielectric
- **Seals, O-Ring:** Fluorosilicone
- **Mating Hardware:** Cres / Passivated

Hermetic Receptacle Connectors

791-070 Rear-Panel Mount Hermetic Feedthrough, Pin - Socket Scoop-Proof

Table 1 Hardware Option











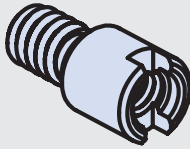
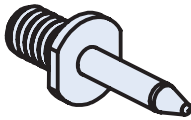
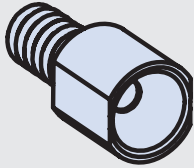

























 <p>P Jackpost</p> <p>Connector supplied with non-removable jackpost. Shell size "m" has 8-32 unc-2b thread. Shell sizes "h" And "l" have 6-32 unc-2b thread. All other sizes Have 4-40 unc-2b thread.</p>	 <p>G Guide Pins</p> <p>Connector supplied with non-removable guide pins for blind mate applications. Mates with option "S" guide socket on corresponding plug connector.</p>	 <p>B Guide Socket</p> <p>Connector supplied with non-removable guide sockets for blind mate applications. Mates with option "G" guide pin on corresponding plug connector.</p>
---	--	--

Table 2 Arrangement Number

Arrangements with Size #23 Contacts	Arrangements with Size #16 Contacts	Arrangements with Size #12 Contacts
 A-5 5 #23  B-9 9 #23  C-13 13 #23	 B-2P2 2 #16  D-3P3 3 #16  D-7P2 5 #23, 2 #16	 G-13P2 11 #23, 2 #12  G-3P3 3 #12
 D-15 15 #23  E-19 19 #23	 E-11P2 9 #23, 2 #16  E-7P3 4 #23, 3 #16  F-14P3 11 #23, 3 #16	 H-10P4 6 #23, 4 #12  H-36P2 34 #23, 2 #12
 F-23 23 #23  G-33 33 #23	 F-15P2 13 #23, 2 #16  F-5P5 5 #16	 H-5P5 5 #12
 H-66 66 #23  J-33 33 #23	 H-29P7 22 #23, 7 #16  H-54P2 52 #23, 2 #16	 L-6P6 6 #12
 K-43 43 #23	 J-17P4 13 #23, 4 #16  J-25P2 23 #23, 2 #16	
 L-78 78 #23	 J-7P7 7 #16  K-27P4 23 #23, 4 #16	
 M-102 102 #23	 K-35P2 33 #23, 2 #16  K-9P9 9 #16  M-17P17 17 #16	

Hermetic Receptacle Connectors

791-070 Rear-Panel Mount Hermetic Feedthrough, Pin - Socket Scoop-Proof

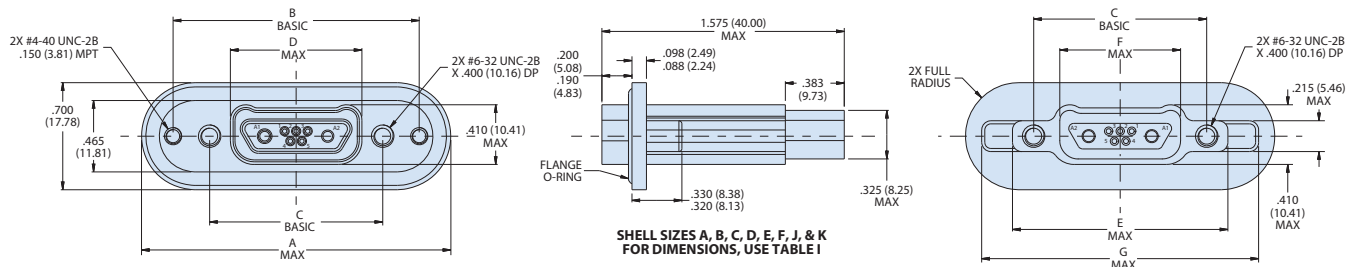

791-070 Dimensions

Shell Size	A Oal		B Basic		C Basic		D Max		E Max		F Max		G Max	
	In.	mm.	In.	mm.	In.	mm.	In.	mm.	In.	mm.	In.	mm.	In.	mm.
A	1.750	44.45	1.300	33.02	0.750	19.05	0.490	12.45	0.565	14.35	0.410	10.41	1.035	26.29
B	1.950	49.53	1.475	37.47	0.900	22.86	0.630	16.00	0.715	18.16	0.560	14.22	1.185	30.10
C	2.025	51.43	1.600	40.64	1.050	26.67	0.780	19.81	0.865	21.97	0.710	18.03	1.335	33.91
D	2.125	53.97	1.700	43.18	1.125	28.58	0.860	21.84	0.965	24.51	0.785	19.94	1.410	35.81
E	2.325	59.06	1.800	45.72	1.275	32.39	1.010	25.65	1.115	28.32	0.935	23.75	1.560	39.62
F	2.325	59.06	1.925	48.90	1.425	36.20	1.160	29.46	1.265	32.13	1.085	27.56	1.710	43.43
J	2.915	74.04	2.400	60.96	1.800	45.72	1.530	38.86	1.615	41.02	1.460	37.08	2.085	52.96
K	3.110	78.99	2.675	67.94	2.175	55.24	1.910	48.51	2.015	51.18	1.835	46.61	2.460	62.48

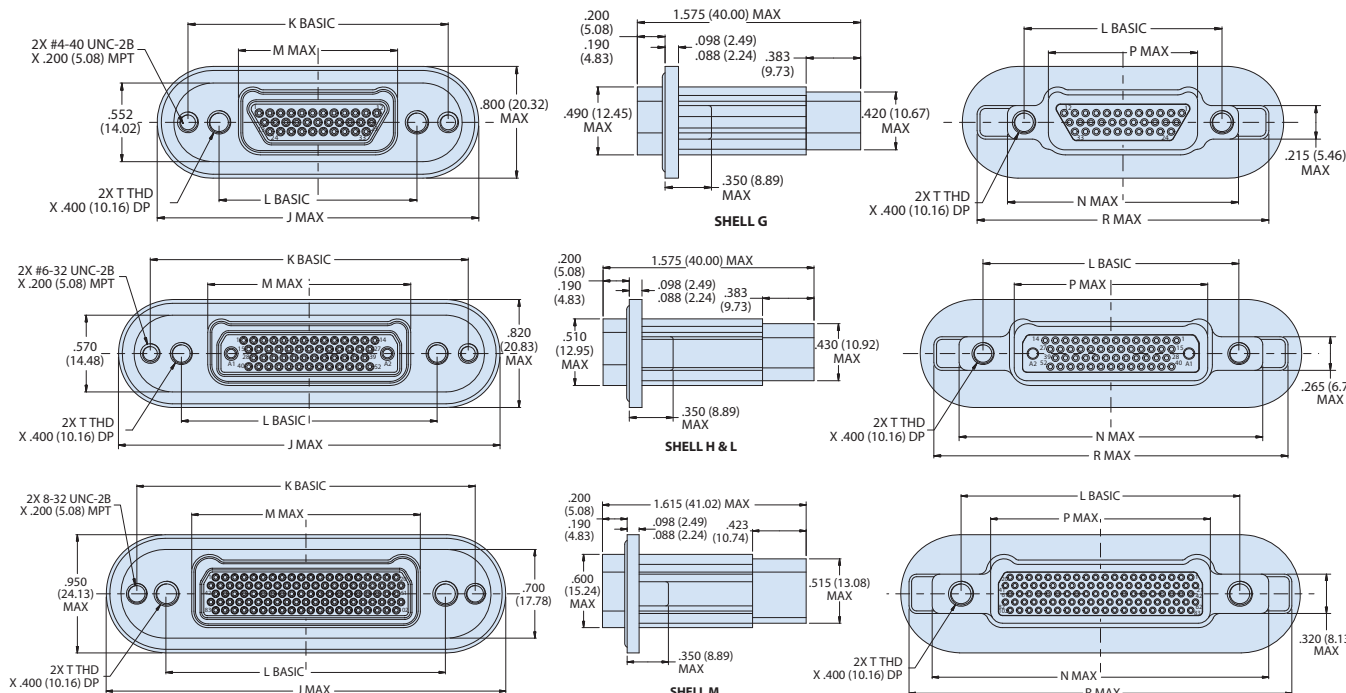

791-070 Dimensions

Shell Size	J Oal		K Basic		L Basic		M Max		N Max		P Max		R Max		S Basic		T Typ Unc 2-B
	In.	mm.	In.	mm.	In.	mm.	In.	mm.	In.	mm.	In.	mm.	In.	mm.	In.	mm.	
G	2.500	63.50	2.000	50.80	1.388	35.26	1.120	28.45	1.675	42.55	1.060	26.92	2.250	57.15	1.215	30.86	#6-32
H	3.050	77.47	2.500	63.50	1.900	48.26	1.510	38.35	2.275	57.79	1.442	36.63	2.850	72.39	1.800	45.72	#8-32
L	3.250	82.55	2.700	68.58	2.136	54.25	1.740	44.20	2.515	63.88	1.678	42.62	3.100	78.74	2.036	51.71	#8-32
M	3.375	85.73	2.870	72.90	2.200	55.88	1.800	45.72	2.580	65.53	1.745	44.32	3.200	81.28	2.200	55.88	#10-32

Hermetic Receptacle Connectors

791-070 Rear-Panel Mount Hermetic Feedthrough, Pin - Socket Scoop-Proof

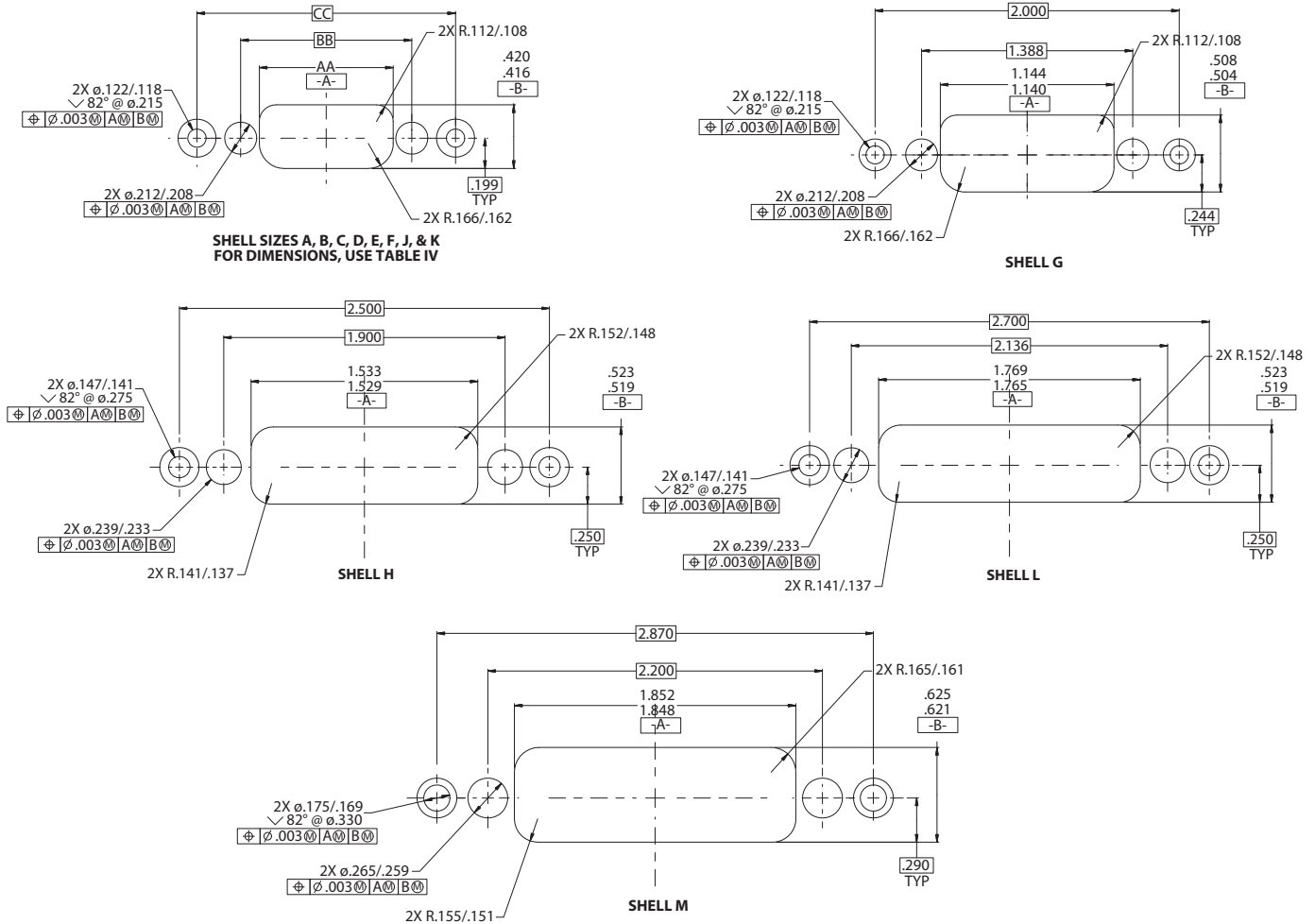

791-070 Dimensions

Shell Size	AA ±.002(0.05)		BB Basic		CC Basic	
	In.	mm.	In.	mm.	In.	mm.
A	0.505	12.83	0.750	19.05	1.300	33.02
B	0.655	16.64	0.900	22.86	1.475	37.47
C	0.805	20.45	1.050	26.67	1.600	40.64
D	0.880	22.35	1.125	28.58	1.700	43.18
E	1.030	26.16	1.275	32.39	1.800	45.72
F	1.180	29.97	1.425	36.20	1.925	48.90
J	1.555	39.50	1.800	45.72	2.400	60.96
K	1.930	49.02	2.175	55.24	2.675	67.94

Cable Connectors with Crimp-and-Poke Contacts

791-003S, 791-004S Plug Connectors with Socket Contacts

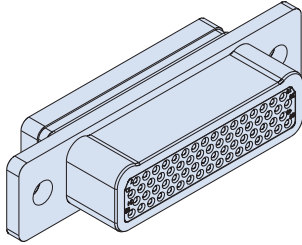

791-003S
With Backshell Groove

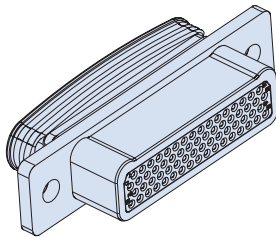

791-004S
With Integral Banding Platform

Harsh environment. Rugged construction. Ultraminiature. Series 791 connectors save size and weight compared to M24308 D Subminiature and other rack-and-panel connectors. Machined aluminum shell with polarizing lobes, snap-in crimp contacts, military grade materials, finishes and construction. Mating receptacles feature scoop-proof recessed pins for problem-free service.

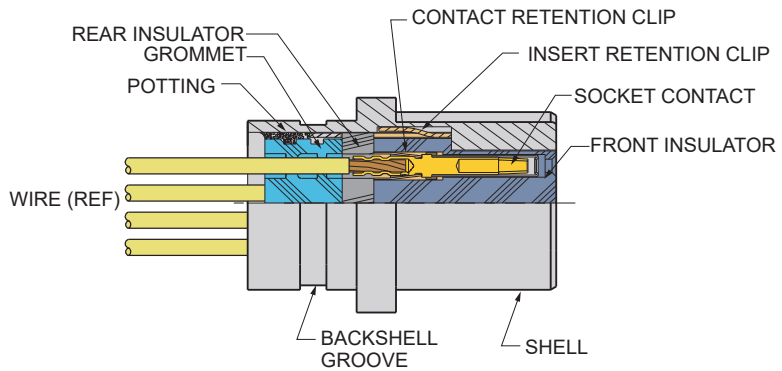

RELIABLE DESIGN

- 100% scoop-proof
- Snap-in, rear release contacts
- EMI shell-to-shell continuity

VERSATILE

- Wide range of configurations
- Signal, power, RF, datalink
- Banding platform

HARSH ENVIRONMENT

- Humidity, water ingress
- Shock and vibration
- Temperature extremes
- Corrosion resistance
- High altitude

SIZE AND WEIGHT SAVING

- High density

How To Order

Sample Part Number	791-003S	H-66	M	P
Product	791-003S = Cable Plug, Socket Contacts, Backshell Groove 791-004S = Cable Plug, Socket Contacts, Integral Banding Platform			
Arrangement Number (Shell Size - Insert Arr.)	See Table 2			
Shell Finish	M = Electroless Nickel MT = Nickel-PTFE ZR = Black Zinc-Nickel			
Hardware Option (Table 1)	N = Thru-Hole (no hardware) S = Low Profile Screwlock, Hex Head T = Extended Screwlock, Slot Head L = Low Profile Jackscrew, Hex Head K = Extended Jackscrew, Slot Head P = Jackpost			

Specifications

- Operating temperature: -65 to +150°C
- Current and voltage ratings:

Contact Size	Amps, max.	DWV Vac rms
23	5	750
16	13	1800
12	23	1800
8	46	1800

- Shock: EIA-364-27 condition D
- Vibration: EIA-364-28 condition V, letter E
- See pages 8-10 for Series 79 Product Specifications (ref: 799-008)

Construction

- Shell: aluminum alloy
- Insulators: high grade rigid dielectric
- Contacts: copper alloy, 50 microinches gold over nickel plating
- Socket contact hood: stainless steel, passivated
- Wire grommet: fluorosilicone blend
- Contact retention clip, insert retention clip: beryllium copper
- Hardware: stainless steel, passivated

Wire Accommodation

Contact Size	Wire Range AWG
23	22 – 28
16	16 – 20
12	12 – 14
8	8

Cable Connectors with Crimp-and-Poke Contacts

791-003S, 791-004S Plug Connectors with Socket Contacts

Table 1 Hardware Option

Thread Sizes					
Hardware thread sizes vary by shell size. Shell sizes A, B, C, D, E, F, G, J, K have #4-40 UNC-2 thread, shell sizes H and L have #6-32 UNC-2 thread, shell size M has #8-32 UNC-2 thread.					
<p>N No Hardware Mounting flange has thru-holes.</p>	<p>P Jackpost Supplied loosely assembled with nut and split washer. Stainless steel.</p> <p>.190 (4.83) MAX</p>	<p>L Low Profile Jackscrew Non-removable, hex head. Stainless steel.</p> <p>.155 (3.94) MAX</p>	<p>K Extended Jackscrew Slot head, stainless steel, non-removable.</p> <p>.925 (23.5) MAX</p>	<p>S Low Profile Screwlock Hex head, stainless steel, non-removable. Screwlocks allow the connector to be mated before the screws are fastened.</p> <p>.290 (7.37) MAX</p>	<p>T Extended Screwlocks Slot head, stainless steel, non-removable. Screwlocks allow the connector to be mated before the screws are fastened.</p> <p>.925 (23.5) MAX</p>

Table 2 Arrangement Number

Change the "P" to a "W" in any combo arrangement to delete power contacts. For example, arrangement **H-10P4** is supplied with a total of 10 contacts including (4) #12 power pins and (6) signal pins. Arrangement **H-10W4** is supplied with (6) signal pins and no power pins. Order coax contacts separately.

Arrangements with Size #23 Contacts	Arrangements with Size #16 Contacts	Arrangements with Size #12 Contacts
<p>A-5 5 #23</p> <p>B-9 9 #23</p> <p>C-13 13 #23</p>	<p>B-2P2 2 #16</p> <p>D-3P3 3 #16</p> <p>D-7P2 5 #23, 2 #16</p>	<p>G-13P2 11 #23, 2 #12</p> <p>G-3P3 3 #12</p> <p>G-21P1 20 #23, 1 #12</p>
<p>D-15 15 #23</p> <p>E-19 19 #23</p>	<p>E-11P2 9 #23, 2 #16</p> <p>E-7P3 4 #23, 3 #16</p> <p>F-14P3 11 #23, 3 #16</p>	<p>H-10P4 6 #23, 4 #12</p> <p>H-36P2 34 #23, 2 #12</p>
<p>F-23 23 #23</p> <p>G-33 33 #23</p>	<p>F-15P2 13 #23, 2 #16</p> <p>F-5P5 5 #16</p>	<p>H-5P5 5 #12</p>
<p>H-66 66 #23</p> <p>J-33 33 #23</p>	<p>H-29P7 22 #23, 7 #16</p> <p>H-54P2 52 #23, 2 #16</p>	<p>L-6P6 6 #12</p>
<p>K-43 43 #23</p>	<p>J-17P4 13 #23, 4 #16</p> <p>J-25P2 23 #23, 2 #16</p>	<p>Arrangements with Size #8 Contacts</p> <p>M-4P4 Supplied with 4 #8 Power Contacts</p> <p>M-4W4 Contacts ordered separately, dielectric insert</p> <p>M-4G4 contacts ordered separately, metal insert</p>
<p>L-78 78 #23</p>	<p>J-7P7 7 #16</p> <p>K-27P4 23 #23, 4 #16</p>	
<p>M-102 102 #23</p>	<p>K-35P2 33 #23, 2 #16</p> <p>K-9P9 9 #16</p>	
	<p>M-17P17 17 #16</p>	

Cable Connectors with Crimp-and-Poke Contacts

791-003S, 791-004S Plug Connectors with Socket Contacts

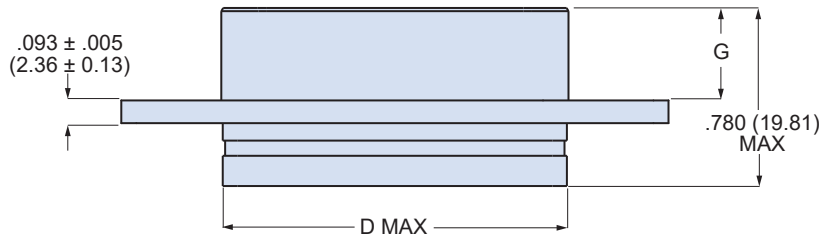
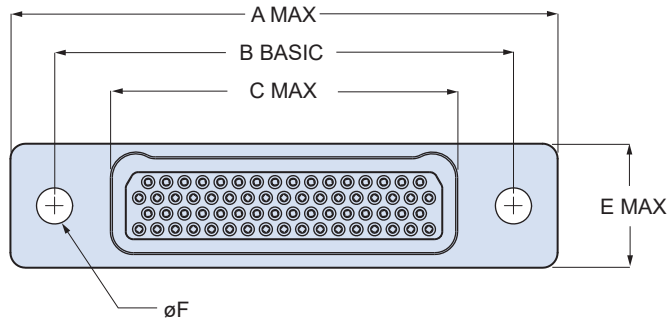

791-003S WITH BACKSHELL GROOVE

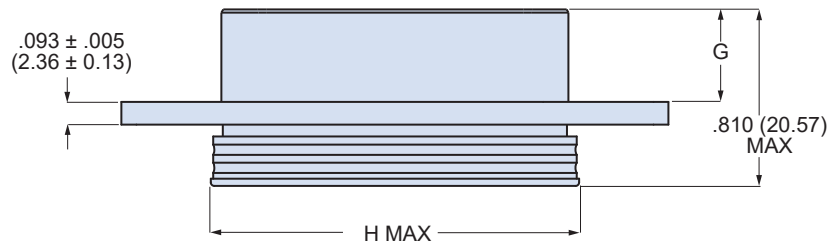

791-004S WITH INTEGRAL BANDING PLATFORM

Crimp Tools			
Contact Size	Crimper	Positioner	Die
23	809-015 (M22520/2-01)	809-005 (no mil spec #)	(not required)
16	809-136 (M22520/1-01)	809-137 (M22520/1-04)	(not required)
12	809-136 (M22520/1-01)	809-137 (M22520/1-04)	(not required)
8	859-025 (M22520/23-01)	859-046 (WA23-395L)	859-026 (M22520/23-02)

Note: see "Contacts and Tools" section for additional information

Insertion/Removal Tools	
Contact Size	Insertion/Removal Tool
23	809-088 (no mil spec #)
16	809-131 (M81969/14-03)
12	809-132 (M81969/14-04)
8	859-049 (M81969/14-12)

Band-Master® Shield Termination

790-004S plugs with integral banding platform are for use with Glenair **Band-Master®** micro-bands and installation tools.

791-003S and 791-004S Dimensions

Shell Size	A Max		B Basic		C Max		D Max		E Max		F Dia ±.005 (0.13)		G ±.003 (0.08)		H Max	
	In.	mm.	In.	mm.	In.	mm.	In.	mm.	In.	mm.	In.	mm.	In.	mm.	In.	mm.
A	1.035	26.29	.750	19.05	.415	1.054	.390	9.91	.415	10.54	.150	3.81	.383	9.73	.450	11.43
B	1.185	30.10	.900	22.86	.565	1.435	.540	13.72	.415	10.54	.150	3.81	.383	9.73	.600	15.24
C	1.335	33.91	1.050	26.67	.715	1.816	.690	17.53	.415	10.54	.150	3.81	.383	9.73	.750	19.05
D	1.410	35.81	1.125	28.58	.790	2.007	.790	20.07	.415	10.54	.150	3.81	.383	9.73	.850	21.59
E	1.560	39.62	1.275	32.39	.940	2.388	.940	23.88	.415	10.54	.150	3.81	.383	9.73	1.000	25.40
F	1.710	43.43	1.425	36.20	1.090	2.769	1.090	27.69	.415	10.54	.150	3.81	.383	9.73	1.150	29.21
G	1.673	42.49	1.388	35.25	1.052	2.672	1.090	27.69	.500	12.70	.150	3.81	.383	9.73	1.140	28.96
H	2.275	57.79	1.900	48.26	1.442	3.663	1.440	36.58	.520	13.21	.173	4.39	.383	9.73	1.535	38.99
J	2.085	52.96	1.800	45.72	1.465	3.721	1.450	36.83	.415	10.54	.150	3.81	.383	9.73	1.500	38.10
K	2.460	60.96	2.175	55.25	1.840	4.674	1.840	46.74	.415	10.54	.150	3.81	.383	9.73	1.900	48.26
L	2.511	63.78	2.136	54.26	1.678	4.262	1.675	42.55	.520	13.21	.173	4.39	.383	9.73	1.770	44.96
M	2.580	65.53	2.200	55.88	1.745	4.432	1.735	44.07	.635	16.13	.198	5.03	.423	10.74	1.835	46.60

Cable Connectors with Crimp-and-Poke Contacts

791-001P, 791-002P Receptacle Connectors with Pin Contacts

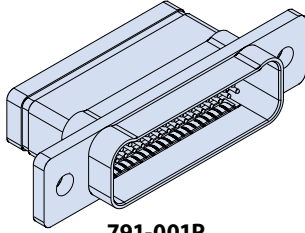

791-001P
With Backshell Groove

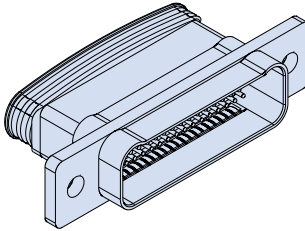

791-002P
With Integral Banding Platform

Harsh environment. Rugged construction. Ultraminiature. Series 791 connectors save size and weight compared to M24308 D Subminiature and other rack-and-panel connectors. Crimp, snap-in machined socket contacts. Ruggedized dual lobe shell, recessed pins and ground spring for improved shielding.

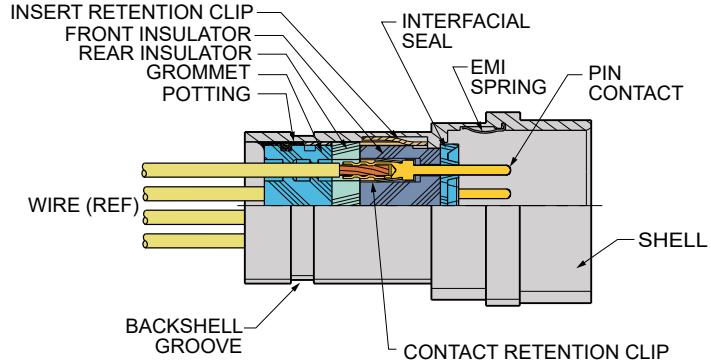

RELIABLE DESIGN

- 100% scoop-proof
- Snap-in, rear release contacts

VERSATILE

- Wide range of configurations
- Signal, power, RF, datalink
- Banding platform

HARSH ENVIRONMENT

- Humidity, water ingress
- Shock and vibration
- Temperature extremes
- Corrosion resistance
- High altitude

SIZE AND WEIGHT SAVING

- High density

Wire Accommodation

Contact Size	Wire Range AWG
23	22 – 28
16	16 – 20
12	12 – 14
8	8

How To Order

Sample Part Number	791-001P	M-102	MT	E	S
Product	791-001P = Cable Receptacle, Pin Contacts, Backshell Groove 791-002P = Cable Receptacle, Pin Contacts, Integral Banding Platform				
Arrangement Number (Shell Size - Insert Arr.)	See Table 2				
Shell Finish	M = Electroless Nickel MT = Nickel-PTFE ZR = Black Zinc-Nickel				
EMI Spring	E = EMI spring N = No EMI spring				
Hardware Option (Table 1)	N = Thru-Hole (no hardware) S = Low Profile Screwlock, Hex Head T = Extended Screwlock, Slot Head L = Low Profile Jackscrew, Hex Head K = Extended Jackscrew, Slot Head P = Jackpost				

Specifications

- Operating temperature: -65 to +150°C
- Current and voltage ratings:

Contact Size	Amps, max.	DWV Vac rms
23	5	750
16	13	1800
12	23	1800
8	46	1800

- Shock: EIA-364-27 condition D
- Vibration: EIA-364-28 condition V, letter E
- See pages 8-10 for additional information

Construction

- Shell: aluminum alloy
- Insulators: high grade rigid dielectric
- Contacts: copper alloy, 50 microinches gold over nickel plating
- Interfacial seal: fluorosilicone blend
- Wire grommet: fluorosilicone blend
- Contact retention clip, insert retention clip: beryllium copper
- EMI spring: beryllium copper, nickel plated
- Hardware: 300 series stainless steel, passivated

Cable Connectors with Crimp-and-Poke Contacts

791-001P, 791-002P Receptacle Connectors with Pin Contacts

Table 1 Hardware Option

Thread Sizes					
Hardware thread sizes vary by shell size. Shell sizes A, B, C, D, E, F, G, J, K have #4-40 UNC-2 thread, shell sizes H and L have #6-32 UNC-2 thread, shell size M has #8-32 UNC-2 thread.					
<p>N No Hardware Mounting flange has thru-holes.</p>	<p>P Jackpost Supplied loosely assembled with nut and split washer. Stainless steel.</p>	<p>L Low Profile Jackscrew Non-removable, hex head. Stainless steel.</p>	<p>K Extended Jackscrew Slot head, stainless steel, non-removable.</p>	<p>S Low Profile Screwlock Hex head, stainless steel, non-removable. Screwlocks allow the connector to be mated before the screws are fastened.</p>	<p>T Extended Screwlocks Slot head, stainless steel, non-removable. Screwlocks allow the connector to be mated before the screws are fastened.</p>

Table 2 Arrangement Number

Change the "P" to a "W" in any combo arrangement to delete power contacts. For example, arrangement **H-10P4** is supplied with a total of 10 contacts including (4) #12 power pins and (6) signal pins. Arrangement **H-10W4** is supplied with (6) signal pins and no power pins. Order coax contacts separately.

Arrangements with Size #23 Contacts	Arrangements with Size #16 Contacts	Arrangements with Size #12 Contacts
<p>A-5 5 #23</p> <p>B-9 9 #23</p> <p>C-13 13 #23</p>	<p>B-2P2 2 #16</p> <p>D-3P3 3 #16</p> <p>D-7P2 5 #23, 2 #16</p>	<p>G-13P2 11 #23, 2 #12</p> <p>G-3P3 3 #12</p> <p>G-21P1 20 #23, 1 #12</p>
<p>D-15 15 #23</p> <p>E-19 19 #23</p>	<p>E-11P2 9 #23, 2 #16</p> <p>E-7P3 4 #23, 3 #16</p> <p>F-14P3 11 #23, 3 #16</p>	<p>H-10P4 6 #23, 4 #12</p> <p>H-36P2 34 #23, 2 #12</p>
<p>F-23 23 #23</p> <p>G-33 33 #23</p>	<p>F-15P2 13 #23, 2 #16</p> <p>F-5P5 5 #16</p>	<p>H-5P5 5 #12</p>
<p>H-66 66 #23</p> <p>J-33 33 #23</p>	<p>H-29P7 22 #23, 7 #16</p> <p>H-54P2 52 #23, 2 #16</p>	<p>L-6P6 6 #12</p>
<p>K-43 43 #23</p>	<p>J-17P4 13 #23, 4 #16</p> <p>J-25P2 23 #23, 2 #16</p>	<p>Arrangements with Size #8 Contacts</p> <p>M-4P4 Supplied with 4 #8 Power Contacts</p> <p>M-4W4 Contacts ordered separately, dielectric insert</p> <p>M-4G4 contacts ordered separately, metal insert</p>
<p>L-78 78 #23</p>	<p>J-7P7 7 #16</p> <p>K-27P4 23 #23, 4 #16</p>	
<p>M-102 102 #23</p>	<p>K-35P2 33 #23, 2 #16</p> <p>K-9P9 9 #16</p>	
	<p>M-17P17 17 #16</p>	

Cable Connectors with Crimp-and-Poke Contacts

791-001P, 791-002P Receptacle Connectors with Pin Contacts

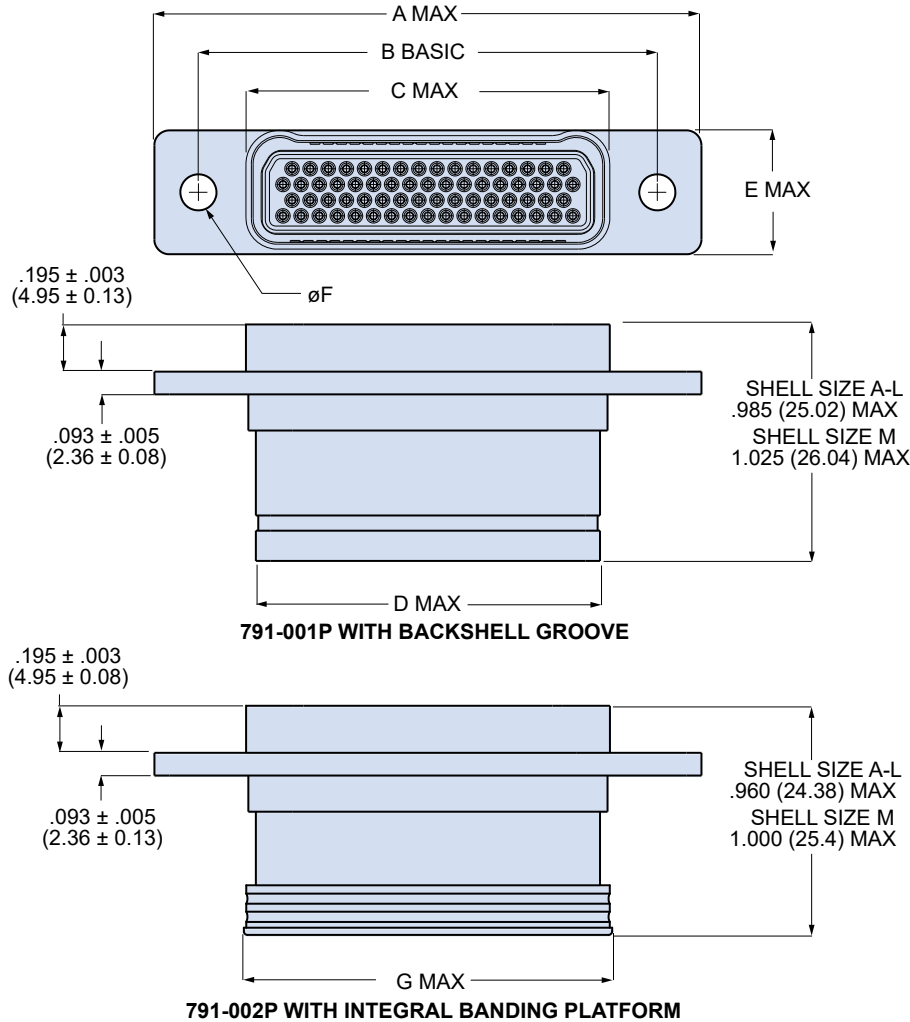

Crimp Tools			
Contact Size	Crimper	Positioner	Die
23	809-015 (M22520/2-01)	809-005 (no mil spec #)	(not required)
16	809-136 (M22520/1-01)	809-137 (M22520/1-04)	(not required)
12	809-136 (M22520/1-01)	809-137 (M22520/1-04)	(not required)
8	859-025 (M22520/23-01)	859-046 (WA23-395L)	859-026 (M22520/23-02)

Note: see "Contacts and Tools" section for additional information

Insertion/Removal Tools	
Contact Size	Insertion/Removal Tool
23	809-088 (no mil spec #)
16	809-131 (M81969/14-03)
12	809-132 (M81969/14-04)
8	859-049 (M81969/14-12)

Band-Master® Shield Termination

790-002P receptacles with integral banding platform are for use with Glenair **Band-Master®** micro-bands and installation tools.

791-001P and 791-002P Dimensions

Shell Size	A Max		B Basic		C Max		D Max		E Max		F Dia ±.004 (0.10)		G Max ±.010 (0.25)	
	In.	mm.	In.	mm.	In.	mm.	In.	mm.	In.	mm.	In.	mm.	In.	mm.
A	1.040	26.42	.750	19.05	.490	12.45	.390	9.91	.415	10.54	.149	3.78	.440	11.18
B	1.190	30.23	.900	22.86	.640	16.26	.540	13.72	.415	10.54	.149	3.78	.590	14.99
C	1.340	34.04	1.050	26.67	.790	20.07	.690	17.53	.415	10.54	.149	3.78	.740	18.80
D	1.415	35.94	1.125	28.58	.865	21.97	.790	20.07	.415	10.54	.149	3.78	.840	21.34
E	1.565	39.75	1.275	32.39	1.015	25.78	.940	23.88	.415	10.54	.149	3.78	.990	25.15
F	1.715	43.56	1.425	36.20	1.165	29.59	1.090	27.69	.415	10.54	.149	3.78	1.140	28.96
G	1.678	42.62	1.388	35.26	1.127	28.63	1.090	27.69	.500	12.70	.149	3.78	1.130	28.70
H	2.275	57.79	1.900	48.26	1.516	38.51	1.440	36.58	.520	13.21	.172	4.37	1.525	38.74
J	2.090	53.09	1.800	45.72	1.540	39.12	1.450	36.83	.415	10.54	.149	3.78	1.490	37.85
K	2.465	62.61	2.175	55.25	1.915	48.64	1.840	46.74	.415	10.54	.149	3.78	1.890	48.01
L	2.511	63.78	2.136	54.26	1.752	44.50	1.675	42.55	.520	13.21	.172	4.37	1.760	44.70
M	2.580	65.53	2.200	55.88	1.815	46.10	1.740	44.20	.635	16.13	.200	5.08	1.825	46.36

Panel Mount Connectors with Crimp-and-Poke Contacts

791-020S Panel Mount Plug Connectors with Socket Contacts

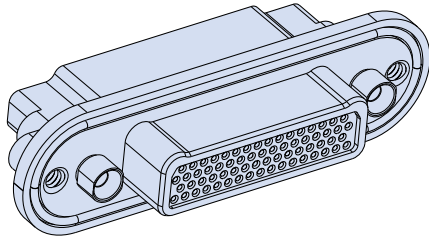

791-020S
Panel Mount Plug

RELIABLE DESIGN

- 100% scoop-proof
- Snap-in, rear release contacts
- EMI shell-to-shell continuity
- Blind mate capability

VERSATILE

- Wide range of configurations
- Signal, power, RF, datalink
- Rear panel mount

HARSH ENVIRONMENT

- Humidity, water ingress
- Shock and vibration
- Temperature extremes
- Corrosion resistance
- High altitude

SIZE AND WEIGHT SAVING

- High density

Blind mate. Scoop-proof. Ultriminiature. Series 791 connectors save size and weight compared to M24308 D Subminiature and other rack-and-panel connectors. Dual lobe shell for foolproof mating. Crimp, snap-in, rear release machined socket contacts. Environmentally protected with rubber wire grommet, face seal and O-ring. Aluminum shell, thermoplastic insulators and metal contact retention clips. Contacts are packaged with connector.

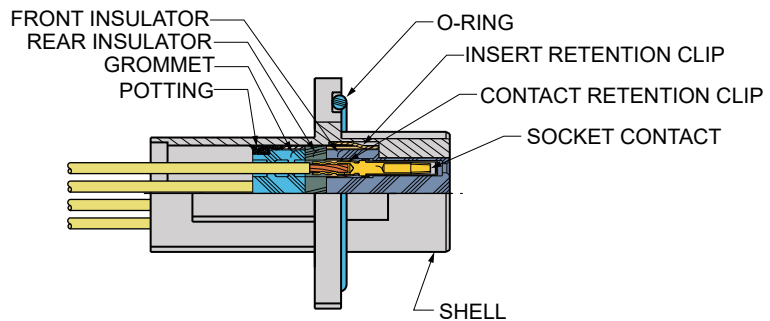

How To Order

Sample Part Number	791-020S	J-17P4	M	P	F
Product	791-020S = Panel Mount Plug, Crimp, with Socket Contacts				
Arrangement Number (Shell Size - Insert Arr.)	See Table 2				
Shell Finish	M = Electroless Nickel MT = Nickel-PTFE ZR = Black Zinc-Nickel				
Hardware Option (Table 1)	N = No hardware P = Jackpost G = Male guide pin B = Female guide bushing				
O-ring Option	N = No O-ring F = Fluorosilicone O-ring (non-conductive) C = Conductive fluorosilicone O-ring S = Metal EMI panel spring (non-environmental)				

Metal EMI Panel Spring

Gold-plated panel spring provides improved electrical bonding. Specify Code S.
Non-environmental.



Wire Accommodation

Contact Size	Wire Range AWG
23	22 – 28
16	16 – 20
12	12 – 14
8	8

Specifications

- Operating temperature: -65 to +150°C
- Current and voltage ratings:

Contact Size	Amps, max.	DWV Vac rms
23	5	750
16	13	1800
12	23	1800
8	46	1800
- Shock: EIA-364-27 condition D
- Vibration: EIA-364-28 condition V, letter E
- See pages 8-10 for additional information

Construction

- Shell: aluminum alloy
- Insulators: high grade rigid dielectric
- Contacts: copper alloy, 50 microinches gold over nickel plating
- Encapsulant: epoxy
- O-ring: fluorosilicone
- Hardware: stainless steel, passivated
- O-ring (code F): fluorosilicone
- Conductive O-ring (code C): silver plated, aluminum-filled fluorosilicone
- Metal EMI panel spring (code S): beryllium copper, gold plated

Panel Mount Connectors with Crimp-and-Poke Contacts

791-020S Panel Mount Plug Connectors with Socket Contacts

Table 1 Hardware Option











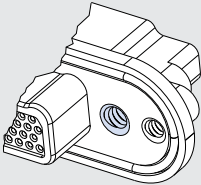
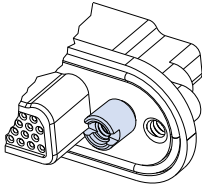
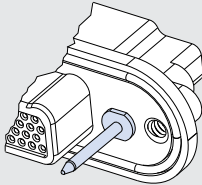
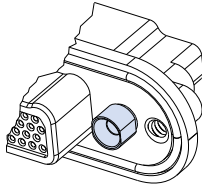



















 N No Hardware Connector supplied with threaded holes, .150 (3.8) minimum depth. Shell sizes A-G, J, K have 6-32 UNC-2B thread, sizes H and L have 8-32 UNC-2B thread. Size M has 10-32 UNF-2B thread.	 P Jackposts Non-removable female jackpost. Shell sizes A-G, J, K have 4-40 UNC-2B thread, sizes H and L have 6-32 UNC-2B thread. Size M has 8-32 UNC-2B thread. 300 series stainless steel, passivated.	 G Guide Pins Non-removable, 300 series stainless steel guide pins for blind mating applications. Use with guide bushing on mating connector.	 B Guide Bushing Non-removable, 300 series stainless steel female guide bushings for blind mating applications. Use with guide pin on mating connector.
--	--	--	---

Table 2 Arrangement Number

Change the "P" to a "W" in any combo arrangement to delete power contacts. For example, arrangement **H-10P4** is supplied with a total of 10 contacts including (4) #12 power pins and (6) signal pins. Arrangement **H-10W4** is supplied with (6) signal pins and no power pins. Order coax contacts separately.

Arrangements with Size #23 Contacts	Arrangements with Size #16 Contacts	Arrangements with Size #12 Contacts
 A-5 5 #23  B-9 9 #23  C-13 13 #23	 B-2P2 2 #16  D-3P3 3 #16  D-7P2 5 #23, 2 #16  E-11P2 9 #23, 2 #16  E-7P3 4 #23, 3 #16  F-14P3 11 #23, 3 #16  F-15P2 13 #23, 2 #16  F-5P5 5 #16  H-29P7 22 #23, 7 #16  H-54P2 52 #23, 2 #16  J-17P4 13 #23, 4 #16  J-25P2 23 #23, 2 #16  J-7P7 7 #16  K-27P4 23 #23, 4 #16  K-35P2 33 #23, 2 #16  K-9P9 9 #16  M-17P17 17 #16	 G-13P2 11 #23, 2 #12  G-3P3 3 #12  G-21P1 20 #23, 1 #12  H-10P4 6 #23, 4 #12  H-36P2 34 #23, 2 #12  H-5P5 5 #12  L-6P6 6 #12 Arrangements with Size #8 Contacts  M-4P4 Supplied with 4 #8 Power Contacts  M-4W4 Contacts ordered separately, dielectric insert  M-4G4 contacts ordered separately, metal insert

Panel Mount Connectors with Crimp-and-Poke Contacts

791-020S Panel Mount Plug Connectors with Socket Contacts

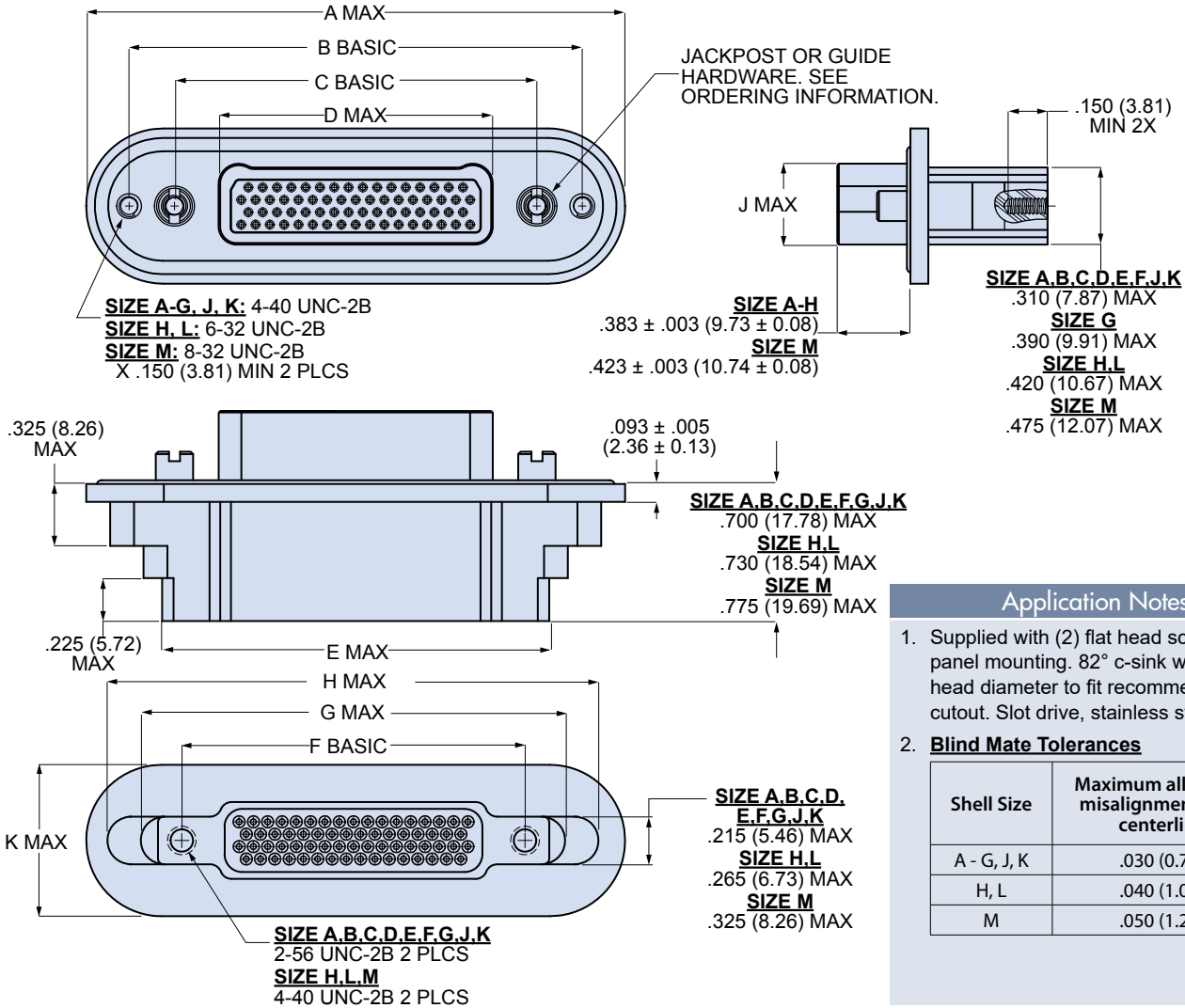

791-020S Dimensions

Shell Size	A Max		B Basic		C Basic		D Max		E Max		F Basic		G Max		H Max		J Max		K Max	
	In.	mm.	In.	mm.	In.	mm.	In.	mm.	In.	mm.	In.	mm.	In.	mm.	In.	mm.	In.	mm.	In.	mm.
A	1.565	39.75	1.150	29.21	.750	19.05	.410	10.41	.760	19.30	.565	14.35	.960	24.38	1.345	34.16	.320	8.13	.710	18.03
B	1.715	43.56	1.300	33.02	.900	22.86	.560	14.22	.910	21.11	.715	18.16	1.110	28.19	1.495	37.97	.320	8.13	.710	18.03
C	1.865	47.37	1.450	36.83	1.050	26.67	.710	18.03	1.060	26.92	.865	21.97	1.260	32.00	1.645	41.78	.320	8.13	.710	18.03
D	1.940	49.28	1.525	38.74	1.125	28.58	.785	19.94	1.160	29.46	.965	24.51	1.360	34.54	1.745	44.32	.320	8.13	.710	18.03
E	2.090	53.09	1.675	42.55	1.275	32.39	.935	23.75	1.310	33.27	1.115	28.32	1.510	38.35	1.895	48.13	.320	8.13	.710	18.03
F	2.240	56.90	1.825	46.36	1.425	36.20	1.085	27.56	1.460	37.08	1.265	32.13	1.660	42.16	2.045	51.94	.320	8.13	.710	18.03
G	2.200	55.88	1.785	45.34	1.388	35.26	1.047	26.59	1.410	35.81	1.215	30.86	1.633	41.48	1.983	50.37	.420	10.67	.800	20.32
H	2.835	72.01	2.375	60.34	1.900	48.26	1.437	36.50	2.045	51.94	1.800	45.72	2.240	56.90	2.590	65.79	.430	10.92	.820	20.83
J	2.615	66.42	2.200	55.88	1.800	45.72	1.460	37.08	1.810	45.97	1.615	41.02	2.010	51.05	2.395	60.83	.320	8.13	.710	18.03
K	2.990	75.95	2.575	65.41	2.175	55.25	1.835	46.61	2.210	56.13	2.015	51.18	2.410	61.21	2.795	70.99	.320	8.13	.710	18.03
L	3.075	78.11	2.611	66.32	2.136	54.25	1.673	42.49	2.281	57.93	2.036	51.71	2.476	62.89	2.826	71.78	.430	10.92	.820	20.83
M	3.333	84.58	2.824	71.73	2.200	55.88	1.734	44.04	2.445	62.10	2.200	55.88	2.650	67.31	3.090	78.49	.515	13.08	.925	23.50

Panel Mount Connectors with Crimp-and-Poke Contacts

791-020S Panel Mount Plug Connectors with Socket Contacts

Recommended Panel Cutout

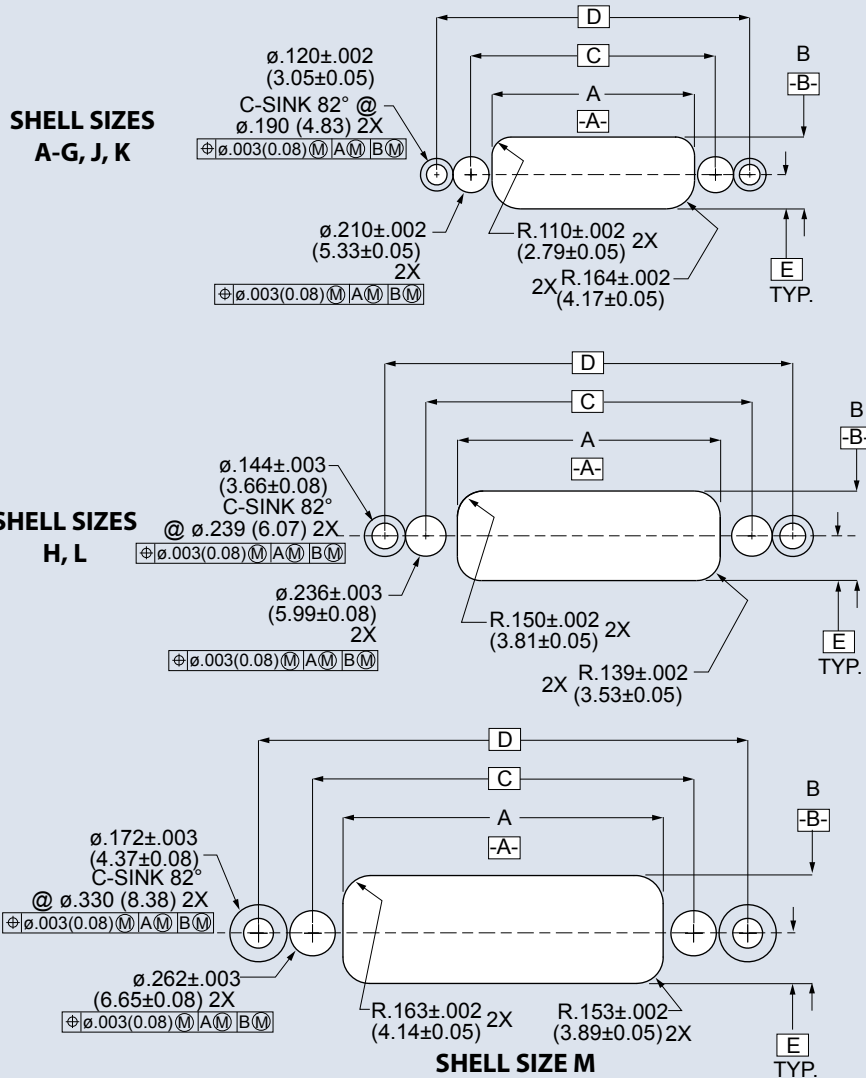

SHELL SIZE M

Shell Size	A ±.002(0.05)		B ±.002(0.05)		C Basic		D Basic		E Basic	
	In.	mm.	In.	mm.	In.	mm.	In.	mm.	In.	mm.
A	.505	12.83	.418	10.62	.750	19.50	1.150	29.21	.199	5.00
B	.655	16.64	.418	10.62	.900	22.86	1.300	33.02	.199	5.00
C	.805	20.45	.418	10.62	1.050	26.67	1.450	36.83	.199	5.00
D	.880	22.35	.418	10.62	1.125	28.58	1.525	38.74	.199	5.00
E	1.030	26.16	.418	10.62	1.275	32.39	1.675	42.55	.199	5.00
F	1.180	29.97	.418	10.62	1.425	36.20	1.825	46.36	.199	5.00
G	1.142	29.01	.506	12.85	1.388	35.25	1.786	45.34	.244	6.15
H	1.531	38.89	.521	13.23	1.900	48.26	2.375	60.34	.250	6.55
J	1.555	39.50	.418	10.62	1.800	45.72	2.200	55.88	.199	5.00
K	1.930	49.02	.418	10.62	2.175	55.25	2.575	65.41	.199	5.00
L	1.767	44.88	.521	13.23	2.136	54.26	2.611	66.32	.250	6.55
M	1.850	46.99	.623	15.82	2.200	55.88	2.824	71.73	.290	7.37

Crimp Tools

Contact Size	Crimper	Positioner	Die
23	809-015 (M22520/2-01)	809-005 (no mil spec #)	(not required)
16	809-136 (M22520/1-01)	809-137 (M22520/1-04)	(not required)
12	809-136 (M22520/1-01)	809-137 (M22520/1-04)	(not required)
8	859-025 (M22520/23-01)	859-046 (WA23-395L)	859-026 (M22520/23-02)

Note: see "Contacts and Tools" section for additional information

Insertion/Removal Tools

Contact Size	Insertion/Removal Tool
23	809-088 (no mil spec #)
16	809-131 (M81969/14-03)
12	809-132 (M81969/14-04)
8	859-049 (M81969/14-12)

Panel Mount Connectors with Crimp-and-Poke Contacts

791-019P Panel Mount Receptacle Connectors with Pin Contacts

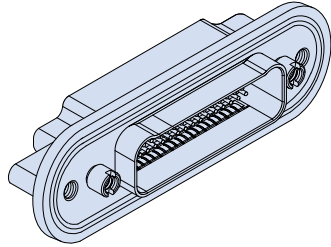

791-019P
Panel Mount Receptacle

RELIABLE DESIGN

- 100% scoop-proof
- Snap-in, rear release contacts
- EMI shell-to-shell continuity
- Blind mate capability

VERSATILE

- Wide range of configurations
- Signal, power, RF, datalink
- Rear panel mount

HARSH ENVIRONMENT

- Humidity, water ingress
- Shock and vibration
- Temperature extremes
- Corrosion resistance
- High altitude

SIZE AND WEIGHT SAVING

- High density

Harsh environment. Rugged construction. Ultraminiature. Series 791 connectors save size and weight compared to M24308 D Subminiature and other rack-and-panel connectors. Crimp, snap-in, rear release machined pin contacts. Aluminum shell, thermoplastic insulators and metal contact retention clips. Contacts are packaged with connector. Scoop-proof recessed pins for problem-free service, optional ground spring for improved EMI performance.

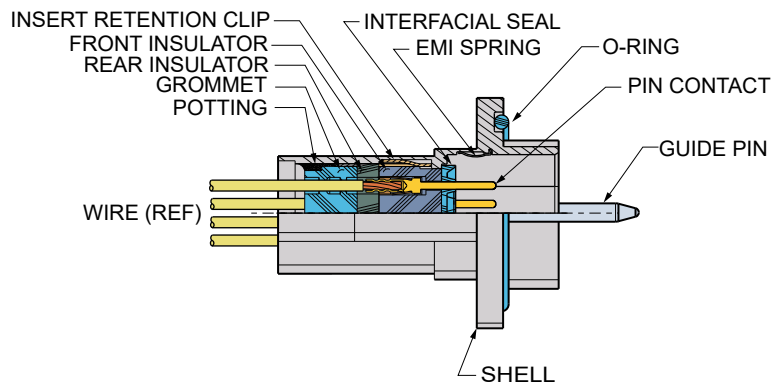

How To Order

Sample Part Number	791-019P	F-23	MT	E	B	F
Product	791-019P = Panel Mount Receptacle, Crimp, Pin Contacts					
Arrangement Number (Shell Size - Insert Arr.)	See Table 2					
Shell Finish	M = Electroless Nickel MT = Nickel-PTFE ZR = Black Zinc-Nickel					
EMI Spring	E = EMI spring N = No EMI spring					
Hardware Option (Table 1)	N = No hardware P = Jackpost G = Male guide pin B = Female guide bushing					
O-ring Option	N = No O-ring F = Fluorosilicone O-ring (non-conductive) C = Conductive fluorosilicone O-ring S = Metal EMI panel spring (non-environmental)					

Metal EMI Panel Spring

Gold-plated panel spring provides improved electrical bonding. Specify Code S.
Non-environmental.



Wire Accommodation

Contact Size	Wire Range AWG
23	22 – 28
16	16 – 20
12	12 – 14
8	8

Specifications

- Operating temperature: -65 to +150°C
- Current and voltage ratings:

Contact Size	Amps, max.	DWV Vac rms
23	5	750
16	13	1800
12	23	1800
8	46	1800
- Shock: EIA-364-27 condition D
- Vibration: EIA-364-28 condition V, letter E
- See pages 8-10 for additional information

Construction

- Shell: aluminum alloy
- Insulators: high grade rigid dielectric
- Grommet and interfacial seal: fluorosilicone blend
- Contacts: copper alloy, 50 microinches gold over nickel plating
- Encapsulant: epoxy
- O-ring: fluorosilicone
- Hardware: stainless steel, passivated
- O-ring code F fluorosilicone code C silver plated aluminum-filled fluorosilicone
- Metal EMI panel spring (code S): beryllium copper, gold plated

Panel Mount Connectors with Crimp-and-Poke Contacts

791-019P Panel Mount Receptacle Connectors with Pin Contacts

Table 1 Hardware Option











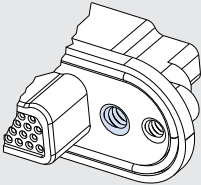
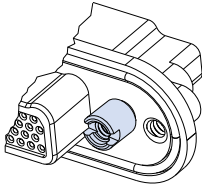
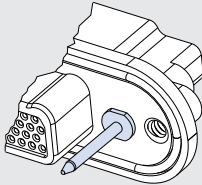
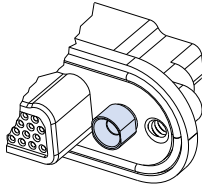





















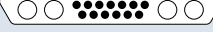



 N No Hardware Connector supplied with threaded holes, .150 (3.8) minimum depth. Shell sizes A-G, J, K have 6-32 UNC-2B thread, sizes H and L have 8-32 UNC-2B thread. Size M has 10-32 UNF-2B thread.	 P Jackposts Non-removable female jackpost. Shell sizes A-G, J, K have 4-40 UNC-2B thread, sizes H and L have 6-32 UNC-2B thread. Size M has 8-32 UNC-2B thread. 300 series stainless steel, passivated.	 G Guide Pins Non-removable, 300 series stainless steel guide pins for blind mating applications. Use with guide bushing on mating connector.	 B Guide Bushing Non-removable, 300 series stainless steel female guide bushings for blind mating applications. Use with guide pin on mating connector.
--	--	--	---

Table 2 Arrangement Number

Change the "P" to a "W" in any combo arrangement to delete power contacts. For example, arrangement **H-10P4** is supplied with a total of 10 contacts including (4) #12 power pins and (6) signal pins. Arrangement **H-10W4** is supplied with (6) signal pins and no power pins. Order coax contacts separately.

Arrangements with Size #23 Contacts	Arrangements with Size #16 Contacts	Arrangements with Size #12 Contacts
 A-5 5 #23  B-9 9 #23  C-13 13 #23  D-15 15 #23  E-19 19 #23  F-23 23 #23  G-33 33 #23  H-66 66 #23  J-33 33 #23  K-43 43 #23  L-78 78 #23  M-102 102 #23	 B-2P2 2 #16  D-3P3 3 #16  D-7P2 5 #23, 2 #16  E-11P2 9 #23, 2 #16  E-7P3 4 #23, 3 #16  F-14P3 11 #23, 3 #16  F-15P2 13 #23, 2 #16  F-5P5 5 #16  H-29P7 22 #23, 7 #16  H-54P2 52 #23, 2 #16  J-17P4 13 #23, 4 #16  J-25P2 23 #23, 2 #16  J-7P7 7 #16  K-27P4 23 #23, 4 #16  K-35P2 33 #23, 2 #16  K-9P9 9 #16  M-17P17 17 #16	 G-13P2 11 #23, 2 #12  G-3P3 3 #12  G-21P1 20 #23, 1 #12  H-10P4 6 #23, 4 #12  H-36P2 34 #23, 2 #12  H-5P5 5 #12  L-6P6 6 #12 Arrangements with Size #8 Contacts  M-4P4 Supplied with 4 #8 Power Contacts M-4W4 Contacts ordered separately, dielectric insert M-4G4 contacts ordered separately, metal insert

Panel Mount Connectors with Crimp-and-Poke Contacts

791-019P Panel Mount Receptacle Connectors with Pin Contacts

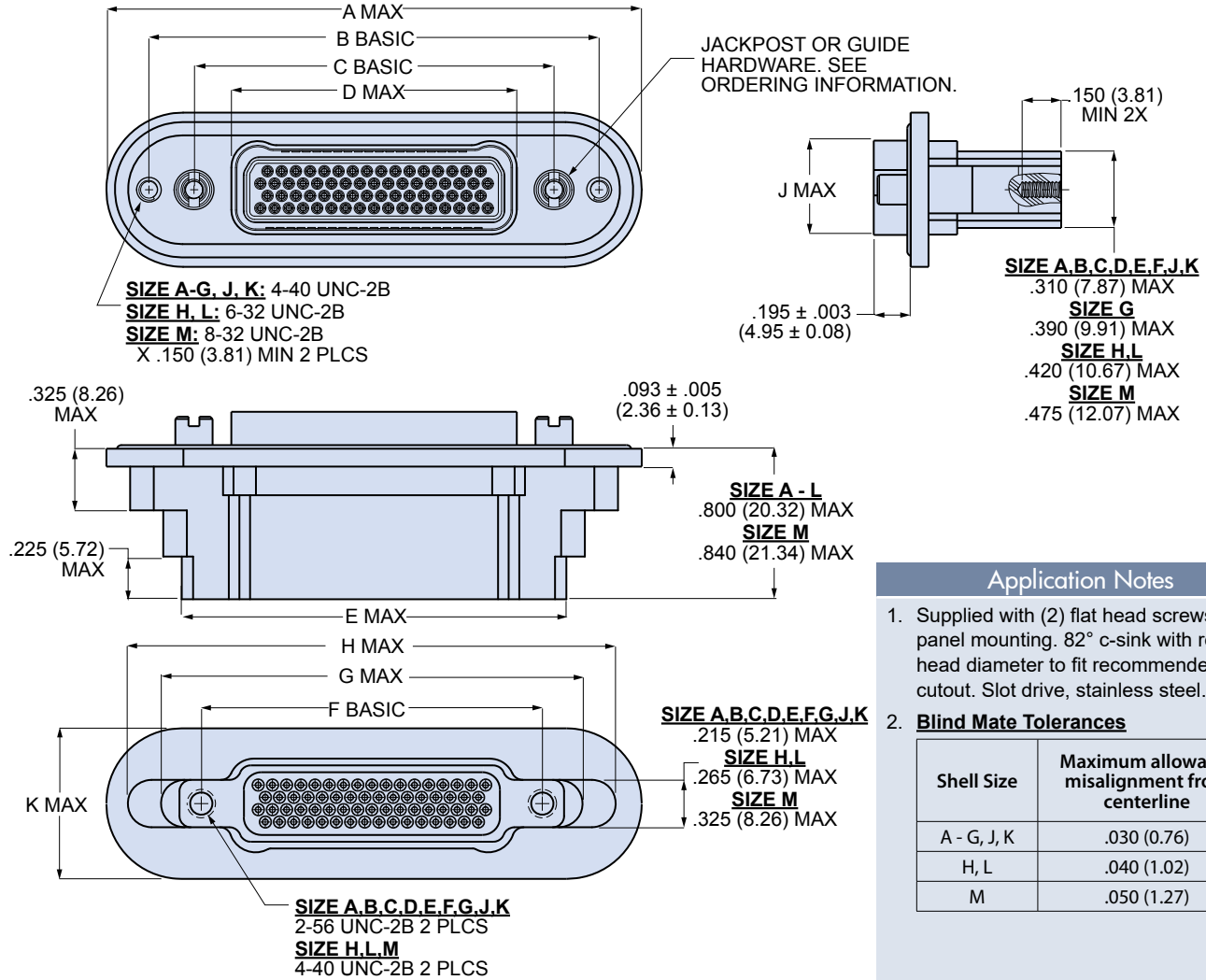

Application Notes

1. Supplied with (2) flat head screws for panel mounting. 82° c-sink with reduced head diameter to fit recommended panel cutout. Slot drive, stainless steel.
2. **Blind Mate Tolerances**

Shell Size	Maximum allowable misalignment from centerline
A - G, J, K	.030 (0.76)
H, L	.040 (1.02)
M	.050 (1.27)

791-019P Dimensions

Shell Size	A Max		B Basic		C Basic		D Max		E Max		F Basic		G Max		H Max		J Max		K Max	
	In.	mm.	In.	mm.	In.	mm.	In.	mm.	In.	mm.	In.	mm.	In.	mm.	In.	mm.	In.	mm.	In.	mm.
A	1.565	39.75	1.150	29.21	.750	19.05	.490	12.45	.760	19.30	.565	14.35	.960	24.38	1.345	34.16	.400	10.16	.710	18.03
B	1.715	43.56	1.300	33.02	.900	22.86	.630	16.00	.910	21.11	.715	18.16	1.110	28.19	1.495	37.97	.400	10.16	.710	18.03
C	1.865	55.34	1.450	36.83	1.050	26.67	.780	19.81	1.060	26.92	.865	21.97	1.260	32.00	1.645	41.78	.400	10.16	.710	18.03
D	1.940	49.28	1.525	38.74	1.125	28.58	.855	21.72	1.160	29.46	.965	24.51	1.360	34.54	1.745	44.32	.400	10.16	.710	18.03
E	2.090	53.09	1.675	42.55	1.275	32.38	1.005	25.53	1.310	33.27	1.115	28.32	1.510	38.35	1.895	48.13	.400	10.16	.710	18.03
F	2.240	56.60	1.825	46.36	1.425	36.20	1.155	29.34	1.460	37.08	1.265	32.13	1.660	42.16	2.045	51.94	.400	10.16	.710	18.03
G	2.200	55.88	1.785	45.34	1.388	35.26	1.117	28.37	1.410	35.81	1.215	30.86	1.633	41.48	1.983	50.37	.490	12.45	.800	20.32
H	2.835	72.01	2.375	60.34	1.900	48.26	1.507	38.28	2.045	51.94	1.800	45.72	2.240	56.90	2.590	65.79	.510	12.95	.820	20.83
J	2.615	66.42	2.200	55.88	1.800	45.72	1.530	38.86	1.810	45.97	1.615	41.02	2.010	51.05	2.395	60.83	.400	10.16	.710	18.03
K	2.990	75.95	2.575	65.41	2.175	55.25	1.905	48.39	2.210	56.13	2.015	51.18	2.410	61.21	2.795	70.99	.400	10.16	.710	18.03
L	3.075	78.11	2.611	66.32	2.136	54.26	1.743	44.27	2.281	57.93	2.036	51.71	2.476	62.89	2.826	71.78	.510	12.95	.820	20.83
M	3.340	84.96	2.824	71.73	2.200	55.88	1.804	45.82	2.445	62.10	2.200	55.88	2.650	67.31	3.090	78.49	.585	14.86	.925	23.50

Panel Mount Connectors with Crimp-and-Poke Contacts

791-019P Panel Mount Receptacle Connectors with Pin Contacts

Recommended Panel Cutout

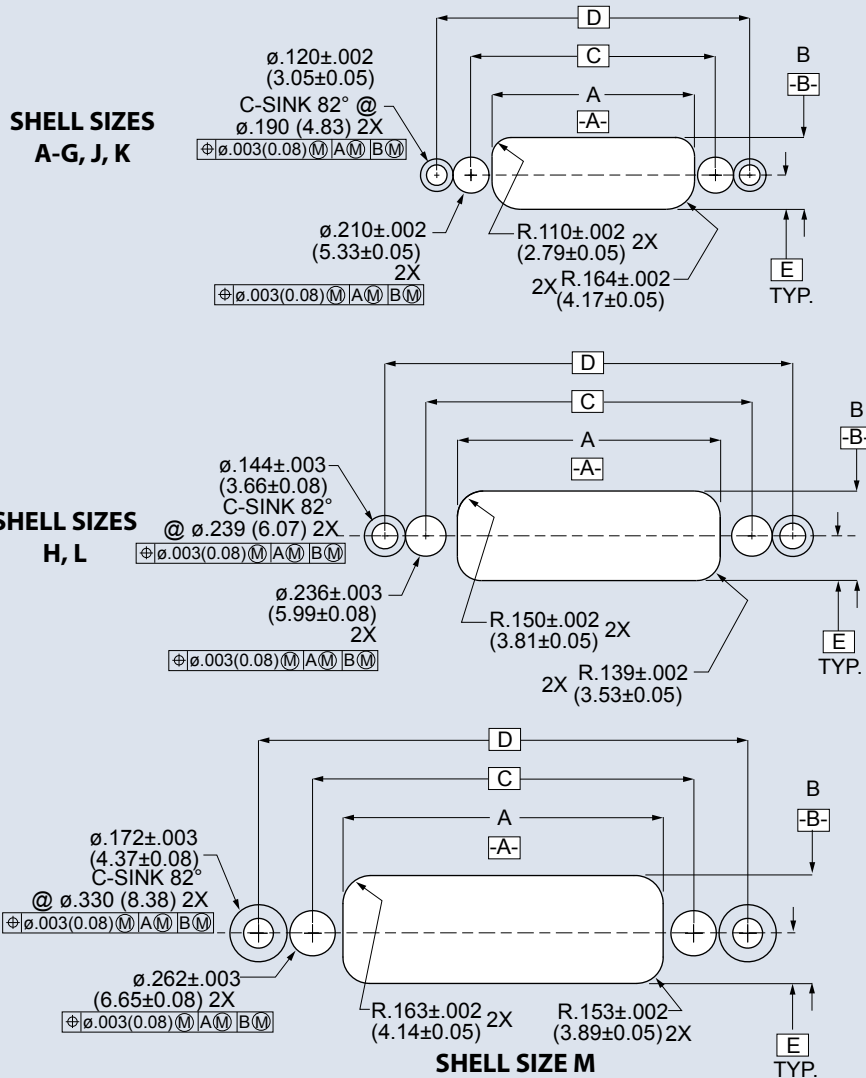

Shell Size	A ±.002(0.05)		B ±.002(0.05)		C Basic		D Basic		E Basic	
	In.	mm.	In.	mm.	In.	mm.	In.	mm.	In.	mm.
A	.505	12.83	.418	10.62	.750	19.50	1.150	29.21	.199	5.05
B	.655	16.64	.418	10.62	.900	22.86	1.300	33.02	.199	5.05
C	.805	20.45	.418	10.62	1.050	26.67	1.450	36.83	.199	5.05
D	.880	22.35	.418	10.62	1.125	28.58	1.525	38.74	.199	5.05
E	1.030	26.16	.418	10.62	1.275	32.39	1.675	42.55	.199	5.05
F	1.180	29.97	.418	10.62	1.425	36.20	1.825	46.36	.199	5.05
G	1.142	29.01	.506	12.85	1.388	35.25	1.786	45.34	.244	6.20
H	1.531	38.89	.521	13.23	1.900	48.26	2.375	60.34	.250	6.35
J	1.555	39.50	.418	10.62	1.800	45.72	2.200	55.88	.199	5.05
K	1.930	49.02	.418	10.62	2.175	55.25	2.575	65.41	.199	5.05
L	1.767	44.88	.521	13.23	2.136	54.26	2.611	66.32	.250	6.35
M	1.850	46.99	.623	15.82	2.200	55.88	2.824	71.73	.290	7.37

Crimp Tools

Contact Size	Crimper	Positioner	Die
23	809-015 (M22520/2-01)	809-005 (no mil spec #)	(not required)
16	809-136 (M22520/1-01)	809-137 (M22520/1-04)	(not required)
12	809-136 (M22520/1-01)	809-137 (M22520/1-04)	(not required)
8	859-025 (M22520/23-01)	859-046 (WA23-395L)	859-026 (M22520/23-02)

Note: see "Contacts and Tools" section for additional information

Insertion/Removal Tools

Contact Size	Insertion/Removal Tool
23	809-088 (no mil spec #)
16	809-131 (M81969/14-03)
12	809-132 (M81969/14-04)
8	859-049 (M81969/14-12)

Printed Circuit Board Connectors

791-014S Plug Connectors with Straight Tail PCB Socket Contacts

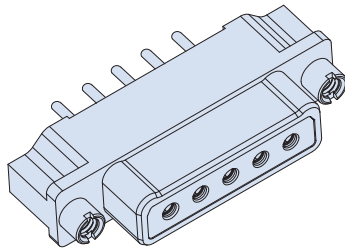

791-014S
PCB Plug

Harsh environment. Rugged construction. Ultraminature. Series 791 connectors are the next-generation higher density alternative to M24308 D Subminiature and other rack-and-panel connectors. Dual lobe shell, mating receptacle has recessed pins to prevent scooping damage. Epoxy-sealed terminals. Aluminum shell, thermoplastic insulator, gold-plated copper alloy contacts, stainless steel jackposts. Integral board standoffs, threaded board mount holes. 5A to 46A current rating depending on contact size.

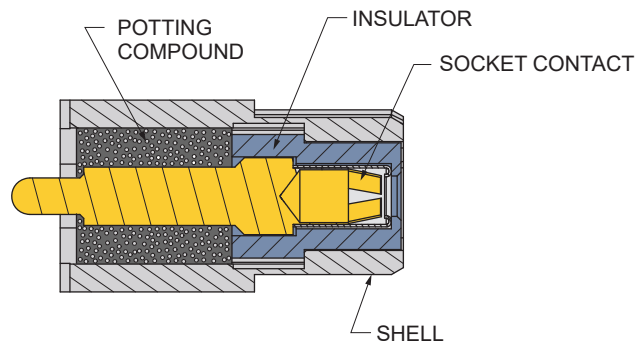

RELIABLE DESIGN

- 100% scoop-proof
- Sealed PC tail contacts
- EMI shell-to-shell continuity

VERSATILE

- Wide range of configurations
- #23, #16, #12 and #8 contacts
- Rear panel mount

HARSH ENVIRONMENT

- Humidity, water ingress
- Shock and vibration
- Temperature extremes
- Corrosion resistance
- High altitude

SIZE AND WEIGHT SAVING

- High density

How To Order

Sample Part Number	791-014S	G-33	M	P	B
Product	791-014S = Plug connector, straight PC tail				
Arrangement Number (Shell Size - Insert Arr.)	See Table 2				
Shell Finish	M = Electroless Nickel MT = Nickel-PTFE ZR = Black Zinc-Nickel				
Hardware Option (Table 1)	N = No jackpost P = Jackpost R1 = Rear panel jackpost, .032 (0.81) panel R2 = Rear panel jackpost, .050 (1.27) panel R3 = Rear panel jackpost, .062 (1.59) panel R4 = Rear panel jackpost, .080 (2.03) panel R5 = Rear panel jackpost, .093 (2.36) panel R6 = Rear panel jackpost, .125 (3.18) panel				
PC Tail Length	A = .125 inch (3.18) B = .250 inch (6.35) C = .375 inch (9.53)				

Specifications

- Operating temperature: -65 to +150°C
- Current and voltage ratings:

Contact Size	Amps, max.	DWV Vac rms
23	5	750
16	13	1800
12	23	1800
8	46	1800
- Shock: EIA-364-27 condition D
- Vibration: EIA-364-28 condition V, letter E
- See pages 8-10 for additional information

Construction

- Shell: aluminum alloy
- Insulators: high grade rigid dielectric
- Contacts: copper alloy, 50 microinches gold over nickel plating
- Socket contact hood: stainless steel, passivated
- Encapsulant: epoxy
- Hardware: stainless steel, passivated

Printed Circuit Board Connectors

791-014S Plug Connectors with Straight Tail PCB Socket Contacts

Table 1 Hardware Option











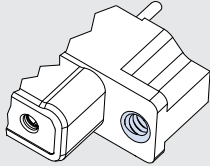
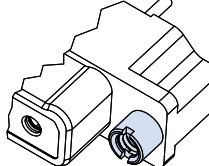
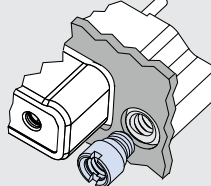





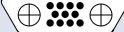



















 <p>N No Jackpost</p> <p>Connector supplied with threaded holes, .150 (3.8) minimum depth. Shell sizes A-G, J, K have 6-32 UNC-2B thread, sizes H and L have 8-32 UNC-2B thread. Size M has 10-32 UNF-2B thread.</p>	 <p>P Jackposts</p> <p>Non-removable female jackpost. Shell sizes A-G, J, K have 4-40 UNC-2B thread, sizes H and L have 6-32 UNC-2B thread. Size M has 8-32 UNC-2B thread. 300 series stainless steel, passivated.</p>	 <p>R1 - R6 Rear Panel Jackposts</p> <p>For rear panel mounting of connector onto .032 - .125 inch (0.81 - 3.18) thick panels. Install with Loctite #272 threadlocking compound. Shell sizes A-G, J, K have 4-40 UNC-2B thread, sizes H and L have 6-32 UNC-2B thread. Size M has 8-32 UNC-2B thread. 300 series stainless steel, passivated. Supplied loosely assembled.</p>
---	---	--

Table 2 Arrangement Number

Arrangements with Size #23 Contacts	Arrangements with Size #16 Contacts	Arrangements with Size #12 Contacts
 A-5 5 #23  B-9 9 #23  C-13 13 #23	 B-2P2 2 #16  D-3P3 3 #16  D-7P2 5 #23, 2 #16	 G-13P2 11 #23, 2 #12  G-3P3 3 #12  G-21P1 20 #23, 1 #12
 D-15 15 #23  E-19 19 #23	 E-11P2 9 #23, 2 #16  E-7P3 4 #23, 3 #16  F-14P3 11 #23, 3 #16	 H-10P4 6 #23, 4 #12  H-36P2 34 #23, 2 #12
 F-23 23 #23  G-33 33 #23	 F-15P2 13 #23, 2 #16  F-5P5 5 #16	 H-5P5 5 #12
 H-66 66 #23  J-33 33 #23	 H-29P7 22 #23, 7 #16  H-54P2 52 #23, 2 #16	 L-6P6 6 #12
 K-43 43 #23	 J-17P4 13 #23, 4 #16  J-25P2 23 #23, 2 #16	<p>Arrangements with Size #8 Contacts</p>  M-4P4
 L-78 78 #23	 J-7P7 7 #16  K-27P4 23 #23, 4 #16	
 M-102 102 #23	 K-35P2 33 #23, 2 #16  K-9P9 9 #16  M-17P17 17 #16	

Printed Circuit Board Connectors

791-014S Plug Connectors with Straight Tail PCB Socket Contacts

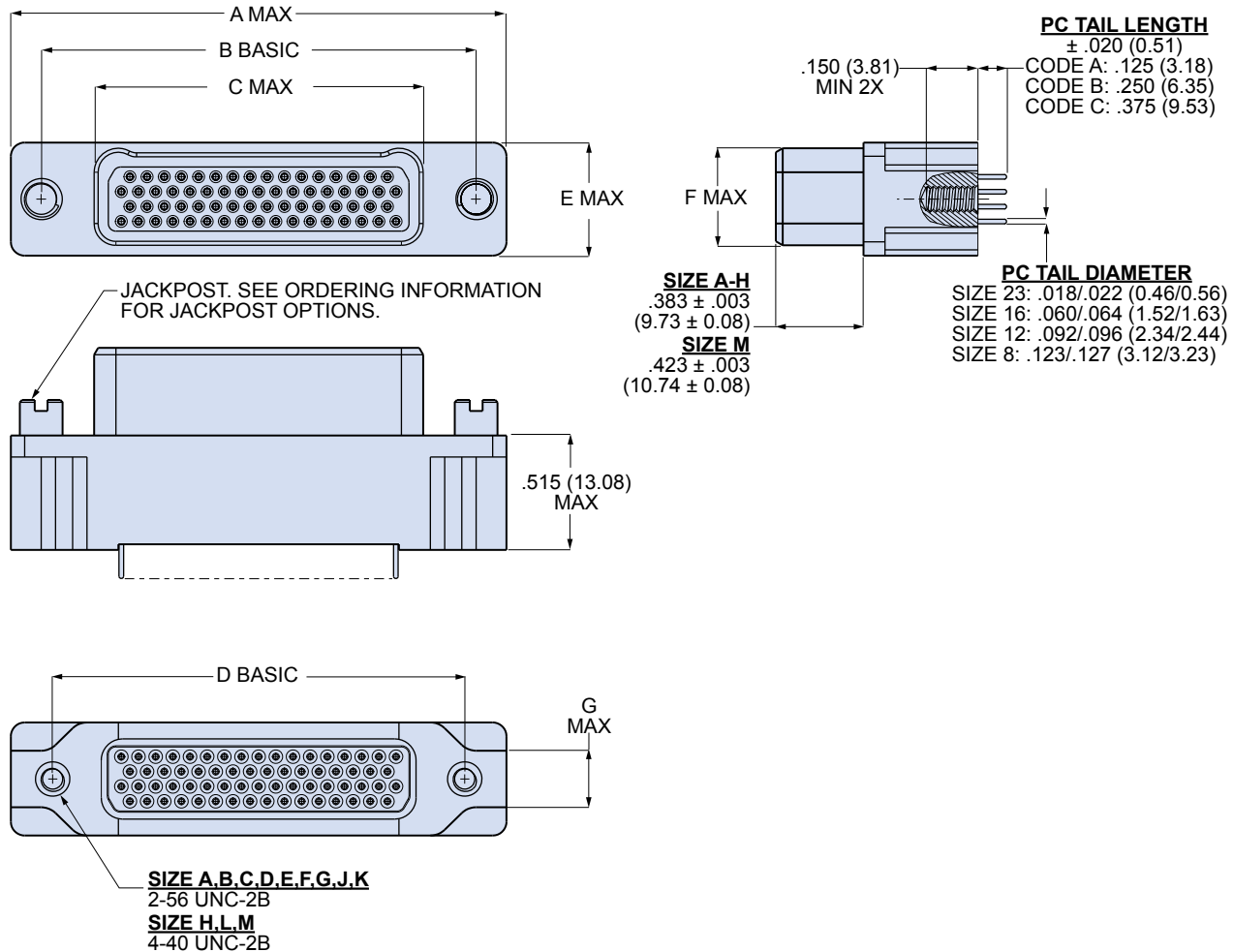

791-014S Dimensions

Shell Size	A Max		B Basic		C Max		D Basic		E Max		F Max		G Max	
	In.	mm.	In.	mm.	In.	mm.	In.	mm.	In.	mm.	In.	mm.	In.	mm.
A	.995	25.27	.750	19.05	.410	10.41	.565	14.35	.403	10.24	.320	8.13	.215	5.46
B	1.145	29.08	.900	22.86	.560	14.22	.715	18.16	.403	10.24	.320	8.13	.215	5.46
C	1.295	32.89	1.050	26.67	.710	18.03	.865	21.97	.403	10.24	.320	8.13	.215	5.46
D	1.370	34.80	1.125	28.58	.785	19.94	.965	24.51	.403	10.24	.320	8.13	.215	5.46
E	1.520	38.61	1.275	32.39	.935	23.75	1.115	28.31	.403	10.24	.320	8.13	.215	5.46
F	1.670	42.42	1.425	36.20	1.085	27.56	1.265	32.13	.403	10.24	.320	8.13	.215	5.46
G	1.630	41.40	1.388	35.26	1.047	26.59	1.215	30.86	.491	12.47	.420	10.67	.215	5.46
H	2.180	55.37	1.900	48.26	1.437	36.50	1.800	45.72	.509	12.93	.430	10.92	.265	6.73
J	2.045	51.94	1.800	45.72	1.460	37.08	1.615	41.02	.403	10.24	.320	8.13	.215	5.46
K	2.420	61.47	2.175	55.25	1.835	46.61	2.015	51.18	.403	10.24	.320	8.13	.215	5.46
L	2.416	61.37	2.136	54.25	1.673	42.49	2.036	51.71	.509	12.93	.430	10.92	.265	6.73
M	2.580	65.53	2.200	55.88	1.734	44.04	2.200	55.88	.577	14.66	.515	13.08	.275	6.99

Printed Circuit Board Connectors

791-014S Plug Connectors with Straight Tail PCB Socket Contacts

R1 – R6 Rear Panel Jackpost

SIZE A-G, J, K
.250 (6.35)
SIZE H, L
.325 (8.26)
SIZE M
.360 (9.14)

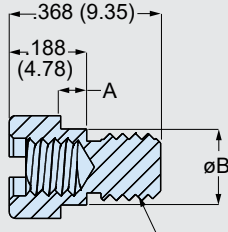
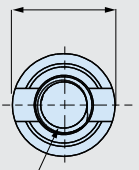

THREAD
SIZE A-G, J, K
4-40 UNC-2B
SIZE H, L
6-32 UNC-2B
SIZE M
8-32 UNC-2B

THREAD
SIZE A-G, J, K
6-32 UNC-2B
SIZE H, L
8-32 UNC-2B
SIZE M
10-32 UNF-2B

Code	A ± .003 (0.08)		øB
	In.	mm.	
R1	.032	0.81	Size A-G, J, K
R2	.050	1.27	.200 (5.08)
R3	.062	1.59	Size H
R4	.080	2.03	.226 (5.74)
R5	.093	2.36	Size M
R6	.125	3.18	.252 (6.40)

Recommended Panel Cutout for R1 – R6 Rear Panel Mount Jackposts

SHELL SIZES A-G, J, K

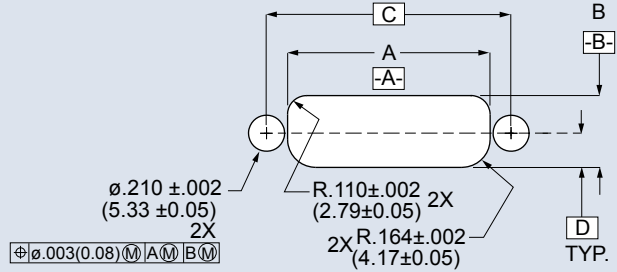

SHELL SIZES H, L

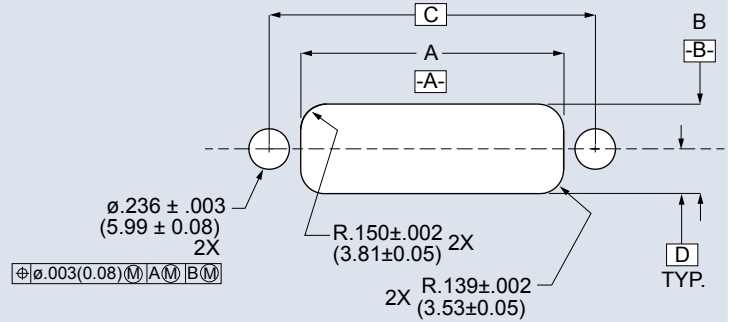

SHELL SIZE M

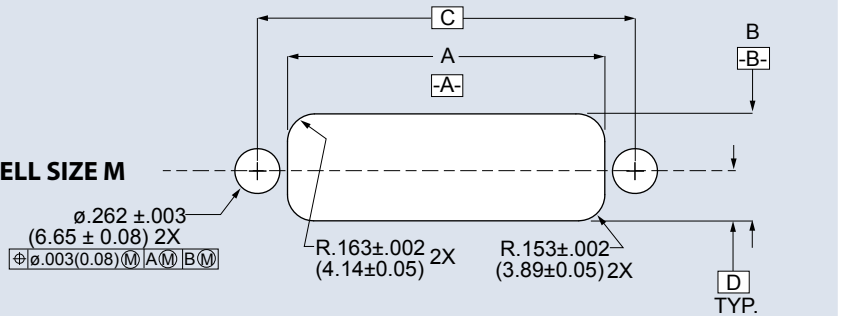

Shell Size	A ±.002(0.05)		B ±.002(0.05)		C Basic		D Basic	
	In.	mm.	In.	mm.	In.	mm.	In.	mm.
A	.505	12.83	.418	10.62	.750	19.50	.199	5.05
B	.655	16.64	.418	10.62	.900	22.86	.199	5.05
C	.805	20.45	.418	10.62	1.050	26.67	.199	5.05
D	.880	22.35	.418	10.62	1.125	28.58	.199	5.05
E	1.030	26.16	.418	10.62	1.275	32.39	.199	5.05
F	1.180	29.97	.418	10.62	1.425	36.20	.199	5.05
G	1.142	29.01	.506	12.85	1.388	35.25	.244	6.20
H	1.531	38.89	.521	13.23	1.900	48.26	.250	6.35
J	1.555	39.50	.418	10.62	1.800	45.72	.199	5.05
K	1.930	49.02	.418	10.62	2.175	55.25	.199	5.05
L	1.767	44.88	.521	13.23	2.136	54.26	.250	6.35
M	1.850	46.99	.623	15.82	2.200	55.88	.290	7.37

Printed Circuit Board Connectors

791-013P Receptacle Connectors with Straight Tail PCB Pin Contacts

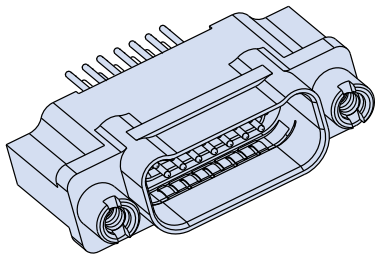

791-013P
PCB Receptacle

Harsh environment. Rugged construction. Ultraminiature. Series 791 connectors are the next-generation higher density alternative to M24308 D Subminiature and other rack-and panel connectors. Dual lobe shell, recessed pins to prevent scooping damage. Epoxy-sealed terminals. Aluminum shell, thermoplastic insulator, fluorosilicone face seal, gold-plated copper alloy contacts, stainless steel jackposts. Integral board standoffs, threaded board mount holes. 5A to 46A current rating depending on contact size.

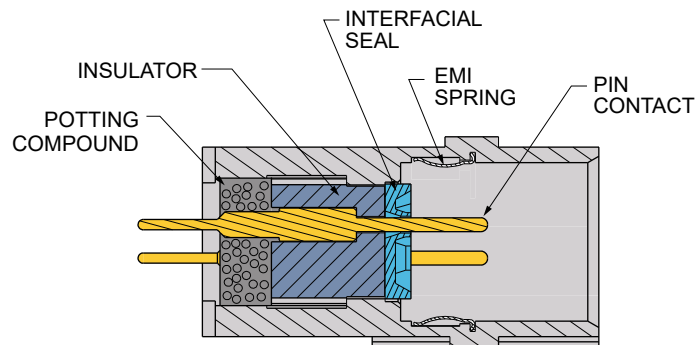

RELIABLE DESIGN

- 100% scoop-proof
- Sealed PC tail contacts
- EMI shell-to-shell continuity

VERSATILE

- Wide range of configurations
- #23, #16, #12 and #8 contacts
- Rear panel mount

HARSH ENVIRONMENT

- Humidity, water ingress
- Shock and vibration
- Temperature extremes
- Corrosion resistance
- High altitude

SIZE AND WEIGHT SAVING

- High density

How To Order

Sample Part Number	791-013P	K-43	MT	E	R1	A
Product	791-013P = Receptacle connector, straight PC tail, pin contacts					
Arrangement Number (Shell Size - Insert Arr.)	See Table 2					
Shell Finish	M = Electroless Nickel MT = Nickel-PTFE ZR = Black Zinc-Nickel					
EMI Spring	E = EMI spring N = No EMI spring					
Hardware Option (Table 1)	N = No jackposts P = Jackposts R1 = Rear panel jackposts, .032 (0.81) panel R2 = Rear panel jackposts, .050 (1.27) panel R3 = Rear panel jackposts, .062 (1.59) panel R4 = Rear panel jackposts, .080 (2.03) panel R5 = Rear panel jackposts, .093 (2.36) panel R6 = Rear panel jackposts, .125 (3.18) panel					
PC Tail Length	A = .125 inch (3.18) B = .250 inch (6.35) C = .375 inch (9.53)					

Specifications

- Operating temperature: -65 to +150°C
- Current and voltage ratings:

Contact Size	Amps, max.	DWV Vac rms
23	5	750
16	13	1800
12	23	1800
8	46	1800
- Shock: EIA-364-27 condition D
- Vibration: EIA-364-28 condition V, letter E
- See pages 8-10 for additional information

Construction

- Shell: aluminum alloy
- Insulators: high grade rigid dielectric
- Contacts: copper alloy, 50 microinches gold over nickel plating
- Interfacial Seal: fluorosilicone blend
- EMI spring: beryllium copper, nickel plated
- Hardware: 300 series stainless steel, passivated

Printed Circuit Board Connectors

791-013P Receptacle Connectors with Straight Tail PCB Pin Contacts

Table 1 Hardware Option











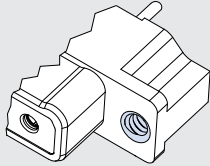
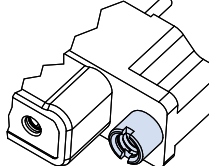
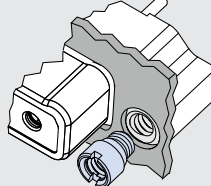





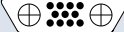



















 <p>N No Jackpost</p> <p>Connector supplied with threaded holes, .150 (3.8) minimum depth. Shell sizes A-G, J, K have 6-32 UNC-2B thread, sizes H and L have 8-32 UNC-2B thread. Size M has 10-32 UNF-2B thread.</p>	 <p>P Jackposts</p> <p>Non-removable female jackpost. Shell sizes A-G, J, K have 4-40 UNC-2B thread, sizes H and L have 6-32 UNC-2B thread. Size M has 8-32 UNC-2B thread. 300 series stainless steel, passivated.</p>	 <p>R1 - R6 Rear Panel Jackposts</p> <p>For rear panel mounting of connector onto .032 - .125 inch (0.81 - 3.18) thick panels. Install with Loctite #272 threadlocking compound. Shell sizes A-G, J, K have 4-40 UNC-2B thread, sizes H and L have 6-32 UNC-2B thread. Size M has 8-32 UNC-2B thread. 300 series stainless steel, passivated. Supplied loosely assembled.</p>
---	---	--

Table 2 Arrangement Number

Arrangements with Size #23 Contacts	Arrangements with Size #16 Contacts	Arrangements with Size #12 Contacts
 A-5 5 #23  B-9 9 #23  C-13 13 #23	 B-2P2 2 #16  D-3P3 3 #16  D-7P2 5 #23, 2 #16	 G-13P2 11 #23, 2 #12  G-3P3 3 #12  G-21P1 20 #23, 1 #12
 D-15 15 #23  E-19 19 #23	 E-11P2 9 #23, 2 #16  E-7P3 4 #23, 3 #16  F-14P3 11 #23, 3 #16	 H-10P4 6 #23, 4 #12  H-36P2 34 #23, 2 #12
 F-23 23 #23  G-33 33 #23	 F-15P2 13 #23, 2 #16  F-5P5 5 #16	 H-5P5 5 #12
 H-66 66 #23  J-33 33 #23	 H-29P7 22 #23, 7 #16  H-54P2 52 #23, 2 #16	 L-6P6 6 #12
 K-43 43 #23	 J-17P4 13 #23, 4 #16  J-25P2 23 #23, 2 #16	<p>Arrangements with Size #8 Contacts</p>  M-4P4
 L-78 78 #23	 J-7P7 7 #16  K-27P4 23 #23, 4 #16	
 M-102 102 #23	 K-35P2 33 #23, 2 #16  K-9P9 9 #16  M-17P17 17 #16	

Printed Circuit Board Connectors

791-013P Receptacle Connectors with Straight Tail PCB Pin Contacts

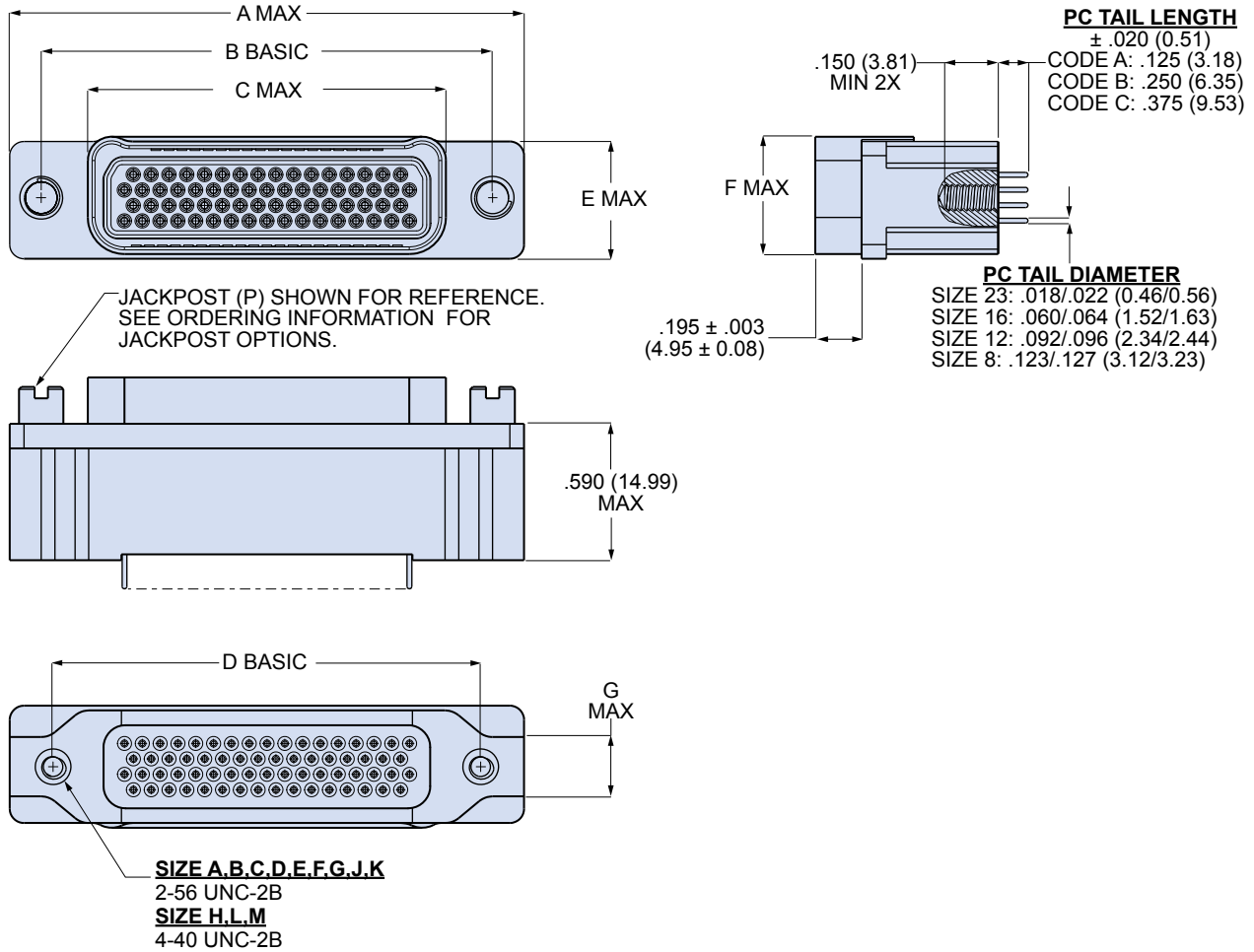

791-013P Dimensions

Shell Size	A Max		B Basic		C Max		D Basic		E Max		F Max		G Max	
	In.	mm.	In.	mm.	In.	mm.	In.	mm.	In.	mm.	In.	mm.	In.	mm.
A	.995	25.27	.750	19.05	.490	12.45	.565	14.35	.403	10.24	.400	10.16	.215	5.46
B	1.145	29.08	.900	22.86	.630	16.00	.715	18.16	.403	10.24	.400	10.16	.215	5.46
C	1.295	32.89	1.050	26.67	.780	19.81	.865	21.97	.403	10.24	.400	10.16	.215	5.46
D	1.370	34.80	1.125	28.58	.855	21.72	.965	24.51	.403	10.24	.400	10.16	.215	5.46
E	1.520	38.61	1.275	32.39	1.005	25.53	1.115	28.31	.403	10.24	.400	10.16	.215	5.46
F	1.670	42.42	1.425	36.20	1.155	29.34	1.265	32.13	.403	10.24	.400	10.16	.215	5.46
G	1.630	41.40	1.388	35.26	1.117	28.37	1.215	30.86	.491	12.47	.485	12.32	.215	5.46
H	2.180	55.37	1.900	48.26	1.507	38.28	1.800	45.72	.509	12.93	.500	12.70	.265	6.73
J	2.045	51.94	1.800	45.72	1.530	38.86	1.615	41.02	.403	10.24	.400	10.16	.215	5.46
K	2.420	61.47	2.175	55.25	1.905	48.39	2.015	51.18	.403	10.24	.400	10.16	.215	5.46
L	2.416	61.37	2.136	54.25	1.743	44.27	2.036	51.71	.509	12.93	.500	12.70	.265	6.73
M	2.580	65.53	2.200	55.88	1.804	45.82	2.200	55.88	.577	14.66	.585	14.86	.275	6.99

Printed Circuit Board Connectors

791-013P Receptacle Connectors with Straight Tail PCB Pin Contacts

R1 – R6 Rear Panel Jackpost

SIZE A-G, J, K
.250 (6.35)
SIZE H, L
.325 (8.26)
SIZE M
.360 (9.14)

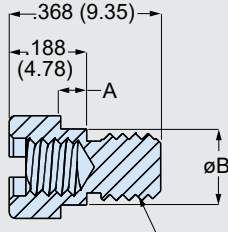
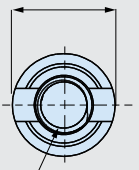

THREAD
SIZE A-G, J, K
4-40 UNC-2B
SIZE H, L
6-32 UNC-2B
SIZE M
8-32 UNC-2B

THREAD
SIZE A-G, J, K
6-32 UNC-2B
SIZE H, L
8-32 UNC-2B
SIZE M
10-32 UNF-2B

Code	A ± .003 (0.08)		øB
	In.	mm.	
R1	.032	0.81	Size A-G, J, K .200 (5.08)
R2	.050	1.27	Size H
R3	.062	1.59	Size M
R4	.080	2.03	.226 (5.74)
R5	.093	2.36	.252 (6.40)
R6	.125	3.18	

Recommended Panel Cutout for R1 – R6 Rear Panel Mount Jackposts

SHELL SIZES A-G, J, K

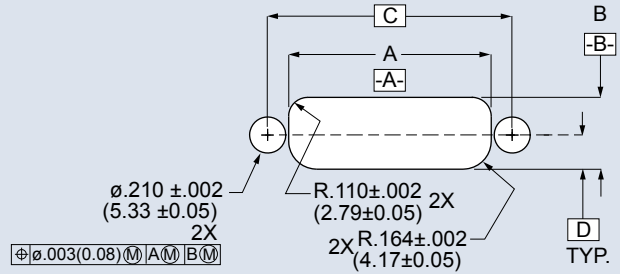

SHELL SIZES H, L

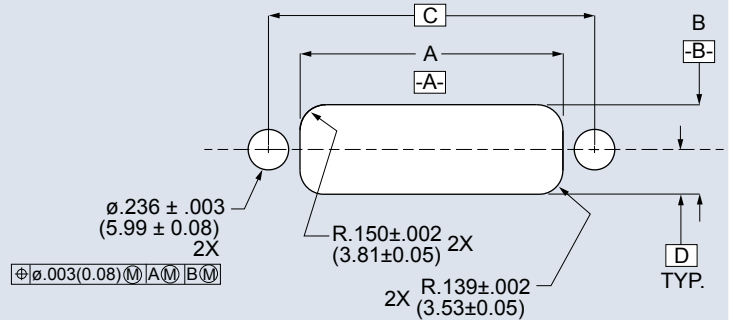

SHELL SIZE M

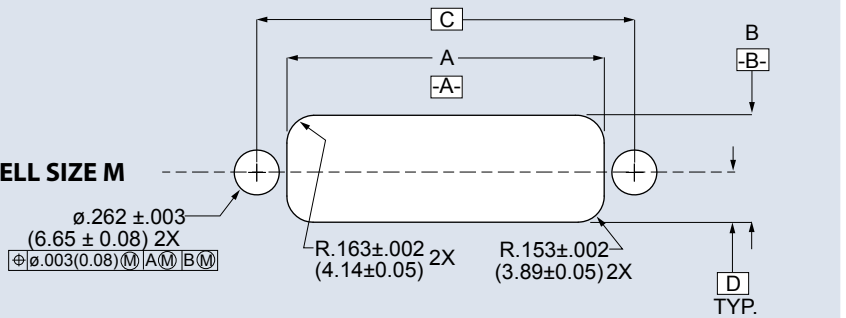

Shell Size	A ± .002(0.05)		B ± .002(0.05)		C Basic		D Basic	
	In.	mm.	In.	mm.	In.	mm.	In.	mm.
A	.505	12.83	.418	10.62	.750	19.50	.199	5.05
B	.655	16.64	.418	10.62	.900	22.86	.199	5.05
C	.805	20.45	.418	10.62	1.050	26.67	.199	5.05
D	.880	22.35	.418	10.62	1.125	28.58	.199	5.05
E	1.030	26.16	.418	10.62	1.275	32.39	.199	5.05
F	1.180	29.97	.418	10.62	1.425	36.20	.199	5.05
G	1.142	29.01	.506	12.85	1.388	35.25	.244	6.20
H	1.531	38.89	.521	13.23	1.900	48.26	.250	6.35
J	1.555	39.50	.418	10.62	1.800	45.72	.199	5.05
K	1.930	49.02	.418	10.62	2.175	55.25	.199	5.05
L	1.767	44.88	.521	13.23	2.136	54.26	.250	6.35
M	1.850	46.99	.623	15.82	2.200	55.88	.290	7.37

Printed Circuit Board Connectors

791-016S Plug Connectors with Right Angle PCB Socket Contacts

Harsh environment. Rugged construction. Ultraminiature. Series 791 connectors are the next-generation higher density alternative to M24308 D Subminiature and other rack-and-panel connectors. Dual lobe shell, mating receptacle has recessed pins to prevent scooping damage. Epoxy-sealed terminals. Aluminum shell, thermoplastic insulator, gold-plated copper alloy contacts, stainless steel jackposts. Integral board standoffs, threaded board mount holes. 5A to 46A current rating depending on contact size.

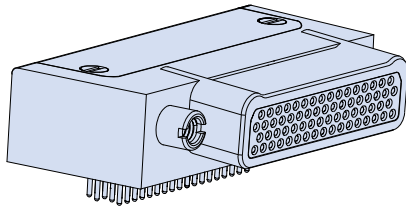

791-016S
PCB Plug

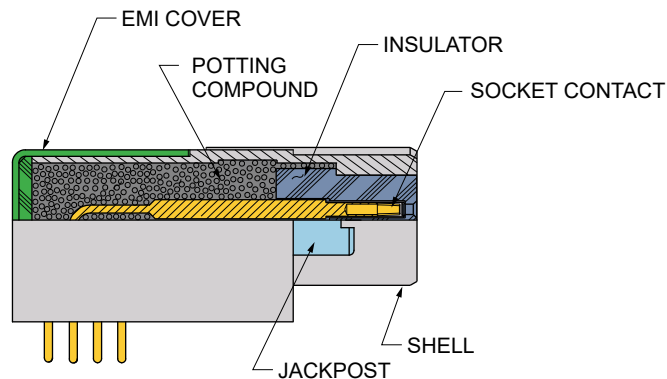

RELIABLE DESIGN

- 100% scoop-proof
- Sealed PC tail contacts
- EMI cover

VERSATILE

- Wide range of configurations
- #23, #16, #12 and #8 contacts
- Rear panel mount

HARSH ENVIRONMENT

- Humidity, water ingress
- Shock and vibration
- Temperature extremes
- Corrosion resistance
- High altitude

SIZE AND WEIGHT SAVING

- High density

How To Order

Sample Part Number	791-016S	L-6P6	MT	R3	A
Product	791-016S = Plug connector, right angle PC tail				
Arrangement Number (Shell Size - Insert Arr.)	See Table 2				
Shell Finish	M = Electroless Nickel MT = Nickel-PTFE ZR = Black Zinc-Nickel				
Hardware Option (Table 1)	N = No jackpost P = Jackpost R1 = Rear panel jackpost, .032 (0.81) panel R2 = Rear panel jackpost, .050 (1.27) panel R3 = Rear panel jackpost, .062 (1.59) panel R4 = Rear panel jackpost, .080 (2.03) panel R5 = Rear panel jackpost, .093 (2.36) panel R6 = Rear panel jackpost, .125 (3.18) panel				
PC Tail Length	A = .125 inch (3.18) B = .250 inch (6.35) C = .375 inch (9.53)				

Specifications

- Operating temperature: -65 to +150°C
- Current and voltage ratings:

Contact Size	Amps, max.	DWV Vac rms
23	5	750
16	13	1800
12	23	1800
8	46	1800
- Shock: EIA-364-27 condition D
- Vibration: EIA-364-28 condition V, letter E
- See pages 8-10 for additional information

Construction

- Shell: aluminum alloy
- Insulators: high grade rigid dielectric
- Contacts: copper alloy, 50 microinches gold over nickel plating
- Socket contact hood: stainless steel, passivated
- Encapsulant: epoxy
- EMI cover: aluminum, same finish as connector shell
- Hardware: stainless steel, passivated

Printed Circuit Board Connectors

791-016S Plug Connectors with Right Angle PCB Socket Contacts

Table 1 Hardware Option











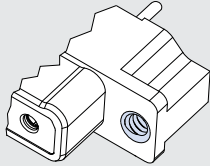
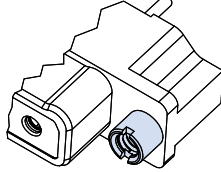
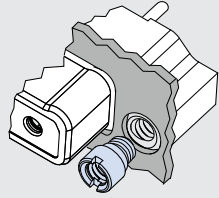





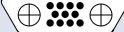



















 <p>N No Jackpost</p> <p>Connector supplied with threaded holes, .150 (3.8) minimum depth. Shell sizes A-G, J, K have 6-32 UNC-2B thread, sizes H and L have 8-32 UNC-2B thread. Size M has 10-32 UNF-2B thread.</p>	 <p>P Jackposts</p> <p>Non-removable female jackpost. Shell sizes A-G, J, K have 4-40 UNC-2B thread, sizes H and L have 6-32 UNC-2B thread. Size M has 8-32 UNC-2B thread. 300 series stainless steel, passivated.</p>	 <p>R1 - R6 Rear Panel Jackposts</p> <p>For rear panel mounting of connector onto .032 - .125 inch (0.81 - 3.18) thick panels. Install with Loctite #272 threadlocking compound. Shell sizes A-G, J, K have 4-40 UNC-2B thread, sizes H and L have 6-32 UNC-2B thread. Size M has 8-32 UNC-2B thread. 300 series stainless steel, passivated. Supplied loosely assembled.</p>
---	---	--

Table 2 Arrangement Number

Arrangements with Size #23 Contacts	Arrangements with Size #16 Contacts	Arrangements with Size #12 Contacts
 A-5 5 #23  B-9 9 #23  C-13 13 #23	 B-2P2 2 #16  D-3P3 3 #16  D-7P2 5 #23, 2 #16	 G-13P2 11 #23, 2 #12  G-3P3 3 #12  G-21P1 20 #23, 1 #12
 D-15 15 #23  E-19 19 #23	 E-11P2 9 #23, 2 #16  E-7P3 4 #23, 3 #16  F-14P3 11 #23, 3 #16	 H-10P4 6 #23, 4 #12  H-36P2 34 #23, 2 #12
 F-23 23 #23  G-33 33 #23	 F-15P2 13 #23, 2 #16  F-5P5 5 #16	 H-5P5 5 #12
 H-66 66 #23  J-33 33 #23	 H-29P7 22 #23, 7 #16  H-54P2 52 #23, 2 #16	 L-6P6 6 #12
 K-43 43 #23	 J-17P4 13 #23, 4 #16  J-25P2 23 #23, 2 #16	<p>Arrangements with Size #8 Contacts</p>  M-4P4
 L-78 78 #23	 J-7P7 7 #16  K-27P4 23 #23, 4 #16	
 M-102 102 #23	 K-35P2 33 #23, 2 #16  K-9P9 9 #16  M-17P17 17 #16	

Printed Circuit Board Connectors

791-016S Plug Connectors with Right Angle PCB Socket Contacts

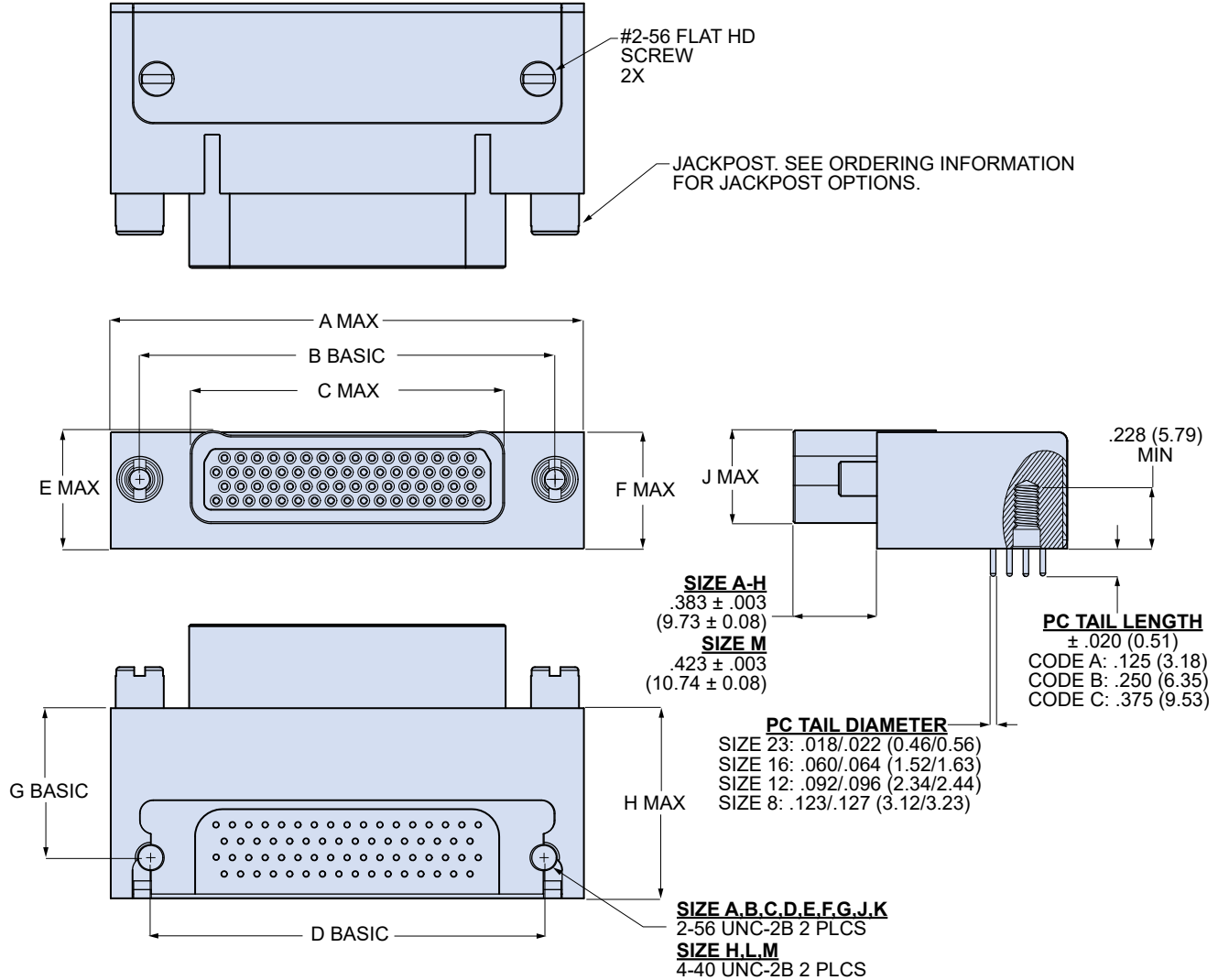

791-016S Dimensions

Shell Size	A Max		B Basic		C Max		D Basic		E Max		F Max		G Basic		H Max		J Max	
	In.	mm.	In.	mm.	In.	mm.	In.	mm.	In.	mm.	In.	mm.	In.	mm.	In.	mm.	In.	mm.
A	.995	25.27	.750	19.05	.410	10.41	.565	14.35	.435	11.05	.430	10.92	.610	15.49	.725	18.42	.320	8.13
B	1.145	29.08	.900	22.86	.560	14.22	.715	18.16	.435	11.05	.430	10.92	.610	15.49	.725	18.42	.320	8.13
C	1.295	32.89	1.050	26.67	.710	18.03	.865	21.97	.435	11.05	.430	10.92	.610	15.49	.725	18.42	.320	8.13
D	1.370	34.80	1.125	28.58	.785	19.94	.965	24.51	.435	11.05	.430	10.92	.610	15.49	.725	18.42	.320	8.13
E	1.520	38.61	1.275	32.38	.935	23.75	1.115	28.32	.435	11.05	.430	10.92	.610	15.49	.725	18.42	.320	8.13
F	1.670	42.42	1.425	36.20	1.085	27.56	1.265	32.13	.435	11.05	.430	10.92	.610	15.49	.725	18.42	.320	8.13
G	1.630	41.40	1.388	35.26	1.047	26.59	1.215	30.86	.525	13.34	.515	13.08	.682	17.37	.800	20.32	.420	10.67
H	2.180	55.37	1.900	48.26	1.437	36.50	1.800	45.72	.550	13.97	.540	13.72	.691	17.55	.880	22.35	.430	10.92
J	2.045	51.94	1.800	45.72	1.460	37.08	1.615	41.02	.435	11.05	.430	10.92	.610	15.49	.725	18.42	.320	8.13
K	2.420	61.47	2.175	55.25	1.835	46.61	2.015	51.18	.435	11.05	.430	10.92	.610	15.49	.725	18.42	.320	8.13
L	2.416	61.37	2.136	54.25	1.673	42.49	2.036	51.71	.550	13.97	.540	13.72	.691	17.55	.880	22.35	.430	10.92
M	2.580	65.53	2.200	55.88	1.734	44.04	2.200	55.88	.628	15.95	.600	15.24	.798	20.27	.995	25.27	.512	13.00

Printed Circuit Board Connectors

791-016S Plug Connectors with Right Angle PCB Socket Contacts

R1 – R6 Rear Panel Jackpost

SIZE A-G, J, K

.250 (6.35)

SIZE H, L

.325 (8.26)

SIZE M

.360 (9.14)

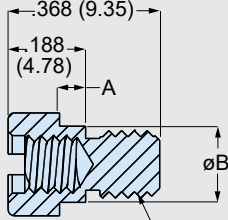
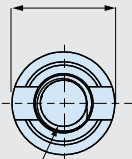

THREAD

SIZE A-G, J, K

4-40 UNC-2B

SIZE H, L

6-32 UNC-2B

SIZE M

8-32 UNC-2B

THREAD

SIZE A-G, J, K

6-32 UNC-2B

SIZE H, L

8-32 UNC-2B

SIZE M

10-32 UNF-2B

Code	A ± .003 (0.08)		øB
	In.	mm.	
R1	.032	0.81	Size A-G, J, K .200 (5.08)
R2	.050	1.27	Size H
R3	.062	1.59	Size M
R4	.080	2.03	.226 (5.74)
R5	.093	2.36	.252 (6.40)
R6	.125	3.18	

Recommended Panel Cutout for R1 – R6 Rear Panel Mount Jackposts

SHELL SIZES A-G, J, K

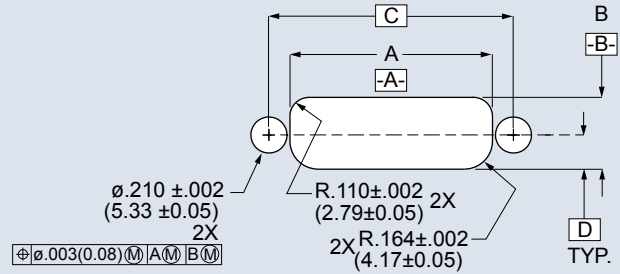

SHELL SIZES H, L

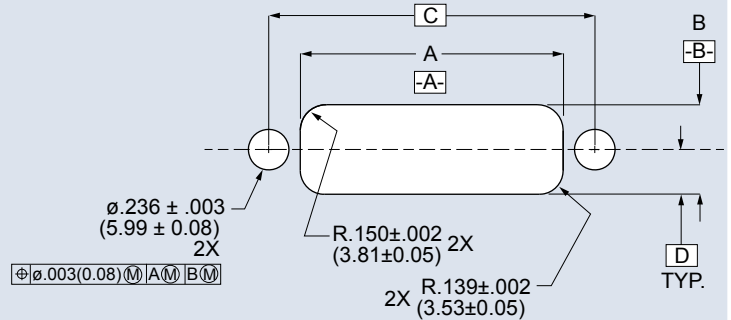

SHELL SIZE M

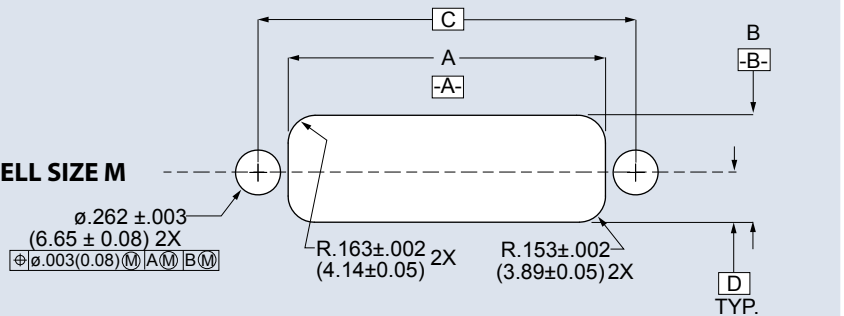

Shell Size	A ±.002(0.05)		B ±.002(0.05)		C Basic		D Basic	
	In.	mm.	In.	mm.	In.	mm.	In.	mm.
A	.505	12.83	.418	10.62	.750	19.50	.199	5.05
B	.655	16.64	.418	10.62	.900	22.86	.199	5.05
C	.805	20.45	.418	10.62	1.050	26.67	.199	5.05
D	.880	22.35	.418	10.62	1.125	28.58	.199	5.05
E	1.030	26.16	.418	10.62	1.275	32.39	.199	5.05
F	1.180	29.97	.418	10.62	1.425	36.20	.199	5.05
G	1.142	29.01	.506	12.85	1.388	35.25	.244	6.20
H	1.531	38.89	.521	13.23	1.900	48.26	.250	6.35
J	1.555	39.50	.418	10.62	1.800	45.72	.199	5.05
K	1.930	49.02	.418	10.62	2.175	55.25	.199	5.05
L	1.767	44.88	.521	13.23	2.136	54.26	.250	6.35
M	1.850	46.99	.623	15.82	2.200	55.88	.290	7.37

Printed Circuit Board Connectors

791-032P Receptacle Connectors with Right Angle PCB Pin Contacts

Harsh environment. Rugged construction. Ultraminiature. Series 791 connectors are the next-generation higher density alternative to M24308 D Subminiature and other rack-and panel connectors. Dual lobe shell, recessed pins to prevent scooping damage. Epoxy-sealed terminals. Aluminum shell, thermoplastic insulator, gold-plated copper alloy contacts, stainless steel jackposts. Integral board standoffs, threaded board mount holes. 5A to 46A current rating depending on contact size.

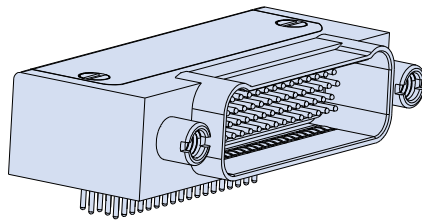

791-032P
PCB Receptacle

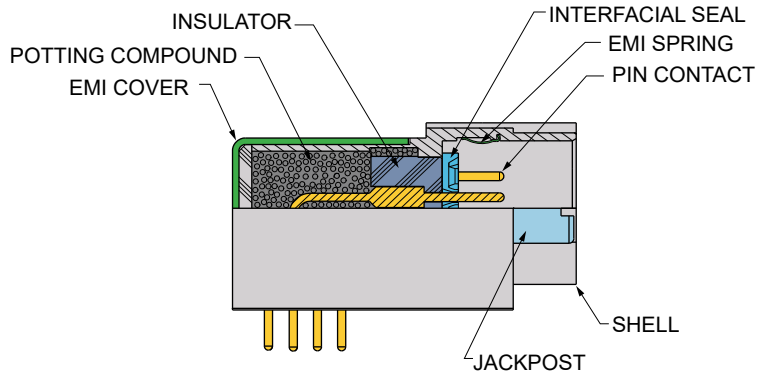

RELIABLE DESIGN

- 100% scoop-proof
- Sealed PC tail contacts
- EMI cover

VERSATILE

- Wide range of configurations
- #23, #16, #12 and #8 contacts
- Rear panel mount

HARSH ENVIRONMENT

- Humidity, water ingress
- Shock and vibration
- Temperature extremes
- Corrosion resistance
- High altitude

SIZE AND WEIGHT SAVING

- High density

How To Order

Sample Part Number	791-032P	H-66	M	N	P	B
Product	791-032P = Receptacle connector, right angle PC tail, pin contacts					
Arrangement Number (Shell Size - Insert Arr.)	See Table 2					
Shell Finish	M = Electroless Nickel MT = Nickel-PTFE ZR = Black Zinc-Nickel					
EMI Spring	E = EMI spring N = No EMI spring					
Hardware Option (Table 1)	N = No jackposts P = Jackposts R1 = Rear panel jackposts, .032 (0.81) panel R2 = Rear panel jackposts, .050 (1.27) panel R3 = Rear panel jackposts, .062 (1.59) panel R4 = Rear panel jackposts, .080 (2.03) panel R5 = Rear panel jackposts, .093 (2.36) panel R6 = Rear panel jackposts, .125 (3.18) panel					
PC Tail Length	A = .125 inch (3.18) B = .250 inch (6.35) C = .375 inch (9.53)					

Specifications

- Operating temperature: -65 to +150°C
- Current and voltage ratings:

Contact Size	Amps, max.	DWV Vac rms
23	5	750
16	13	1800
12	23	1800
8	46	1800

- See pages 8-10 for additional information

Construction

- Shell: aluminum alloy
- Insulators: high grade rigid dielectric
- Contacts: copper alloy, 50 microinches gold over nickel plating
- Interfacial Seal: fluorosilicone blend
- EMI spring: beryllium copper, nickel plated
- EMI cover: aluminum, same finish as shell
- Hardware: 300 series stainless steel, passivated

Printed Circuit Board Connectors

791-032P Receptacle Connectors with Right Angle PCB Pin Contacts

Table 1 Hardware Option











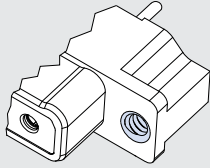
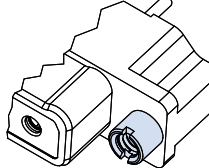
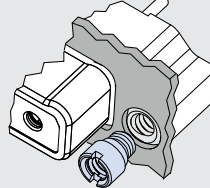





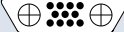











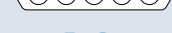







 <p>N No Jackpost</p> <p>Connector supplied with threaded holes, .150 (3.8) minimum depth. Shell sizes A-G, J, K have 6-32 UNC-2B thread, sizes H and L have 8-32 UNC-2B thread. Size M has 10-32 UNF-2B thread.</p>	 <p>P Jackposts</p> <p>Non-removable female jackpost. Shell sizes A-G, J, K have 4-40 UNC-2B thread, sizes H and L have 6-32 UNC-2B thread. Size M has 8-32 UNC-2B thread. 300 series stainless steel, passivated.</p>	 <p>R1 - R6 Rear Panel Jackposts</p> <p>For rear panel mounting of connector onto .032 - .125 inch (0.81 - 3.18) thick panels. Install with Loctite #272 threadlocking compound. Shell sizes A-G, J, K have 4-40 UNC-2B thread, sizes H and L have 6-32 UNC-2B thread. Size M has 8-32 UNC-2B thread. 300 series stainless steel, passivated. Supplied loosely assembled.</p>
---	---	--

Table 2 Arrangement Number

Arrangements with Size #23 Contacts	Arrangements with Size #16 Contacts	Arrangements with Size #12 Contacts
 A-5 5 #23  B-9 9 #23  C-13 13 #23	 B-2P2 2 #16  D-3P3 3 #16  D-7P2 5 #23, 2 #16	 G-13P2 11 #23, 2 #12  G-3P3 3 #12  G-21P1 20 #23, 1 #12
 D-15 15 #23  E-19 19 #23	 E-11P2 9 #23, 2 #16  E-7P3 4 #23, 3 #16  F-14P3 11 #23, 3 #16	 H-10P4 6 #23, 4 #12  H-36P2 34 #23, 2 #12
 F-23 23 #23  G-33 33 #23	 F-15P2 13 #23, 2 #16  F-5P5 5 #16	 H-5P5 5 #12
 H-66 66 #23  J-33 33 #23	 H-29P7 22 #23, 7 #16  H-54P2 52 #23, 2 #16	 L-6P6 6 #12
 K-43 43 #23	 J-17P4 13 #23, 4 #16  J-25P2 23 #23, 2 #16	<p>Arrangements with Size #8 Contacts</p>  M-4P4
 L-78 78 #23	 J-7P7 7 #16  K-27P4 23 #23, 4 #16	
 M-102 102 #23	 K-35P2 33 #23, 2 #16  K-9P9 9 #16  M-17P17 17 #16	

Printed Circuit Board Connectors

791-032P Receptacle Connectors with Right Angle PCB Pin Contacts

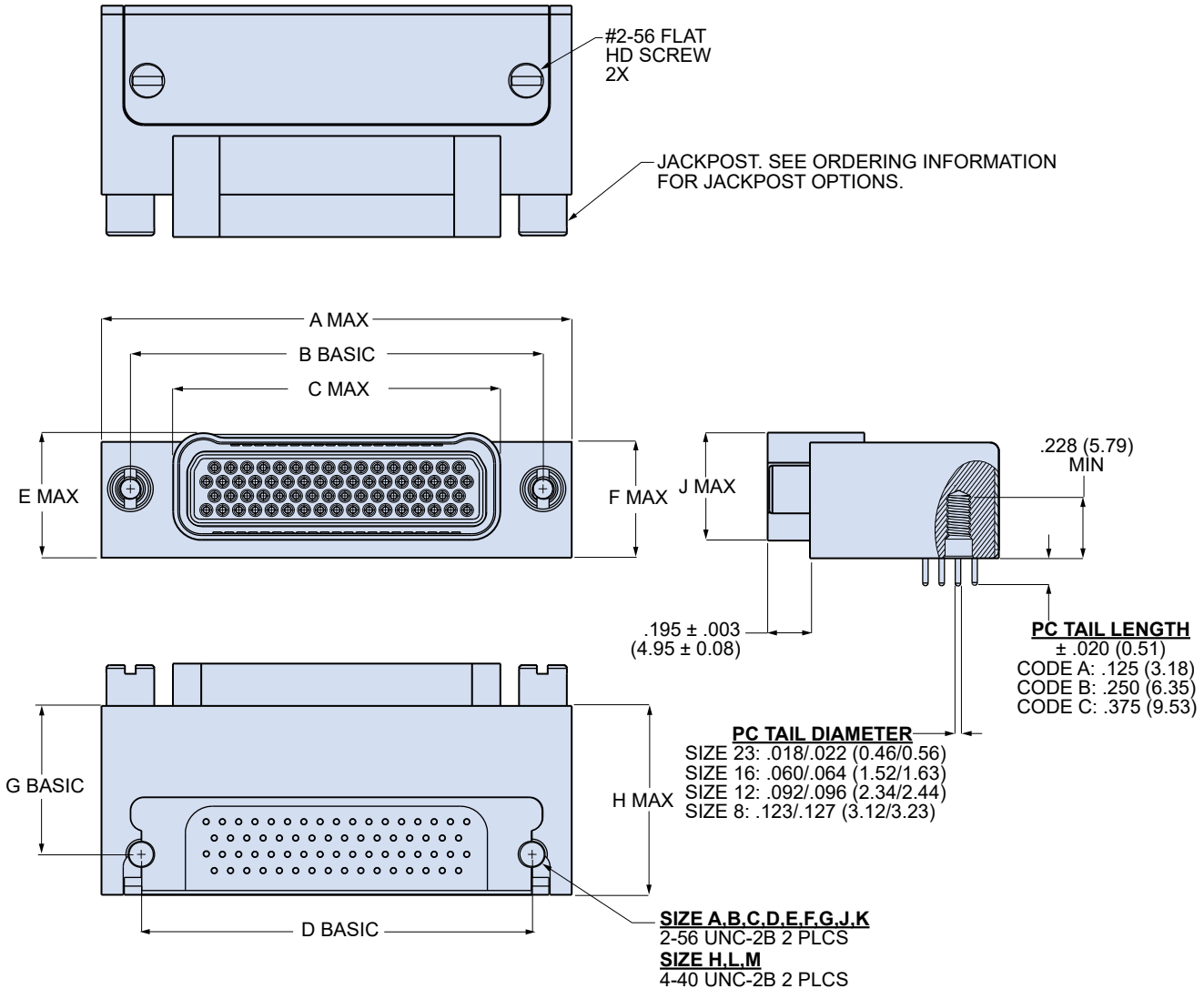

791-032P Dimensions

Shell Size	A Max		B Basic		C Max		D Basic		E Max		F Max		G Basic		H Max		J Max	
	In.	mm.	In.	mm.	In.	mm.	In.	mm.	In.	mm.	In.	mm.	In.	mm.	In.	mm.	In.	mm.
A	.995	25.27	.750	19.05	.490	12.45	.565	14.35	.475	12.07	.430	10.92	.610	15.49	.725	18.42	.400	10.16
B	1.145	29.08	.900	22.86	.630	16.00	.715	18.16	.475	12.07	.430	10.92	.610	15.49	.725	18.42	.400	10.16
C	1.295	32.89	1.050	26.67	.780	19.81	.865	21.97	.475	12.07	.430	10.92	.610	15.49	.725	18.42	.400	10.16
D	1.370	34.80	1.125	28.58	.855	21.72	.965	24.51	.475	12.07	.430	10.92	.610	15.49	.725	18.42	.400	10.16
E	1.520	38.61	1.275	32.38	1.005	25.53	1.115	28.32	.475	12.07	.430	10.92	.610	15.49	.725	18.42	.400	10.16
F	1.670	42.42	1.425	36.20	1.155	29.34	1.265	32.13	.475	12.07	.430	10.92	.610	15.49	.725	18.42	.400	10.16
G	1.630	41.40	1.388	35.26	1.117	28.37	1.215	30.86	.565	14.35	.515	13.08	.682	17.37	.800	20.32	.485	12.32
H	2.180	55.37	1.900	48.26	1.507	38.28	1.800	45.72	.590	14.99	.540	13.72	.691	17.55	.880	22.35	.500	12.93
J	2.045	51.94	1.800	45.72	1.530	38.86	1.615	41.02	.475	12.07	.430	10.92	.610	15.49	.725	18.42	.400	10.16
K	2.420	61.47	2.175	55.25	1.905	48.39	2.015	51.18	.475	12.07	.430	10.92	.610	15.49	.725	18.42	.400	10.16
L	2.416	61.37	2.136	54.25	1.743	44.27	2.036	51.71	.590	14.99	.540	13.72	.691	17.55	.880	22.35	.500	12.70
M	2.580	65.53	2.200	55.88	1.804	45.82	2.200	55.88	.635	16.13	.600	15.24	.798	20.26	.995	25.27	.585	14.86

Printed Circuit Board Connectors

791-032P Receptacle Connectors with Right Angle PCB Pin Contacts

R1 – R6 Rear Panel Jackpost

SIZE A-G, J, K

.250 (6.35)
SIZE H, L
 .325 (8.26)
SIZE M
 .360 (9.14)

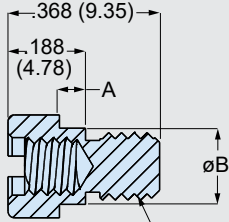
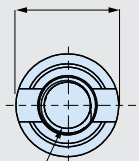

THREAD

SIZE A-G, J, K
 4-40 UNC-2B
SIZE H, L
 6-32 UNC-2B
SIZE M
 8-32 UNC-2B

THREAD

SIZE A-G, J, K
 6-32 UNC-2B
SIZE H, L
 8-32 UNC-2B
SIZE M
 10-32 UNF-2B

Code	A ± .003 (0.08)		øB
	In.	mm.	
R1	.032	0.81	Size A-G, J, K
R2	.050	1.27	.200 (5.08)
R3	.062	1.59	Size H
R4	.080	2.03	.226 (5.74)
R5	.093	2.36	Size M
R6	.125	3.18	.252 (6.40)

Recommended Panel Cutout for R1 – R6 Rear Panel Mount Jackposts

SHELL SIZES A-G, J, K

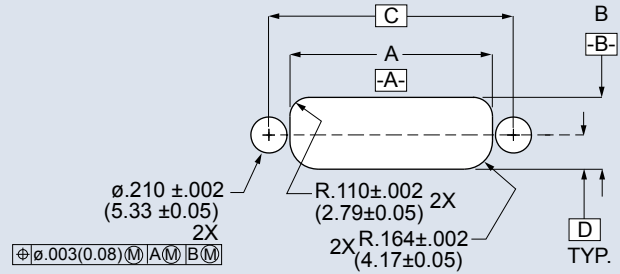

SHELL SIZES H, L

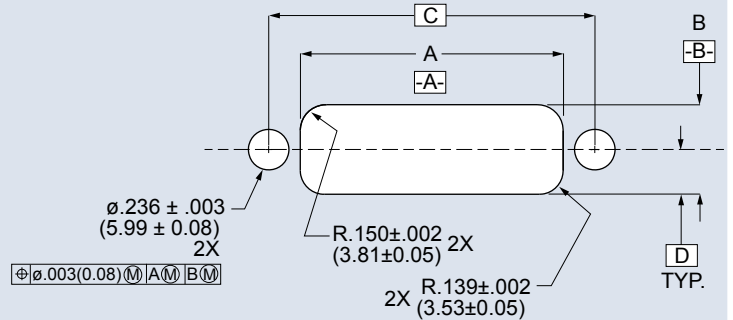

SHELL SIZE M

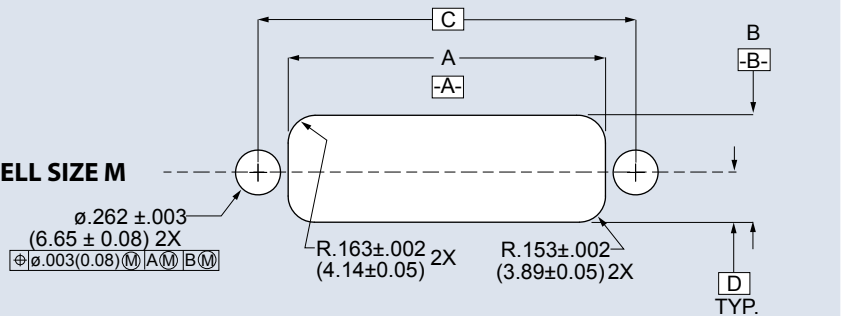

Shell Size	A ±.002(0.05)		B ±.002(0.05)		C Basic		D Basic	
	In.	mm.	In.	mm.	In.	mm.	In.	mm.
A	.505	12.83	.418	10.62	.750	19.50	.199	5.05
B	.655	16.64	.418	10.62	.900	22.86	.199	5.05
C	.805	20.45	.418	10.62	1.050	26.67	.199	5.05
D	.880	22.35	.418	10.62	1.125	28.58	.199	5.05
E	1.030	26.16	.418	10.62	1.275	32.39	.199	5.05
F	1.180	29.97	.418	10.62	1.425	36.20	.199	5.05
G	1.142	29.01	.506	12.85	1.388	35.25	.244	6.20
H	1.531	38.89	.521	13.23	1.900	48.26	.250	6.35
J	1.555	39.50	.418	10.62	1.800	45.72	.199	5.05
K	1.930	49.02	.418	10.62	2.175	55.25	.199	5.05
L	1.767	44.88	.521	13.23	2.136	54.26	.250	6.35
M	1.850	46.99	.623	15.82	2.200	55.88	.290	7.37

Panel Mount Printed Circuit Board Connectors

791-033S Panel Mount Plug Connectors with Straight PCB Socket Contacts

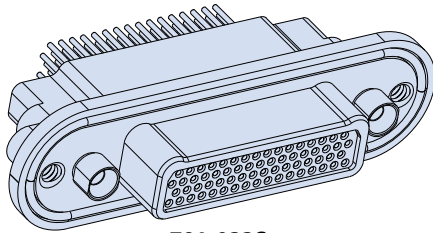

791-033S
Panel Mount PCB Plug

Harsh environment. Rugged construction. Ultraminiature. Series 791 connectors are the next-generation higher density alternative to M24308 D Subminiature and other rack-and-panel connectors. Dual lobe shell, mating receptacle has recessed pins to prevent scooping damage. Epoxy-sealed terminals. Aluminum shell, thermoplastic insulator, gold-plated copper alloy contacts, Integral board standoffs, threaded board mount holes. 5A to 46A current rating depending on contact size.

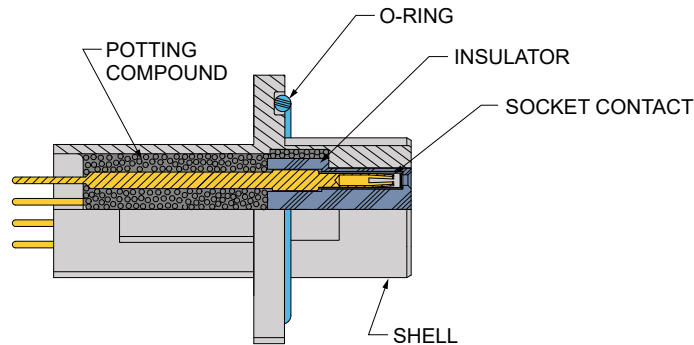

RELIABLE DESIGN

- 100% scoop-proof
- Machined aluminum shell
- Sealed PC tail contacts
- EMI shell-to-shell continuity
- Blind mate capability

VERSATILE

- Wide range of configurations
- Signal, power
- Rear panel mount

HARSH ENVIRONMENT

- Humidity, water ingress
- Shock and vibration
- Temperature extremes
- Corrosion resistance
- High altitude

SIZE AND WEIGHT SAVING

- High density

How To Order

Sample Part Number	791-033S	M-102	MT	N	F	C
Product	791-033S Panel mount plug connector, straight PC tail, socket contacts					
Arrangement Number (Shell Size - Insert Arr.)	See Table 2					
Shell Finish	M = Electroless Nickel MT = Nickel-PTFE ZR = Black Zinc-Nickel					
Hardware Option (Table 1)	N = No hardware P = Jackpost G = Male guide pin B = Female guide bushing					
O-ring Option	N = No O-ring F = Fluorosilicone O-ring (non-conductive) C = Conductive fluorosilicone O-ring S = Metal EMI panel spring (non-environmental)					
PC Tail Length	A = .125 inch (3.18) B = .250 inch (6.35) C = .375 inch (9.53)					

Metal EMI Panel Spring

A gold-plated panel spring option is available for Series 791 connectors with panel mount flanges. This spring provides improved electrical bonding. Specify Code S. Non-environmental.



Specifications

- Operating temperature: -65 to +150°C
 - Current and voltage ratings:
- | Contact Size | Amps, max. | DWV Vac rms |
|--------------|------------|-------------|
| 23 | 5 | 750 |
| 16 | 13 | 1800 |
| 12 | 23 | 1800 |
| 8 | 46 | 1800 |
- Shock: EIA-364-27 condition D
 - Vibration: EIA-364-28 condition V, letter E
 - See pages 8-10 for additional information

Construction

- Shell: aluminum alloy
- Insulators: high grade rigid dielectric
- Contacts: copper alloy, 50 microinches gold over nickel plating
- Encapsulant: epoxy
- O-ring: fluorosilicone
- Hardware: stainless steel, passivated
- O-ring (code F): fluorosilicone
- Conductive O-ring (code C): silver plated, aluminum-filled fluorosilicone
- Metal EMI panel spring (code S): beryllium copper, gold plated

Panel Mount Printed Circuit Board Connectors

791-033S Panel Mount Plug Connectors with Straight PCB Socket Contacts

Table 1 Hardware Option











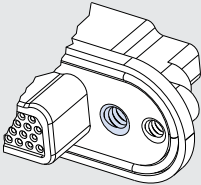
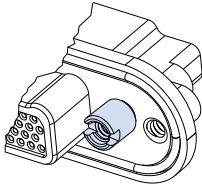
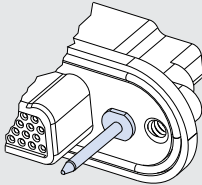
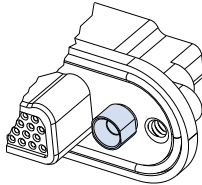









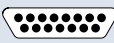





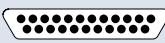
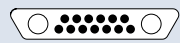



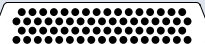

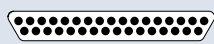
 N No Hardware Connector supplied with threaded holes, .150 (3.8) minimum depth. Shell sizes A-G, J, K have 6-32 UNC-2B thread, sizes H and L have 8-32 UNC-2B thread. Size M has 10-32 UNF-2B thread.	 P Jackposts Non-removable female jackpost. Shell sizes A-G, J, K have 4-40 UNC-2B thread, sizes H and L have 6-32 UNC-2B thread. Size M has 8-32 UNC-2B thread. 300 series stainless steel, passivated.	 G Guide Pins Non-removable, 300 series stainless steel guide pins for blind mating applications. Use with guide bushing on mating connector.	 B Guide Bushing Non-removable, 300 series stainless steel female guide bushings for blind mating applications. Use with guide pin on mating connector.
--	--	--	---

Table 2 Arrangement Number

Arrangements with Size #23 Contacts	Arrangements with Size #16 Contacts	Arrangements with Size #12 Contacts
 A-5 5 #23	 B-2P2 2 #16	 G-13P2 11 #23, 2 #12
 B-9 9 #23	 D-3P3 3 #16	 G-3P3 3 #12
 C-13 13 #23	 D-7P2 5 #23, 2 #16	 G-21P1 20 #23, 1 #12
 D-15 15 #23	 E-11P2 9 #23, 2 #16	 H-10P4 6 #23, 4 #12
 E-19 19 #23	 E-7P3 4 #23, 3 #16	 H-36P2 34 #23, 2 #12
 F-23 23 #23	 F-15P2 13 #23, 2 #16	 H-5P5 5 #12
 G-33 33 #23	 F-5P5 5 #16	 L-6P6 6 #12
 H-66 66 #23	 H-29P7 22 #23, 7 #16	Arrangements with Size #8 Contacts  M-4P4 Supplied with 4 #8 Power Contacts
 J-33 33 #23	 J-17P4 13 #23, 4 #16	
 K-43 43 #23	 J-25P2 23 #23, 2 #16	
 L-78 78 #23	 J-7P7 7 #16	
 M-102 102 #23	 K-27P4 23 #23, 4 #16	
	 K-35P2 33 #23, 2 #16	
	 K-9P9 9 #16	
	 M-17P17 17 #16	

Panel Mount Printed Circuit Board Connectors

791-033S Panel Mount Plug Connectors with Straight PCB Socket Contacts

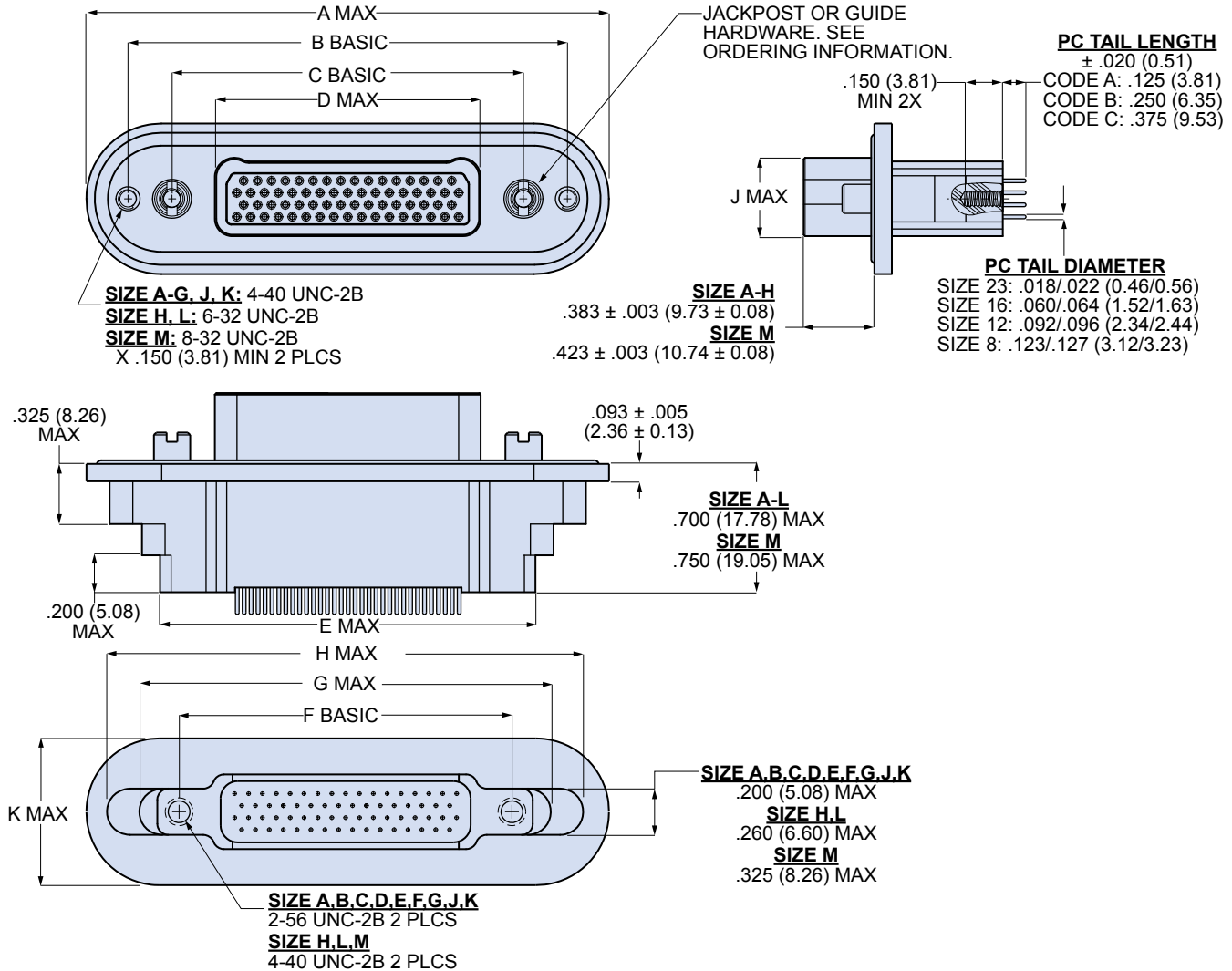

791-033S Dimensions

Shell Size	A Max		B Basic		C Basic		D Max		E Max		F Basic		G Max		H Max		J Max		K Max	
	In.	mm.	In.	mm.	In.	mm.	In.	mm.	In.	mm.	In.	mm.	In.	mm.	In.	mm.	In.	mm.	In.	mm.
A	1.565	39.75	1.150	29.21	.410	10.41	.410	10.41	.760	19.30	.565	14.35	.960	24.38	1.345	34.16	.320	8.13	.710	18.03
B	1.715	43.56	1.300	33.02	.560	14.22	.560	14.22	.910	21.11	.715	18.16	1.110	28.19	1.495	37.97	.320	8.13	.710	18.03
C	1.865	55.34	1.450	36.83	.710	18.03	.710	18.03	1.060	26.92	.865	21.97	1.260	32.00	1.645	41.78	.320	8.13	.710	18.03
D	1.940	49.28	1.525	38.74	.785	19.94	.785	19.94	1.160	29.46	.965	24.51	1.360	34.54	1.745	44.32	.320	8.13	.710	18.03
E	2.090	53.09	1.675	42.55	.935	23.75	.935	23.75	1.310	33.27	1.115	28.32	1.510	38.35	1.895	48.13	.320	8.13	.710	18.03
F	2.240	56.60	1.825	46.36	1.085	27.56	1.085	27.56	1.460	37.08	1.265	32.13	1.660	42.16	2.045	51.94	.320	8.13	.710	18.03
G	2.200	55.88	1.785	45.34	1.047	26.59	1.047	31.07	1.410	35.81	1.215	30.86	1.633	41.48	1.983	50.37	.420	10.67	.800	20.32
H	2.835	72.01	2.375	60.34	1.437	36.50	1.437	36.50	2.045	51.94	1.800	45.72	2.240	56.90	2.590	65.79	.430	10.92	.820	20.83
J	2.615	66.42	2.200	55.88	1.460	37.08	1.460	37.08	1.810	45.97	1.615	41.02	2.010	51.05	2.395	60.83	.320	8.13	.710	18.03
K	2.990	75.95	2.575	65.41	1.835	46.61	1.835	46.61	2.210	56.13	2.015	51.18	2.410	61.21	2.795	70.99	.320	8.13	.710	18.03
L	3.075	78.11	2.611	66.32	1.673	42.49	1.673	42.50	2.281	57.93	2.036	51.71	2.476	62.89	2.826	71.78	.430	10.92	.820	20.83
M	3.345	84.96	2.824	71.73	1.734	44.04	1.734	44.04	2.445	62.10	2.200	55.88	2.650	67.31	3.090	78.49	.515	13.08	.925	23.50

Panel Mount Printed Circuit Board Connectors

791-033S Panel Mount Plug Connectors with Straight PCB Socket Contacts

Recommended Panel Cutout

SHELL SIZES A-G, J, K

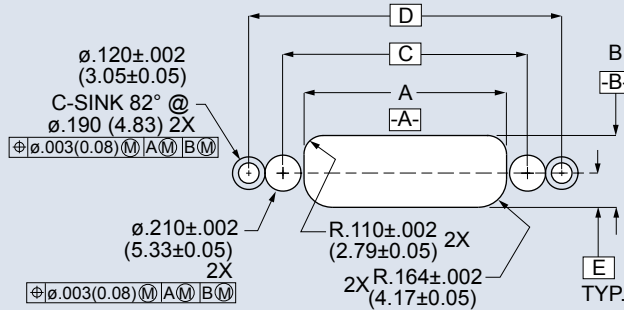

SHELL SIZES H, L

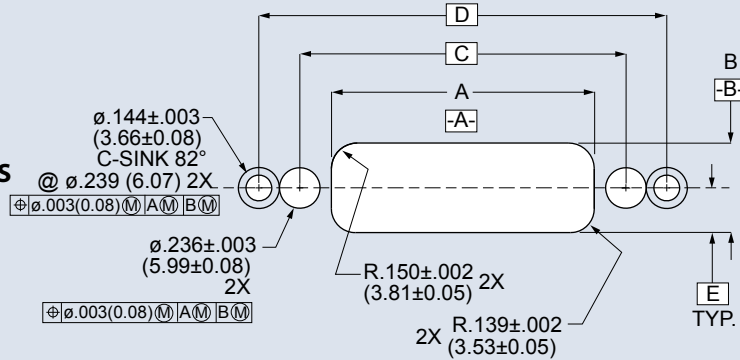

SHELL SIZE M

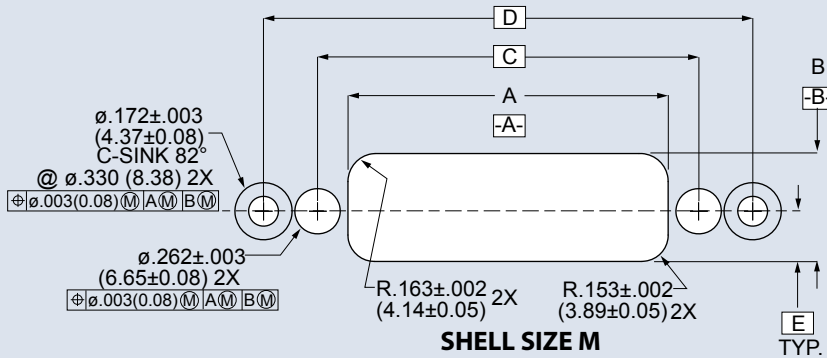

Application Notes

1. Supplied with (2) flat head screws for panel mounting. 82° c-sink with reduced head diameter to fit recommended panel cutout. Slot drive, stainless steel.

2. Blind Mate Tolerances

Shell Size	Maximum allowable misalignment from centerline
A - G, J, K	.030 (0.76)
H, L	.040 (1.02)
M	.050 (1.27)

Shell Size	A ±.002(0.05)		B ±.002(0.05)		C Basic		D Basic		E Basic	
	In.	mm.	In.	mm.	In.	mm.	In.	mm.	In.	mm.
A	.505	12.83	.418	10.62	.750	19.50	1.150	29.21	.199	5.05
B	.655	16.64	.418	10.62	.900	22.86	1.300	33.02	.199	5.05
C	.805	20.45	.418	10.62	1.050	26.67	1.450	36.83	.199	5.05
D	.880	22.35	.418	10.62	1.125	28.58	1.525	38.74	.199	5.05
E	1.030	26.16	.418	10.62	1.275	32.39	1.675	42.55	.199	5.05
F	1.180	29.97	.418	10.62	1.425	36.20	1.825	46.36	.199	5.05
G	1.142	29.01	.506	12.85	1.388	35.25	1.786	45.34	.244	6.20
H	1.531	38.89	.521	13.23	1.900	48.26	2.375	60.34	.250	6.35
J	1.555	39.50	.418	10.62	1.800	45.72	2.200	55.88	.199	5.05
K	1.930	49.02	.418	10.62	2.175	55.25	2.575	65.41	.199	5.05
L	1.767	44.88	.521	13.23	2.136	54.26	2.611	66.32	.250	6.35
M	1.850	46.99	.623	15.82	2.200	55.88	2.824	71.73	.290	7.37

Panel Mount Printed Circuit Board Connectors

791-021P Panel Mount Receptacle Connectors with Straight PCB Pin Contacts

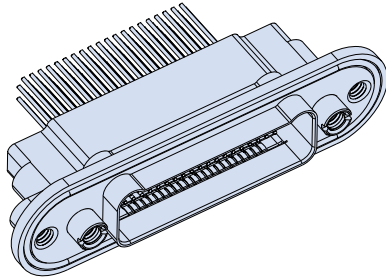

791-021P
Panel Mount PCB Receptacle

Harsh environment. Rugged construction. Ultraminiature. Series 791 connectors are the next-generation higher density alternative to M24308 D Subminiature and other rack-and-panel connectors. Dual lobe shell with recessed pin contacts to prevent scooping damage. Epoxy-sealed terminals. Aluminum shell, thermoplastic insulator, gold-plated copper alloy contacts, Integral board standoffs, threaded board mount holes.

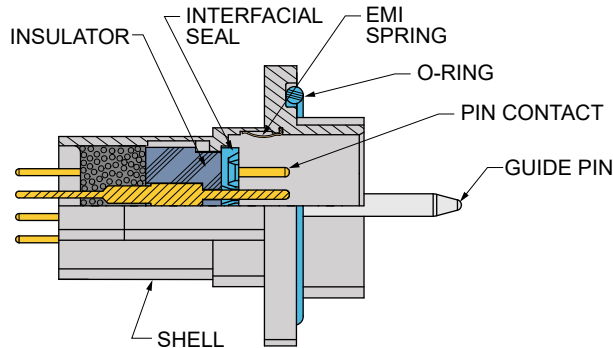

RELIABLE DESIGN

- 100% scoop-proof
- Machined aluminum shell
- Sealed PC tail contacts
- EMI shell-to-shell continuity
- Blind mate capability

VERSATILE

- Wide range of configurations
- Signal, power
- Rear panel mount

HARSH ENVIRONMENT

- Humidity, water ingress
- Shock and vibration
- Temperature extremes
- Corrosion resistance
- High altitude

SIZE AND WEIGHT SAVING

- High density

How To Order

Sample Part Number	791-021P	J-25P2	M	E	P	F	A
Product	791-021P Panel mount receptacle, straight PC tail, pin contacts						
Arrangement Number (Shell Size - Insert Arr.)	<i>See Table 2</i>						
Shell Finish	M = Electroless Nickel MT = Nickel-PTFE ZR = Black Zinc-Nickel						
EMI Spring	E = EMI spring N = No EMI spring						
Hardware Option (Table 1)	N = No hardware P = Jackpost G = Male guide pin B = Female guide bushing						
O-ring Option	N = No O-ring F = Fluorosilicone O-ring (non-conductive) C = Conductive fluorosilicone O-ring S = Metal EMI panel spring (non-environmental)						
PC Tail Length	A = .125 inch (3.18) B = .250 inch (6.35) C = .375 inch (9.53)						

Metal EMI Panel Spring

A gold-plated panel spring option is available for Series 791 connectors with panel mount flanges. This spring provides improved electrical bonding. Specify Code S. Non-environmental.



Specifications

- **Operating temperature:** -65 to +150°C
- **Current and voltage ratings:**

Contact Size	Amps, max.	DWV Vac rms
23	5	750
16	13	1800
12	23	1800
8	46	1800
- **Shock:** EIA-364-27 condition D
- **Vibration:** EIA-364-28 condition V, letter E
- See pages 8-10 for additional information

Construction

- **Shell:** aluminum alloy
- **Insulators:** high grade rigid dielectric
- **Contacts:** copper alloy, 50 microinches gold over nickel plating
- **Encapsulant:** epoxy
- **Interfacial seal:** fluorosilicone
- **EMI spring:** beryllium copper, nickel plated
- **Hardware:** stainless steel, passivated
- **O-ring (code F):** fluorosilicone
- **Conductive O-ring (code C):** silver plated, aluminum-filled fluorosilicone
- **Metal EMI panel spring (code S):** beryllium copper, gold plated

Panel Mount Printed Circuit Board Connectors

791-021P Panel Mount Receptacle Connectors with Straight PCB Pin Contacts

Table 1 Hardware Option











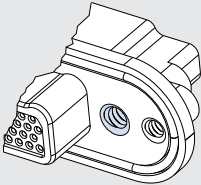
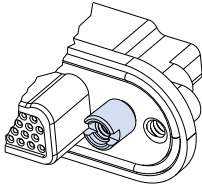
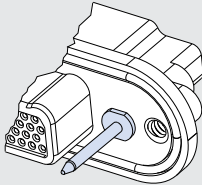
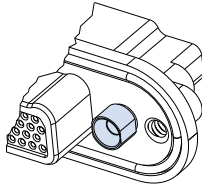















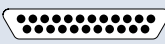
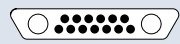

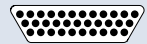

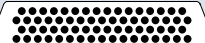

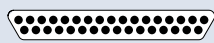

 N No Hardware Connector supplied with threaded holes, .150 (3.8) minimum depth. Shell sizes A-G, J, K have 6-32 UNC-2B thread, sizes H and L have 8-32 UNC-2B thread. Size M has 10-32 UNF-2B thread.	 P Jackposts Non-removable female jackpost. Shell sizes A-G, J, K have 4-40 UNC-2B thread, sizes H and L have 6-32 UNC-2B thread. Size M has 8-32 UNC-2B thread. 300 series stainless steel, passivated.	 G Guide Pins Non-removable, 300 series stainless steel guide pins for blind mating applications. Use with guide bushing on mating connector.	 B Guide Bushing Non-removable, 300 series stainless steel female guide bushings for blind mating applications. Use with guide pin on mating connector.
--	--	--	---

Table 2 Arrangement Number

Arrangements with Size #23 Contacts	Arrangements with Size #16 Contacts	Arrangements with Size #12 Contacts
 A-5 5 #23	 B-2P2 2 #16	 G-13P2 11 #23, 2 #12
 B-9 9 #23	 D-3P3 3 #16	 G-3P3 3 #12
 C-13 13 #23	 D-7P2 5 #23, 2 #16	 G-21P1 20 #23, 1 #12
 D-15 15 #23	 E-11P2 9 #23, 2 #16	 H-10P4 6 #23, 4 #12
 E-19 19 #23	 E-7P3 4 #23, 3 #16	 H-36P2 34 #23, 2 #12
 F-23 23 #23	 F-15P2 13 #23, 2 #16	 H-5P5 5 #12
 G-33 33 #23	 F-5P5 5 #16	 L-6P6 6 #12
 H-66 66 #23	 H-29P7 22 #23, 7 #16	Arrangements with Size #8 Contacts  M-4P4 Supplied with 4 #8 Power Contacts
 J-33 33 #23	 H-54P2 52 #23, 2 #16	
 K-43 43 #23	 J-17P4 13 #23, 4 #16	
 L-78 78 #23	 J-25P2 23 #23, 2 #16	
 M-102 102 #23	 J-7P7 7 #16	
	 K-27P4 23 #23, 4 #16	
	 K-35P2 33 #23, 2 #16	
	 K-9P9 9 #16	
	 M-17P17 17 #16	

Panel Mount Printed Circuit Board Connectors

791-021P Panel Mount Receptacle Connectors with Straight PCB Pin Contacts

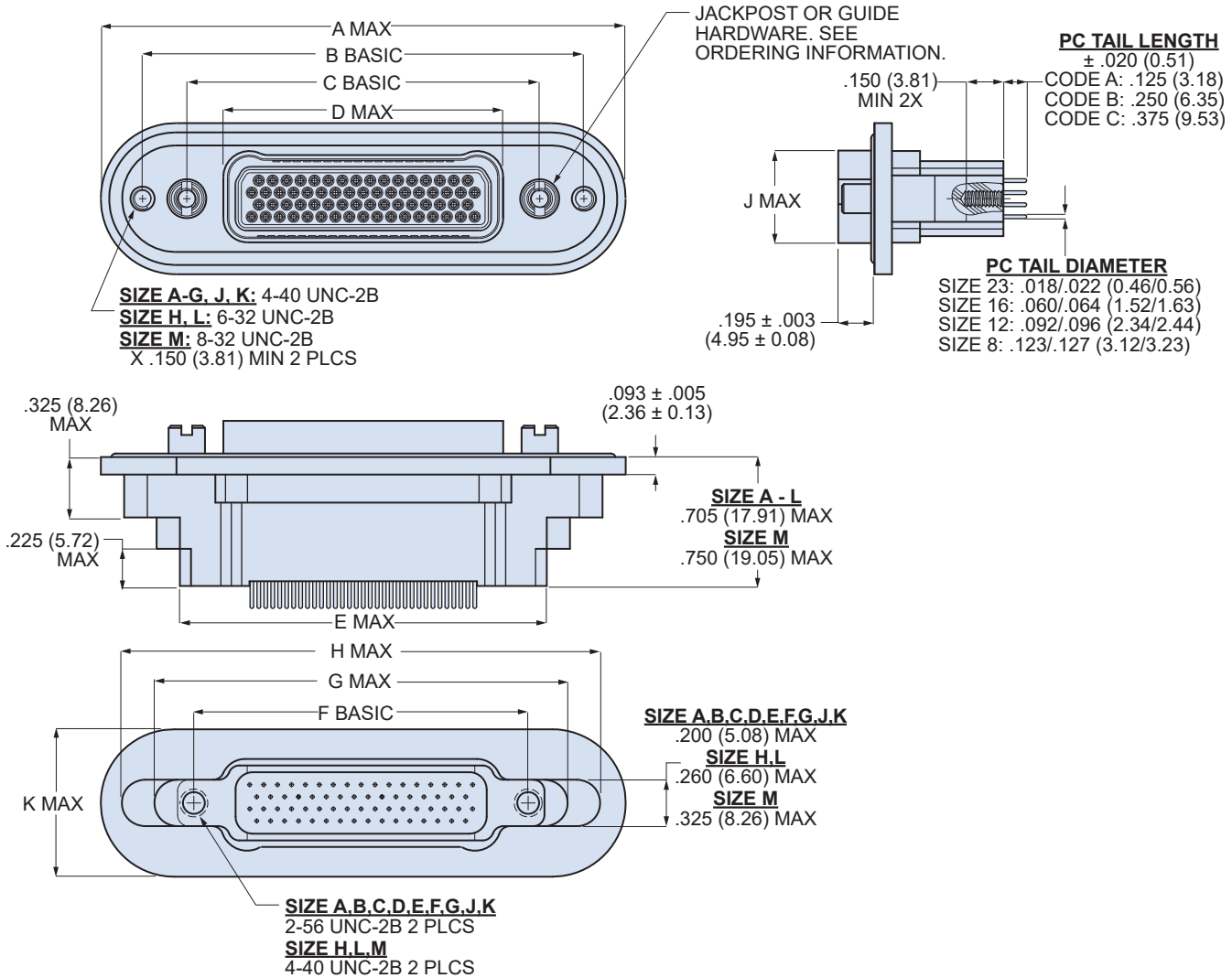

791-021P Dimensions

Shell Size	A Max		B Basic		C Basic		D Max		E Max		F Basic		G Max		H Max		J Max		K Max	
	In.	mm.	In.	mm.	In.	mm.	In.	mm.	In.	mm.	In.	mm.	In.	mm.	In.	mm.	In.	mm.	In.	mm.
A	1.565	39.75	1.150	29.21	.750	19.05	.490	12.45	.760	19.30	.565	14.35	.960	24.38	1.345	34.16	.400	10.16	.710	18.03
B	1.715	43.56	1.300	33.02	.900	22.86	.630	16.00	.910	21.11	.715	18.16	1.110	28.19	1.495	37.97	.400	10.16	.710	18.03
C	1.865	55.34	1.450	36.83	1.050	26.67	.780	19.81	1.060	26.92	.865	21.97	1.260	32.00	1.645	41.78	.400	10.16	.710	18.03
D	1.940	49.28	1.525	38.74	1.125	28.58	.855	21.72	1.160	29.46	.965	24.51	1.360	34.54	1.745	44.32	.400	10.16	.710	18.03
E	2.090	53.09	1.675	42.55	1.275	32.38	1.005	25.53	1.310	33.27	1.115	28.32	1.510	38.35	1.895	48.13	.400	10.16	.710	18.03
F	2.240	56.60	1.825	46.36	1.425	36.20	1.155	29.34	1.460	37.08	1.265	32.13	1.660	42.16	2.045	51.94	.400	10.16	.710	18.03
G	2.200	55.88	1.785	45.34	1.388	35.26	1.117	28.37	1.410	35.81	1.215	30.86	1.633	41.48	1.983	50.37	.490	12.45	.800	20.32
H	2.835	72.01	2.375	60.34	1.900	48.26	1.507	38.28	2.045	51.94	1.800	45.72	2.240	56.90	2.590	65.79	.510	12.95	.820	20.83
J	2.615	66.42	2.200	55.88	1.800	45.72	1.530	38.86	1.810	45.97	1.615	41.02	2.010	51.05	2.395	60.83	.400	10.16	.710	18.03
K	2.990	75.95	2.575	65.41	2.175	55.25	1.905	48.39	2.210	56.13	2.015	51.18	2.410	61.21	2.795	70.99	.400	10.16	.710	18.03
L	3.075	78.11	2.611	66.32	2.136	54.25	1.743	44.27	2.281	57.93	2.036	51.71	2.476	62.89	2.826	71.78	.510	12.95	.820	20.83
M	3.345	84.96	2.824	71.73	2.200	55.88	1.804	45.82	2.445	62.10	2.200	55.88	2.650	67.31	3.090	78.49	.575	14.61	.925	23.50

Panel Mount Printed Circuit Board Connectors

791-021P Panel Mount Receptacle Connectors with Straight PCB Pin Contacts

Recommended Panel Cutout

SHELL SIZES A-G, J, K

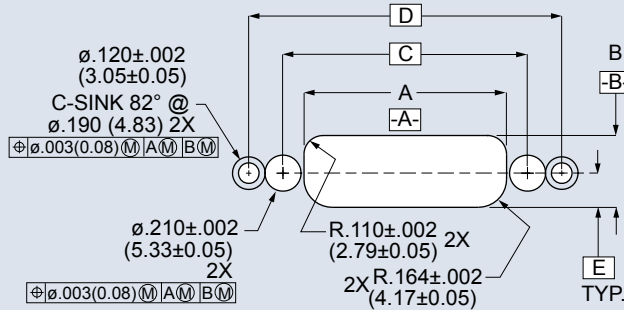

SHELL SIZES H, L

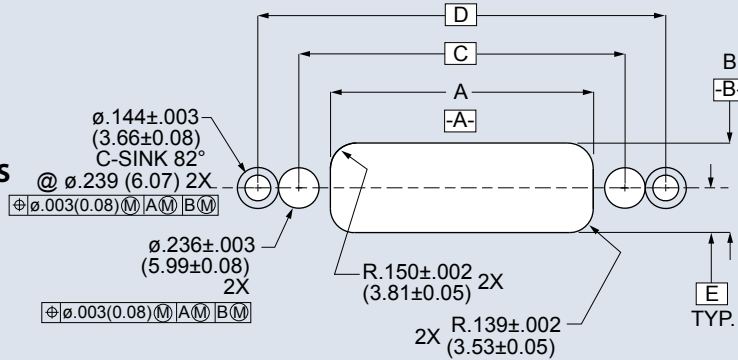

SHELL SIZE M

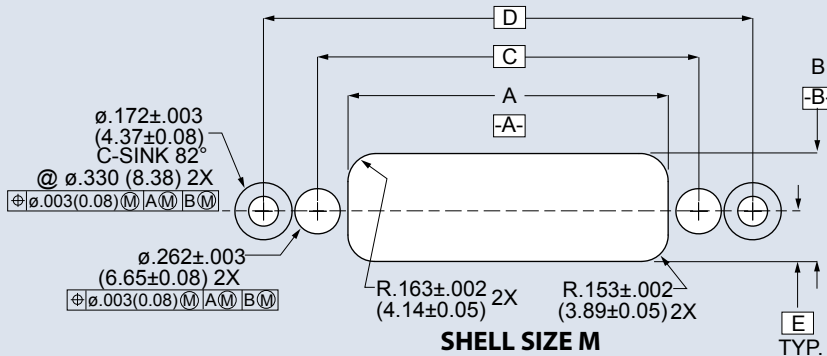

Application Notes

- Supplied with (2) flat head screws for panel mounting. 82° c-sink with reduced head diameter to fit recommended panel cutout. Slot drive, stainless steel.

2. Blind Mate Tolerances

Shell Size	Maximum allowable misalignment from centerline
A - G, J, K	.030 (0.76)
H, L	.040 (1.02)
M	.050 (1.27)

Shell Size	A ±.002(0.05)		B ±.002(0.05)		C Basic		D Basic		E Basic	
	In.	mm.	In.	mm.	In.	mm.	In.	mm.	In.	mm.
A	.505	12.83	.418	10.62	.750	19.50	1.150	29.21	.199	5.05
B	.655	16.64	.418	10.62	.900	22.86	1.300	33.02	.199	5.05
C	.805	20.45	.418	10.62	1.050	26.67	1.450	36.83	.199	5.05
D	.880	22.35	.418	10.62	1.125	28.58	1.525	38.74	.199	5.05
E	1.030	26.16	.418	10.62	1.275	32.39	1.675	42.55	.199	5.05
F	1.180	29.97	.418	10.62	1.425	36.20	1.825	46.36	.199	5.05
G	1.142	29.01	.506	12.85	1.388	35.25	1.786	45.34	.244	6.20
H	1.531	38.89	.521	13.23	1.900	48.26	2.375	60.34	.250	6.35
J	1.555	39.50	.418	10.62	1.800	45.72	2.200	55.88	.199	5.05
K	1.930	49.02	.418	10.62	2.175	55.25	2.575	65.41	.199	5.05
L	1.767	44.88	.521	13.23	2.136	54.26	2.611	66.32	.250	6.35
M	1.850	46.99	.623	15.82	2.200	55.88	2.824	71.73	.290	7.37

Panel Mount Printed Circuit Board Connectors

791-012S Panel Mount Plug Connectors with Right Angle PCB Socket Contacts

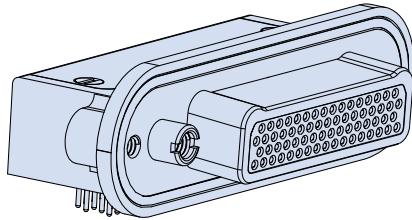

791-012S
Panel Mount PCB Plug

Harsh environment. Rugged construction. Ultraminiature. Series 791 connectors are the next-generation higher density alternative to M24308 D Subminiature and other rack-and-panel connectors. Dual lobe shell, mating receptacle has recessed pins to prevent scooping damage. Epoxy-sealed terminals. Aluminum shell, thermoplastic insulator, gold-plated copper alloy contacts, Integral board standoffs, threaded board mount holes. 5A to 46A current rating depending on contact size.

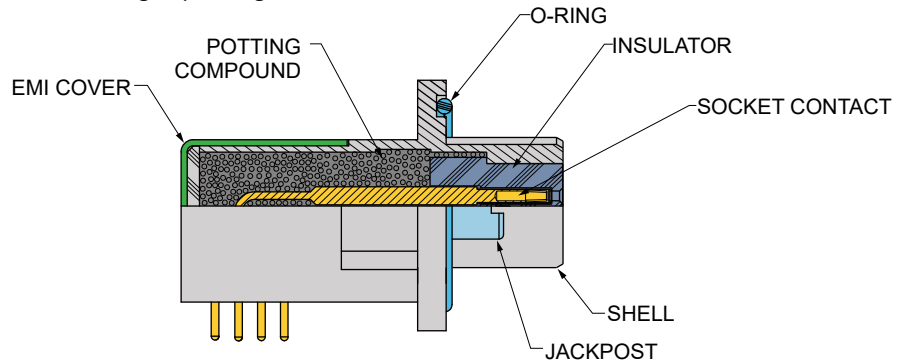

RELIABLE DESIGN

- 100% scoop-proof
- Machined aluminum shell
- Sealed PC tail contacts
- EMI shell-to-shell continuity
- Blind mate capability

VERSATILE

- Wide range of configurations
- Signal, power
- Rear panel mount

HARSH ENVIRONMENT

- Humidity, water ingress
- Shock and vibration
- Temperature extremes
- Corrosion resistance
- High altitude

SIZE AND WEIGHT SAVING

- High density

How To Order

Sample Part Number	791-012S	J-17P4	ZR	G	C	A
Product	791-012S Panel mount plug, right angle PC tail, socket contacts					
Arrangement Number (Shell Size - Insert Arr.)	See Table 2					
Shell Finish	M = Electroless Nickel MT = Nickel-PTFE ZR = Black Zinc-Nickel					
Hardware Option (Table 1)	N = No hardware) P = Jackpost G = Male guide pin B = Female guide bushing					
O-ring Option	N = No O-ring F = Fluorosilicone O-ring (non-conductive) C = Conductive fluorosilicone O-ring S = Metal EMI panel spring (non-environmental)					
PC Tail Length	A = .125 inch (3.18) B = .250 inch (6.35) C = .375 inch (9.53)					

Metal EMI Panel Spring

A gold-plated panel spring option is available for Series 791 connectors with panel mount flanges. This spring provides improved electrical bonding. Specify Code S. Non-environmental.



Specifications

- **Operating temperature:** -65 to +150°C
- **Current and voltage ratings:**

Contact Size	Amps, max.	DWV Vac rms
23	5	750
16	13	1800
12	23	1800
8	46	1800
- **Shock:** EIA-364-27 condition D
- **Vibration:** EIA-364-28 condition V, letter E
- See pages 8-10 for additional information

Construction

- **Shell:** aluminum alloy
- **Insulators:** high grade rigid dielectric
- **Contacts:** copper alloy, 50 microinches gold over nickel plating
- **Encapsulant:** epoxy
- **O-ring:** fluorosilicone
- **EMI cover:** aluminum, same finish as shell
- **Hardware:** stainless steel, passivated
- **O-ring (code F):** fluorosilicone
- **Conductive O-ring (code C):** silver plated, aluminum-filled fluorosilicone
- **Metal EMI panel spring (code S):** beryllium copper, gold plated

Panel Mount Printed Circuit Board Connectors

791-012S Panel Mount Plug Connectors with Right Angle PCB Socket Contacts

Table 1 Hardware Option











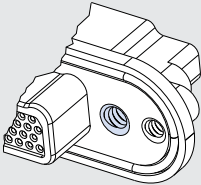
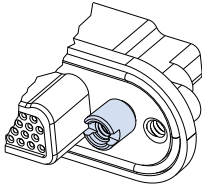
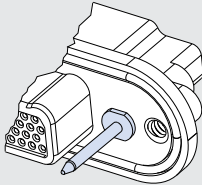
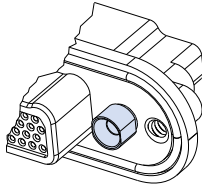

























 N No Hardware Connector supplied with threaded holes, .150 (3.8) minimum depth. Shell sizes A-G, J, K have 6-32 UNC-2B thread, sizes H and L have 8-32 UNC-2B thread. Size M has 10-32 UNF-2B thread.	 P Jackposts Non-removable female jackpost. Shell sizes A-G, J, K have 4-40 UNC-2B thread, sizes H and L have 6-32 UNC-2B thread. Size M has 8-32 UNC-2B thread. 300 series stainless steel, passivated.	 G Guide Pins Non-removable, 300 series stainless steel guide pins for blind mating applications. Use with guide bushing on mating connector.	 B Guide Bushing Non-removable, 300 series stainless steel female guide bushings for blind mating applications. Use with guide pin on mating connector.
--	--	--	---

Table 2 Arrangement Number

Arrangements with Size #23 Contacts	Arrangements with Size #16 Contacts	Arrangements with Size #12 Contacts
 A-5 5 #23	 B-2P2 2 #16	 G-13P2 11 #23, 2 #12
 B-9 9 #23	 D-3P3 3 #16	 G-3P3 3 #12
 C-13 13 #23	 D-7P2 5 #23, 2 #16	 G-21P1 20 #23, 1 #12
 D-15 15 #23	 E-11P2 9 #23, 2 #16	 H-10P4 6 #23, 4 #12
 E-19 19 #23	 E-7P3 4 #23, 3 #16	 H-36P2 34 #23, 2 #12
 F-23 23 #23	 F-15P2 13 #23, 2 #16	 H-5P5 5 #12
 G-33 33 #23	 F-5P5 5 #16	 L-6P6 6 #12
 H-66 66 #23	 H-29P7 22 #23, 7 #16	Arrangements with Size #8 Contacts  M-4P4 Supplied with 4 #8 Power Contacts
 J-33 33 #23	 J-17P4 13 #23, 4 #16	
 K-43 43 #23	 J-25P2 23 #23, 2 #16	
 L-78 78 #23	 J-7P7 7 #16	
 M-102 102 #23	 K-27P4 23 #23, 4 #16	
	 K-35P2 33 #23, 2 #16	
	 K-9P9 9 #16	
	 M-17P17 17 #16	

Panel Mount Printed Circuit Board Connectors

791-012S Panel Mount Plug Connectors with Right Angle PCB Socket Contacts

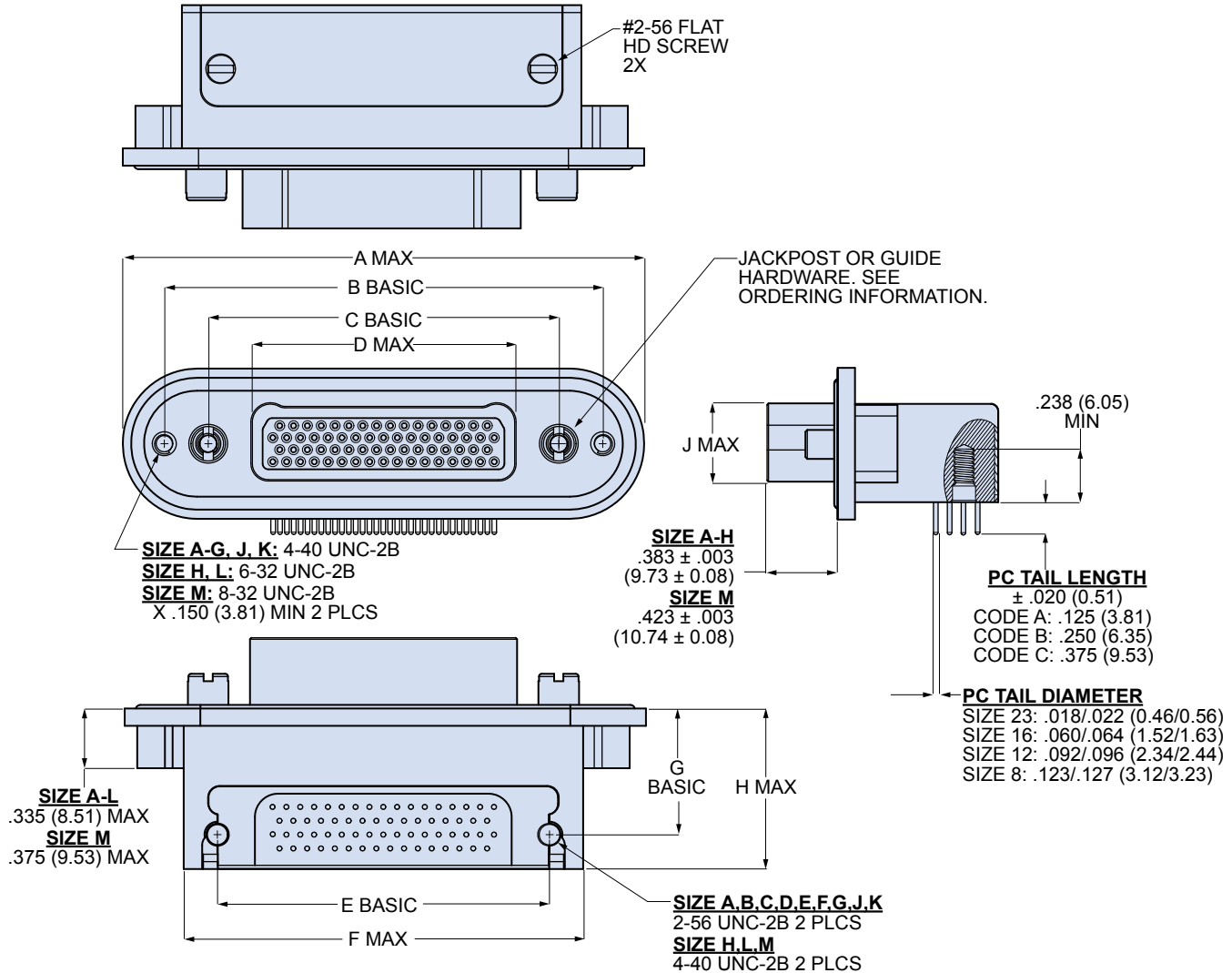

791-012S Dimensions

Shell Size	A Max		B Basic		C Basic		D Max		E Basic		F Max		G Basic		H Max		J Max	
	In.	mm.	In.	mm.	In.	mm.	In.	mm.	In.	mm.	In.	mm.	In.	mm.	In.	mm.	In.	mm.
A	1.565	39.75	1.150	29.21	.750	19.05	.410	10.41	.565	14.35	.990	25.15	.610	15.49	.725	18.42	.320	8.13
B	1.715	43.56	1.300	33.02	.900	22.86	.560	14.22	.715	18.16	1.140	28.96	.610	15.49	.725	18.42	.320	8.13
C	1.865	55.34	1.450	36.83	1.050	26.67	.710	18.03	.865	21.97	1.290	32.77	.610	15.49	.725	18.42	.320	8.13
D	1.940	49.28	1.525	38.74	1.125	28.58	.785	19.94	.965	24.51	1.365	34.67	.610	15.49	.725	18.42	.320	8.13
E	2.090	53.09	1.675	42.55	1.275	32.38	.935	23.75	1.115	28.32	1.515	38.48	.610	15.49	.725	18.42	.320	8.13
F	2.240	56.60	1.825	46.36	1.425	36.20	1.085	27.56	1.265	32.13	1.665	42.29	.610	15.49	.725	18.42	.320	8.13
G	2.200	55.88	1.785	45.34	1.388	35.26	1.047	26.59	1.215	30.86	1.625	41.28	.682	17.37	.800	20.32	.420	10.67
H	2.835	72.01	2.375	60.34	1.900	48.26	1.437	36.50	1.800	45.72	2.175	55.25	.691	17.55	.880	22.35	.430	10.92
J	2.615	66.42	2.200	55.88	1.800	45.72	1.460	37.08	1.615	41.02	2.040	51.82	.610	15.49	.725	18.42	.320	8.13
K	2.990	75.95	2.575	65.41	2.175	55.25	1.835	46.61	2.015	51.18	2.415	61.34	.610	15.49	.725	18.42	.320	8.13
L	3.075	78.11	2.611	66.32	2.136	54.26	1.673	42.49	2.036	51.71	2.411	61.24	.691	17.55	.880	22.35	.430	10.92
M	3.345	84.96	2.824	71.73	2.200	55.88	1.734	44.04	2.200	55.88	2.580	66.53	.798	20.27	.995	25.27	.515	13.08

Panel Mount Printed Circuit Board Connectors

791-012S Panel Mount Plug Connectors with Right Angle PCB Socket Contacts

Recommended Panel Cutout

SHELL SIZES A-G, J, K

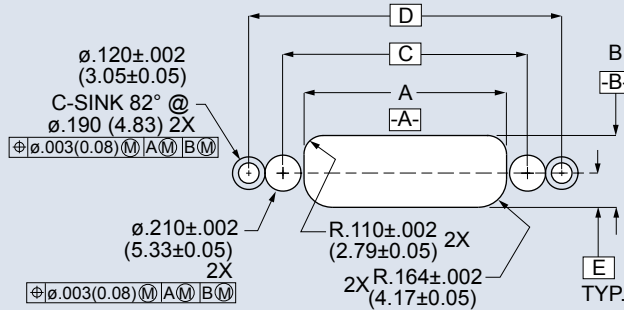

SHELL SIZES H, L

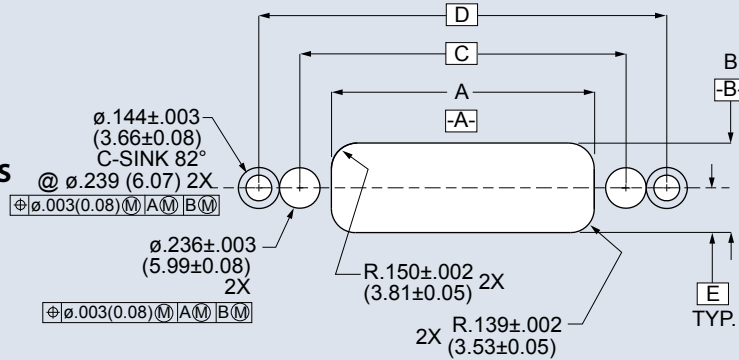

SHELL SIZE M

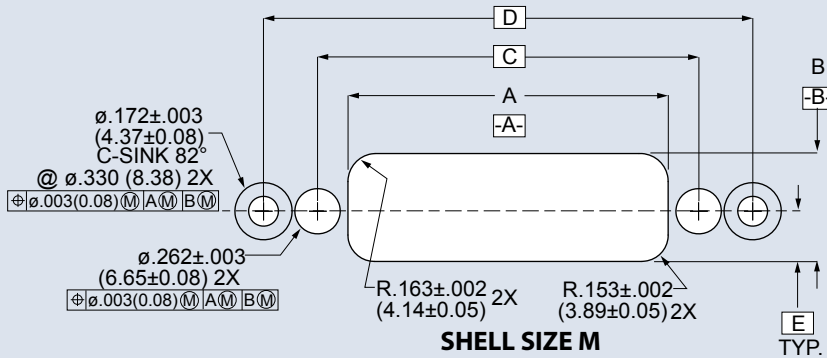

Application Notes

- Supplied with (2) flat head screws for panel mounting. 82° c-sink with reduced head diameter to fit recommended panel cutout. Slot drive, stainless steel.

2. Blind Mate Tolerances

Shell Size	Maximum allowable misalignment from centerline
A - G, J, K	.030 (0.76)
H, L	.040 (1.02)
M	.050 (1.27)

Shell Size	A ±.002(0.05)		B ±.002(0.05)		C Basic		D Basic		E Basic	
	In.	mm.	In.	mm.	In.	mm.	In.	mm.	In.	mm.
A	.505	12.83	.418	10.62	.750	19.50	1.150	29.21	.199	5.05
B	.655	16.64	.418	10.62	.900	22.86	1.300	33.02	.199	5.05
C	.805	20.45	.418	10.62	1.050	26.67	1.450	36.83	.199	5.05
D	.880	22.35	.418	10.62	1.125	28.58	1.525	38.74	.199	5.05
E	1.030	26.16	.418	10.62	1.275	32.39	1.675	42.55	.199	5.05
F	1.180	29.97	.418	10.62	1.425	36.20	1.825	46.36	.199	5.05
G	1.142	29.01	.506	12.85	1.388	35.25	1.786	45.34	.244	6.20
H	1.531	38.89	.521	13.23	1.900	48.26	2.375	60.34	.250	6.35
J	1.555	39.50	.418	10.62	1.800	45.72	2.200	55.88	.199	5.05
K	1.930	49.02	.418	10.62	2.175	55.25	2.575	65.41	.199	5.05
L	1.767	44.88	.521	13.23	2.136	54.26	2.611	66.32	.250	6.35
M	1.850	46.99	.623	15.82	2.200	55.88	2.824	71.73	.290	7.37

Panel Mount Printed Circuit Board Connectors

791-011P Panel Mount Receptacle Connectors with Right Angle PCB Pin Contacts

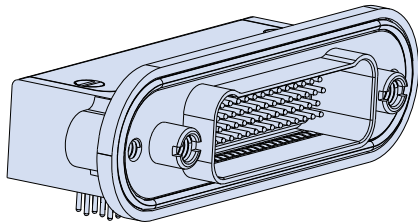

791-011P
Panel Mount PCB Receptacle

Harsh environment. Rugged construction. Ultraminiature. Series 791 connectors are the next-generation higher density alternative to M24308 D Subminiature and other rack-and panel connectors. Dual lobe shell, recessed pins to prevent scooping damage. Epoxy-sealed terminals. Aluminum shell, thermoplastic insulator, gold-plated copper alloy contacts, Integral board standoffs, threaded board mount holes.

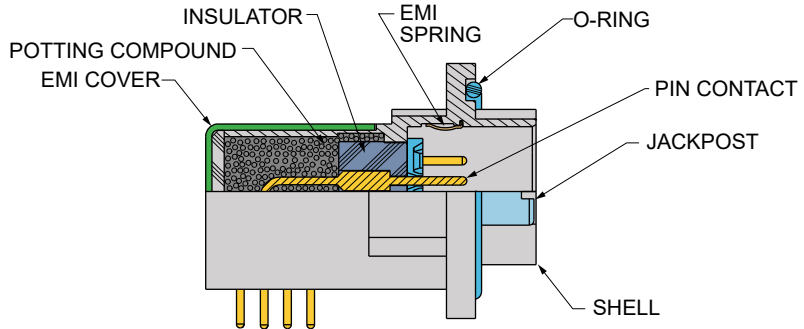

RELIABLE DESIGN

- 100% scoop-proof
- Machined aluminum shell
- Sealed PC tail contacts
- EMI shell-to-shell continuity
- Blind mate capability

VERSATILE

- Wide range of configurations
- Signal, power
- Rear panel mount

HARSH ENVIRONMENT

- Humidity, water ingress
- Shock and vibration
- Temperature extremes
- Corrosion resistance
- High altitude

SIZE AND WEIGHT SAVING

- High density

How To Order

Sample Part Number	791-011P	D-7P2	MT	E	B	S	C
Product	791-011P Panel mount receptacle, 90° PC tail pin contacts						
Arrangement Number (Shell Size - Insert Arr.)	See Table 2						
Shell Finish	M = Electroless Nickel MT = Nickel-PTFE ZR = Black Zinc-Nickel						
EMI Spring	E = EMI spring N = No EMI spring						
Hardware Option (Table 1)	N = No hardware) P = Jackpost G = Male guide pin B = Female guide bushing						
O-ring Option	N = No O-ring F = Fluorosilicone O-ring (non-conductive) C = Conductive fluorosilicone O-ring S = Metal EMI panel spring (non-environmental)						
PC Tail Length	A = .125 inch (3.18) B = .250 inch (6.35) C = .375 inch (9.53)						

Metal EMI Panel Spring

A gold-plated panel spring option is available for Series 791 connectors with panel mount flanges. This spring provides improved electrical bonding. Specify Code S. Non-environmental.



Specifications

- **Operating temperature:** -65 to +150°C
- **Current and voltage ratings:**

Contact Size	Amps, max.	DWV Vac rms
23	5	750
16	13	1800
12	23	1800
8	46	1800
- **Shock:** EIA-364-27 condition D
- **Vibration:** EIA-364-28 condition V, letter E
- See pages 8-10 for additional information

Construction

- **Shell:** aluminum alloy
- **Insulators:** high grade rigid dielectric
- **Contacts:** copper alloy, 50 microinches gold over nickel plating
- **EMI spring:** beryllium copper, nickel plated
- **Encapsulant:** epoxy
- **Interfacial seal:** fluorosilicone
- **EMI cover:** aluminum, same finish as shell
- **Hardware:** stainless steel, passivated
- **O-ring (code F):** fluorosilicone
- **Conductive O-ring (code C):** silver plated, aluminum-filled fluorosilicone
- **Metal EMI panel spring (code S):** beryllium copper, gold plated

Panel Mount Printed Circuit Board Connectors

791-011P Panel Mount Receptacle Connectors with Right Angle PCB Pin Contacts

Table 1 Hardware Option











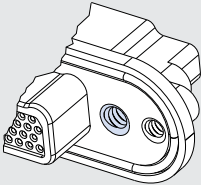
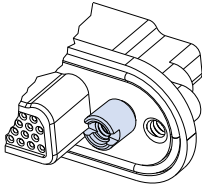
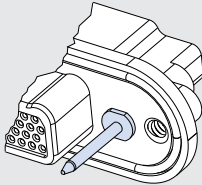
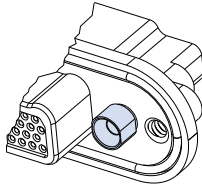



























 <p>N No Hardware</p> <p>Connector supplied with threaded holes, .150 (3.8) minimum depth. Shell sizes A-G, J, K have 6-32 UNC-2B thread, sizes H and L have 8-32 UNC-2B thread. Size M has 10-32 UNF-2B thread.</p>	 <p>P Jackposts</p> <p>Non-removable female jackpost. Shell sizes A-G, J, K have 4-40 UNC-2B thread, sizes H and L have 6-32 UNC-2B thread. Size M has 8-32 UNC-2B thread. 300 series stainless steel, passivated.</p>	 <p>G Guide Pins</p> <p>Non-removable, 300 series stainless steel guide pins for blind mating applications. Use with guide bushing on mating connector.</p>	 <p>B Guide Bushing</p> <p>Non-removable, 300 series stainless steel female guide bushings for blind mating applications. Use with guide pin on mating connector.</p>
---	---	---	--

Table 2 Arrangement Number

Arrangements with Size #23 Contacts	Arrangements with Size #16 Contacts	Arrangements with Size #12 Contacts
 A-5 5 #23  B-9 9 #23  C-13 13 #23	 B-2P2 2 #16  D-3P3 3 #16  D-7P2 5 #23, 2 #16	 G-13P2 11 #23, 2 #12  G-3P3 3 #12  G-21P1 20 #23, 1 #12
 D-15 15 #23  E-19 19 #23	 E-11P2 9 #23, 2 #16  E-7P3 4 #23, 3 #16  F-14P3 11 #23, 3 #16	 H-10P4 6 #23, 4 #12  H-36P2 34 #23, 2 #12
 F-23 23 #23  G-33 33 #23	 F-15P2 13 #23, 2 #16  F-5P5 5 #16	 H-5P5 5 #12
 H-66 66 #23  J-33 33 #23	 H-29P7 22 #23, 7 #16  H-54P2 52 #23, 2 #16	 L-6P6 6 #12
 K-43 43 #23	 J-17P4 13 #23, 4 #16  J-25P2 23 #23, 2 #16	<p style="text-align: center;">Arrangements with Size #8 Contacts</p>  <p style="text-align: center;">M-4P4 Supplied with 4 #8 Power Contacts</p>
 L-78 78 #23	 J-7P7 7 #16  K-27P4 23 #23, 4 #16	
 M-102 102 #23	 K-35P2 33 #23, 2 #16  K-9P9 9 #16  M-17P17 17 #16	

Panel Mount Printed Circuit Board Connectors

791-011P Panel Mount Receptacle Connectors with Right Angle PCB Pin Contacts

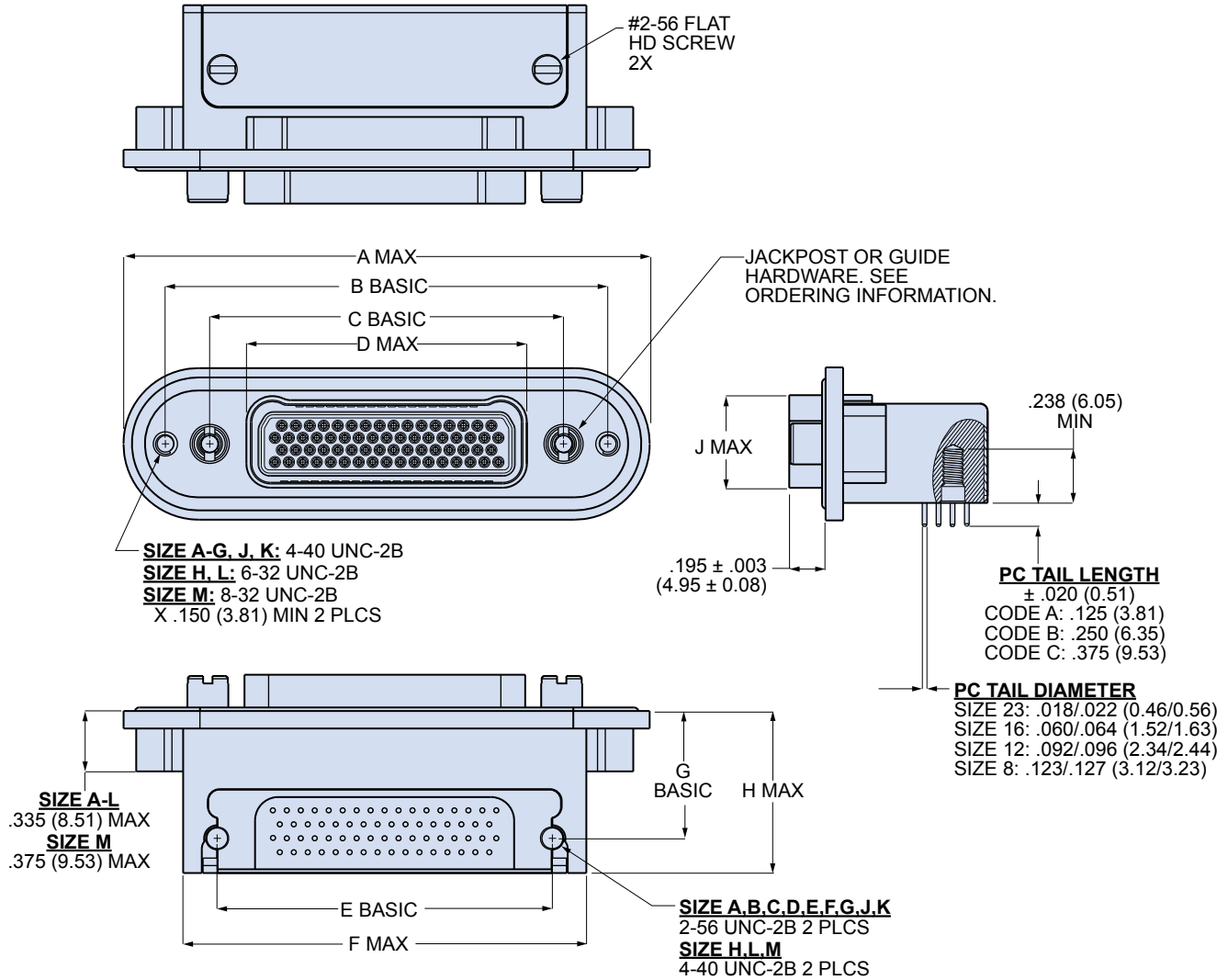

791-011P Dimensions

Shell Size	A Max		B Basic		C Basic		D Max		E Basic		F Max		G Basic		H Max		J Max	
	In.	mm.	In.	mm.	In.	mm.	In.	mm.	In.	mm.	In.	mm.	In.	mm.	In.	mm.	In.	mm.
A	1.565	39.75	1.150	29.21	.750	19.05	.490	12.45	.565	14.35	.990	25.15	.610	15.49	.725	18.42	.400	10.16
B	1.715	43.56	1.300	33.02	.900	22.86	.630	16.00	.715	18.16	1.140	28.96	.610	15.49	.725	18.42	.400	10.16
C	1.865	55.34	1.450	36.83	1.050	26.67	.780	19.81	.865	21.97	1.290	32.77	.610	15.49	.725	18.42	.400	10.16
D	1.940	49.28	1.525	38.74	1.125	28.58	.855	21.72	.965	24.51	1.365	34.67	.610	15.49	.725	18.42	.400	10.16
E	2.090	53.09	1.675	42.55	1.275	32.38	1.005	25.53	1.115	28.32	1.515	38.48	.610	15.49	.725	18.42	.400	10.16
F	2.240	56.60	1.825	46.36	1.425	36.20	1.155	29.34	1.265	32.13	1.665	42.29	.610	15.49	.725	18.42	.400	10.16
G	2.200	55.88	1.785	45.34	1.388	35.26	1.117	28.37	1.215	30.86	1.625	41.28	.682	17.37	.800	20.32	.490	12.45
H	2.835	72.01	2.375	60.34	1.900	48.26	1.507	38.28	1.800	45.72	2.175	55.25	.691	17.55	.880	22.35	.510	12.95
J	2.615	66.42	2.200	55.88	1.800	45.72	1.530	38.86	1.615	41.02	2.040	51.82	.610	15.49	.725	18.42	.400	10.16
K	2.990	75.95	2.575	65.41	2.175	55.25	1.905	48.39	2.015	51.18	2.415	61.34	.610	15.49	.725	18.42	.400	10.16
L	3.075	78.11	2.611	66.32	2.136	54.26	1.743	44.27	2.036	51.71	2.411	61.24	.691	17.55	.880	22.35	.510	12.95
M	3.345	84.96	2.824	71.73	2.200	55.88	1.804	45.82	2.200	55.88	2.580	66.53	.798	20.27	.995	25.27	.585	14.86

Panel Mount Printed Circuit Board Connectors

791-011P Panel Mount Receptacle Connectors with Right Angle PCB Pin Contacts

Recommended Panel Cutout

SHELL SIZES A-G, J, K

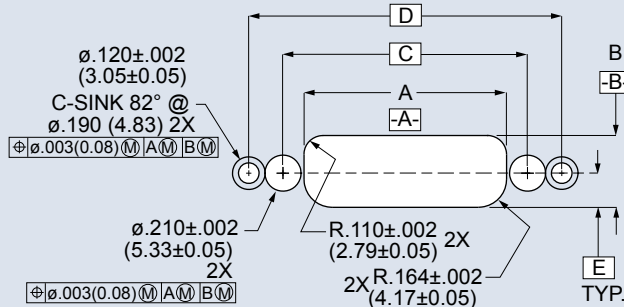

SHELL SIZES H, L

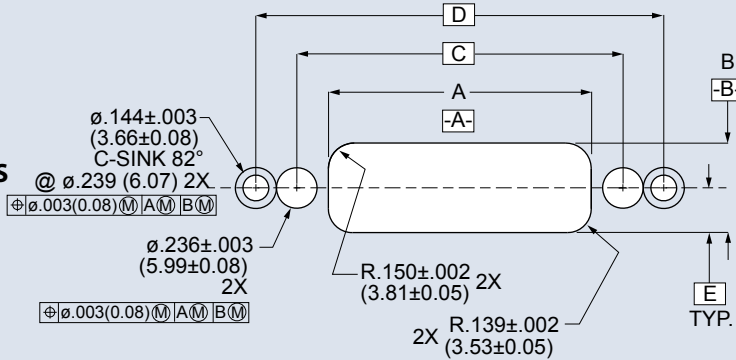

SHELL SIZE M

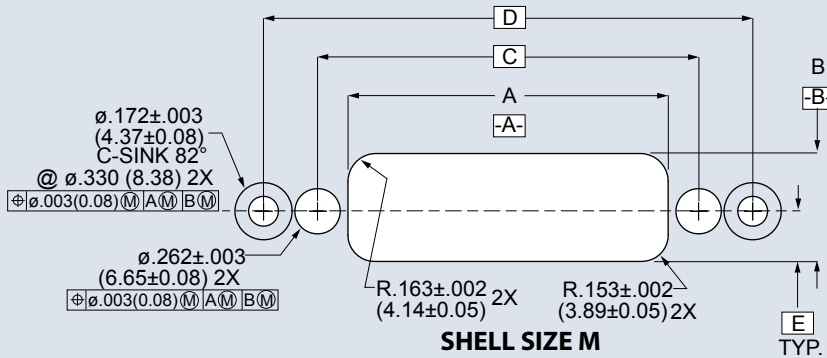

Application Notes

- Supplied with (2) flat head screws for panel mounting. 82° c-sink with reduced head diameter to fit recommended panel cutout. Slot drive, stainless steel.

2. Blind Mate Tolerances

Shell Size	Maximum allowable misalignment from centerline
A - G, J, K	.030 (0.76)
H, L	.040 (1.02)
M	.050 (1.27)

Shell Size	A ±.002(0.05)		B ±.002(0.05)		C Basic		D Basic		E Basic	
	In.	mm.	In.	mm.	In.	mm.	In.	mm.	In.	mm.
A	.505	12.83	.418	10.62	.750	19.50	1.150	29.21	.199	5.05
B	.655	16.64	.418	10.62	.900	22.86	1.300	33.02	.199	5.05
C	.805	20.45	.418	10.62	1.050	26.67	1.450	36.83	.199	5.05
D	.880	22.35	.418	10.62	1.125	28.58	1.525	38.74	.199	5.05
E	1.030	26.16	.418	10.62	1.275	32.39	1.675	42.55	.199	5.05
F	1.180	29.97	.418	10.62	1.425	36.20	1.825	46.36	.199	5.05
G	1.142	29.01	.506	12.85	1.388	35.25	1.786	45.34	.244	6.20
H	1.531	38.89	.521	13.23	1.900	48.26	2.375	60.34	.250	6.35
J	1.555	39.50	.418	10.62	1.800	45.72	2.200	55.88	.199	5.05
K	1.930	49.02	.418	10.62	2.175	55.25	2.575	65.41	.199	5.05
L	1.767	44.88	.521	13.23	2.136	54.26	2.611	66.32	.250	6.35
M	1.850	46.99	.623	15.82	2.200	55.88	2.824	71.73	.290	7.37

Float Mount Connectors

791-018S Float Mount Plug Connectors with Crimp-and-Poke Socket Contacts

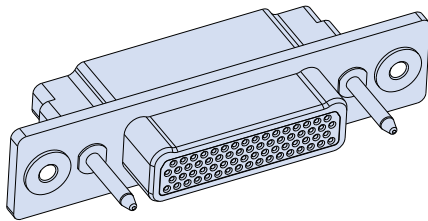

791-018S
Float Mount Plug

Harsh environment. Rugged construction. Ultriminiature.

Series 791 connectors are the next-generation higher density alternative to M24308 D Subminiature and other rack-and-panel connectors. Float bushings and guide pins for blind mate applications. Dual lobe shell, mating receptacle has recessed pins to prevent scooping damage. Aluminum shell, thermoplastic insulator, gold-plated copper alloy contacts. 5A to 46A current rating depending on contact size.

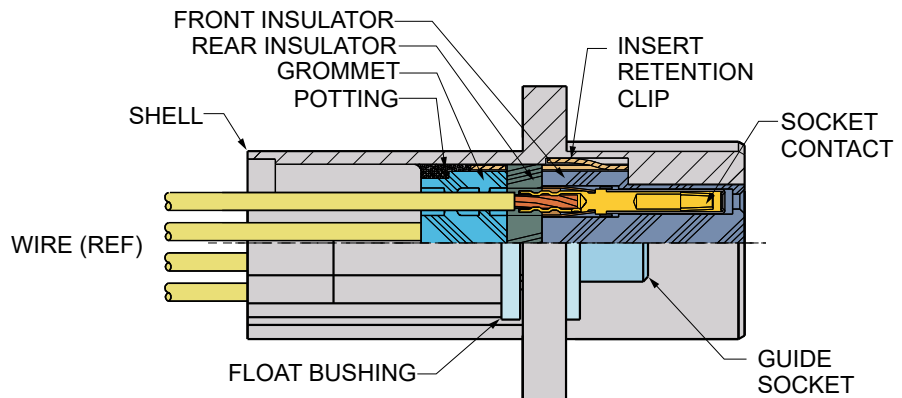

RELIABLE DESIGN

- 100% scoop-proof
- Snap-in, rear release contacts
- EMI shell-to-shell continuity

VERSATILE

- Wide range of configurations
- Signal, power, RF, datalink
- Blind mate

HARSH ENVIRONMENT

- Humidity, water ingress
- Shock and vibration
- Temperature extremes
- Corrosion resistance
- High altitude

SIZE AND WEIGHT SAVING

- High density

How To Order

Sample Part Number	791-018S	F-5P5	M	G
Product	791-018S Float mount plug, socket contacts, crimp type			
Arrangement Number (Shell Size - Insert Arr.)	See Table 2			
Shell Finish	M = Electroless Nickel MT = Nickel-PTFE ZR = Black Zinc-Nickel			
Hardware Option (Table 1)	N = No hardware) G = Male guide pin B = Female guide bushing			

Wire Accommodation

Contact Size	Wire Range AWG
23	22 – 28
16	16 – 20
12	12 – 14
8	8

Specifications

- Operating temperature: -65 to +150°C
- Current and voltage ratings:

Contact Size	Amps, max.	DWV Vac rms
23	5	750
16	13	1800
12	23	1800
8	46	1800
- Shock: EIA-364-27 condition D
- Vibration: EIA-364-28 condition V, letter E
- See pages 8-10 for Series 79 Product Specifications (ref: 799-008)

Construction

- Shell: aluminum alloy
- Insulators: high grade rigid dielectric
- Contacts: copper alloy, 50 microinches gold over nickel plating
- Socket contact hood: stainless steel, passivated
- Wire grommet: fluorosilicone blend
- Contact retention clip, insert retention clip: beryllium copper
- Hardware: stainless steel, passivated

Float Mount Connectors

791-018S Float Mount Plug Connectors with Crimp-and-Poke Socket Contacts

Table 1 Hardware Option











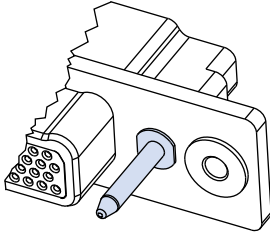
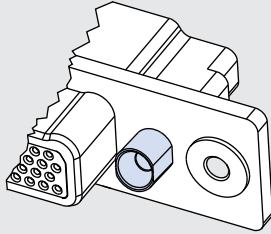











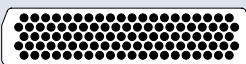















 <p>N No Hardware</p> <p>Connector supplied with threaded holes, .150 (3.8) minimum depth. Shell sizes A-G, J, K have 6-32 UNC-2B thread, sizes H and L have 8-32 UNC-2B thread. Size M has 10-32 UNF-2B thread.</p>	 <p>G Guide Pins</p> <p>Guide pins for blind mating applications. Use with guide bushing on mating connector. 300 series stainless steel, non-removable.</p>	 <p>B Guide Bushing</p> <p>Female guide bushings for blind mating applications. Use with guide pin on mating connector. 300 series stainless steel, non-removable.</p>
---	---	---

Table 2 Arrangement Number

Change the "P" to a "W" in any combo arrangement to delete power contacts. For example, arrangement **H-10P4** is supplied with a total of 10 contacts including (4) #12 power pins and (6) signal pins. Arrangement **H-10W4** is supplied with (6) signal pins and no power pins. Order coax contacts separately.

Arrangements with Size #23 Contacts	Arrangements with Size #16 Contacts	Arrangements with Size #12 Contacts
 A-5 5 #23  B-9 9 #23  C-13 13 #23  D-15 15 #23  E-19 19 #23  F-23 23 #23  G-33 33 #23  H-66 66 #23  J-33 33 #23  K-43 43 #23  L-78 78 #23  M-102 102 #23	 B-2P2 2 #16  D-3P3 3 #16  D-7P2 5 #23, 2 #16  E-11P2 9 #23, 2 #16  E-7P3 4 #23, 3 #16  F-14P3 11 #23, 3 #16  F-15P2 13 #23, 2 #16  F-5P5 5 #16  H-29P7 22 #23, 7 #16  H-54P2 52 #23, 2 #16  J-17P4 13 #23, 4 #16  J-25P2 23 #23, 2 #16  J-7P7 7 #16  K-27P4 23 #23, 4 #16  K-35P2 33 #23, 2 #16  K-9P9 9 #16  M-17P17 17 #16	 G-13P2 11 #23, 2 #12  G-3P3 3 #12  G-21P1 20 #23, 1 #12  H-10P4 6 #23, 4 #12  H-36P2 34 #23, 2 #12  H-5P5 5 #12  L-6P6 6 #12 <p>Arrangements with Size #8 Contacts</p>  M-4P4 Supplied with 4 #8 Power Contacts  M-4W4 Contacts ordered separately, dielectric insert  M-4G4 contacts ordered separately, metal insert

Float Mount Connectors

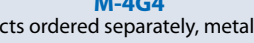
791-018S Float Mount Plug Connectors with Crimp-and-Poke Socket Contacts

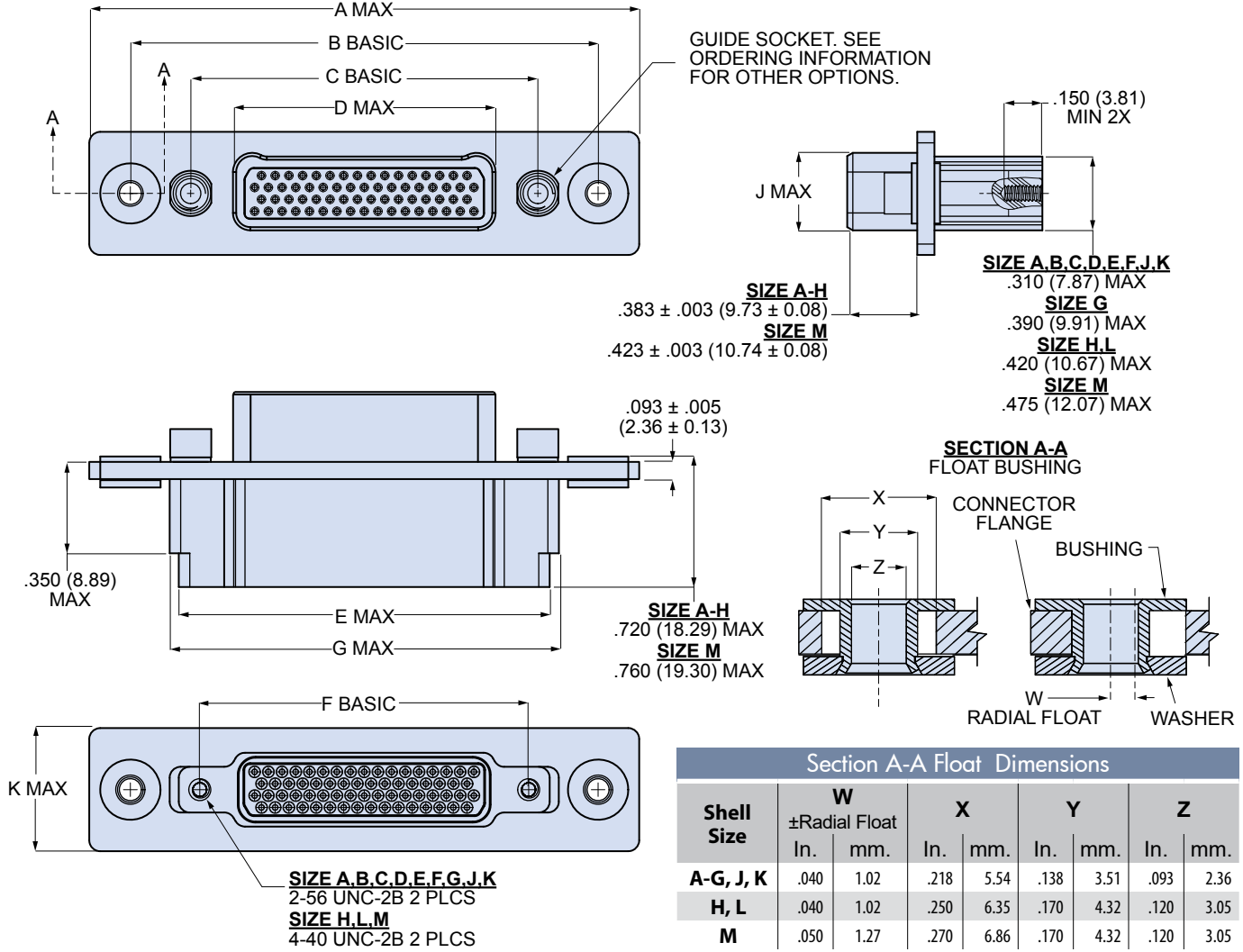

791-018S Dimensions

Shell Size	A Max		B Basic		C Basic		D Max		E Max		F Basic		G Max		J Max		K Max	
	In.	mm.	In.	mm.	In.	mm.	In.	mm.	In.	mm.	In.	mm.	In.	mm.	In.	mm.	In.	mm.
A	1.785	45.34	1.365	34.67	.750	19.05	.410	10.41	.760	19.30	.565	14.35	.965	24.51	.320	8.13	.568	14.43
B	1.935	49.15	1.515	38.48	.900	22.86	.560	14.22	.910	21.11	.715	18.16	1.115	28.32	.320	8.13	.568	14.43
C	2.085	52.96	1.665	42.29	1.050	26.67	.710	18.03	1.060	26.92	.865	21.97	1.265	32.13	.320	8.13	.568	14.43
D	2.160	54.86	1.740	44.20	1.125	28.58	.785	19.94	1.160	29.46	.965	24.51	1.340	34.04	.320	8.13	.568	14.43
E	2.310	58.67	1.890	48.01	1.275	32.38	.935	23.75	1.310	33.27	1.115	28.32	1.490	37.85	.320	8.13	.568	14.43
F	2.460	62.48	2.040	51.82	1.425	36.20	1.085	27.56	1.460	37.08	1.265	32.13	1.640	41.66	.320	8.13	.568	14.43
G	2.421	61.49	2.003	50.88	1.388	35.26	1.047	26.59	1.410	35.81	1.215	30.86	1.615	41.02	.415	10.57	.656	16.66
H	3.010	76.45	2.560	65.02	1.900	48.26	1.437	36.50	2.045	51.94	1.800	45.72	2.130	54.10	.430	10.92	.674	17.12
J	2.835	72.01	2.415	61.34	1.800	45.72	1.460	37.08	1.810	45.97	1.615	41.02	2.015	51.18	.320	8.13	.568	14.43
K	3.210	81.53	2.790	70.87	2.175	55.25	1.835	46.61	2.210	56.13	2.015	51.18	2.390	60.71	.320	8.13	.568	14.43
L	3.246	82.45	2.796	71.02	2.136	54.25	1.673	42.49	2.281	57.94	2.036	51.71	2.366	60.10	.433	10.93	.674	17.12
M	3.442	87.43	2.940	74.68	2.200	55.88	1.734	44.04	2.445	62.10	2.200	50.80	2.470	62.74	.512	13.00	.754	19.15

Float Mount Connectors

791-018S Float Mount Plug Connectors with Crimp-and-Poke Socket Contacts

Recommended Panel Cutout for Float Mount Connectors

Panel Cutout for Shell Sizes A, B, C, D, E, F, G, J, K

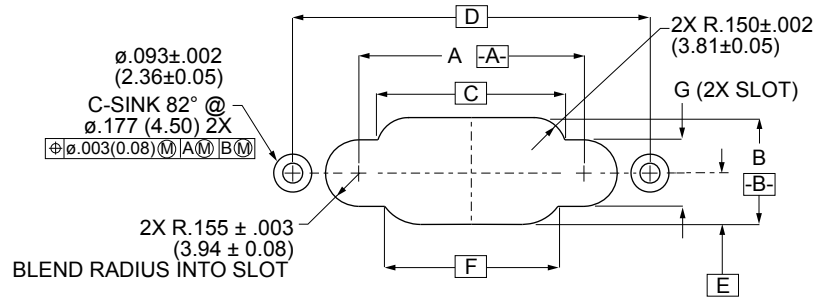

Panel Cutout for Shell Sizes H, L

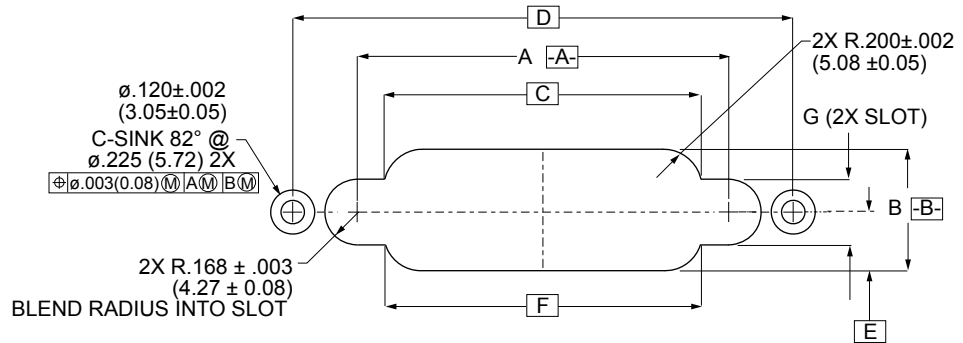

Panel Cutout for Shell Size M

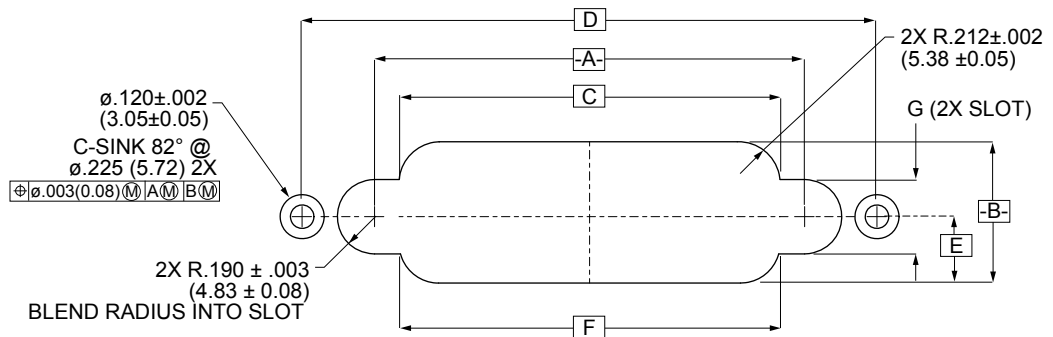

Shell Size	A ±.002(0.05)		B ±.002(0.05)		C Basic		D Basic		E Basic		F Basic		G ±.003(0.08)	
	In.	mm.	In.	mm.	In.	mm.	In.	mm.	In.	mm.	In.	mm.	In.	mm.
A	.750	19.05	.498	12.65	.571	14.50	1.365	34.67	.239	6.07	.507	12.88	.310	7.87
B	.900	22.86	.498	12.65	.721	18.31	1.515	38.48	.239	6.07	.657	16.69	.310	7.87
C	1.050	26.67	.498	12.65	.871	22.12	1.665	42.29	.239	6.07	.807	20.50	.310	7.87
D	1.125	28.58	.498	12.65	.946	24.03	1.740	44.20	.239	6.07	.882	22.40	.310	7.87
E	1.275	32.39	.498	12.65	1.096	27.84	1.890	48.01	.239	6.07	1.032	26.21	.310	7.87
F	1.425	36.20	.498	12.65	1.246	31.65	2.040	51.82	.239	6.07	1.182	30.02	.310	7.87
G	1.388	35.26	.586	14.88	1.223	31.06	2.003	50.88	.283	7.19	1.194	30.33	.310	7.87
H	1.900	48.26	.620	15.75	1.617	41.07	2.560	65.02	.300	7.62	1.610	40.89	.336	8.53
J	1.800	45.72	.498	12.65	1.621	41.17	2.415	61.34	.239	6.07	1.557	39.55	.310	7.87
K	2.175	55.25	.498	12.65	1.996	50.70	2.790	70.87	.239	6.07	1.932	49.07	.310	7.87
L	2.136	54.25	.620	15.75	1.853	47.07	2.796	71.02	.300	7.62	1.846	46.89	.336	8.53
M	2.200	55.88	.723	18.36	1.948	49.48	2.940	74.68	.340	8.64	1.935	49.15	.380	9.65

Float Mount Connectors

791-017P Float Mount Receptacle Connectors with Crimp-and-Poke Pin Contacts

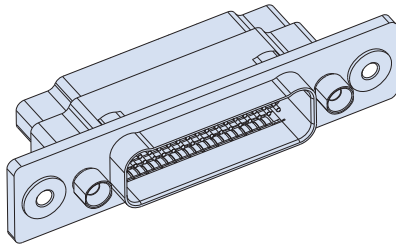

791-017P
Float Mount Receptacle

RELIABLE DESIGN

- 100% scoop-proof
- Snap-in, rear release contacts
- EMI shell-to-shell continuity

VERSATILE

- Wide range of configurations
- Signal, power, RF, datalink
- Blind mate

HARSH ENVIRONMENT

- Humidity, water ingress
- Shock and vibration
- Temperature extremes
- Corrosion resistance
- High altitude

SIZE AND WEIGHT SAVING

- High density

Harsh environment. Rugged construction. Ultraminiature.

Series 791 connectors are the next-generation higher density alternative to M24308 D Subminiature and other rack-and-panel connectors. Dual lobe shell, recessed pins to prevent scooping damage. Aluminum shell, thermoplastic insulator, gold-plated copper alloy contacts. Float bushings for blind mating. 5A to 46A current rating depending on contact size.

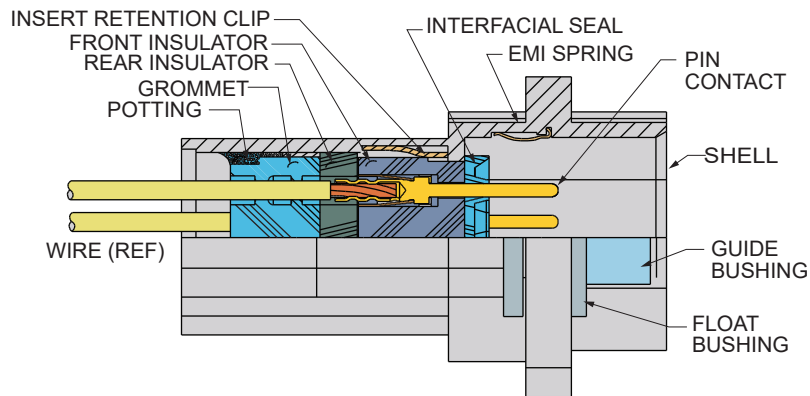

How To Order

Sample Part Number	791-017P	H-10W4	M	E	B
Product	791-017P Float mount receptacle, pin contacts, crimp type				
Arrangement Number (Shell Size - Insert Arr.)	See Table 2				
Shell Finish	M = Electroless Nickel MT = Nickel-PTFE ZR = Black Zinc-Nickel				
EMI Spring	E = EMI spring N = No EMI spring				
Hardware Option (Table 1)	N = No hardware G = Male guide pin B = Female guide bushing				

Wire Accommodation

Contact Size	Wire Range AWG
23	22 – 28
16	16 – 20
12	12 – 14
8	8

Specifications

- Operating temperature: -65 to +150°C
- Current and voltage ratings:

Contact Size	Amps, max.	DWV Vac rms
23	5	750
16	13	1800
12	23	1800
8	46	1800
- Shock: EIA-364-27 condition D
- Vibration: EIA-364-28 condition V, letter E
- See pages 8-10 for Series 79 Product Specifications (ref: 799-008)

Construction

- Shell: aluminum alloy
- Insulators: high grade rigid dielectric
- Contacts: copper alloy, 50 microinches gold over nickel plating
- Socket contact hood: stainless steel, passivated
- Wire grommet: fluorosilicone blend
- Interfacial seal: fluorosilicone blend
- EMI spring: beryllium copper, nickel plated
- Contact retention clip, insert retention clip: beryllium copper
- Hardware: stainless steel, passivated

Float Mount Connectors

791-017P Float Mount Receptacle Connectors with Crimp-and-Poke Pin Contacts

Table 1 Hardware Option











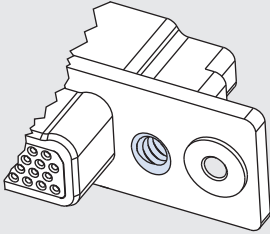
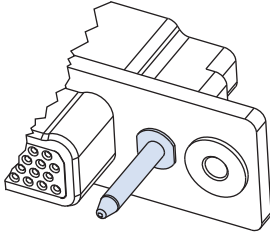
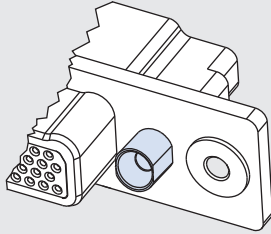

























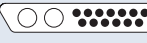

 <p>N No Hardware</p> <p>Connector supplied with threaded holes, .150 (3.8) minimum depth. Shell sizes A-G, J, K have 6-32 UNC-2B thread, sizes H and L have 8-32 UNC-2B thread. Size M has 10-32 UNF-2B thread.</p>	 <p>G Guide Pins</p> <p>Guide pins for blind mating applications. Use with guide bushing on mating connector. 300 series stainless steel, non-removable.</p>	 <p>B Guide Bushing</p> <p>Female guide bushings for blind mating applications. Use with guide pin on mating connector. 300 series stainless steel, non-removable.</p>
---	---	---

Table 2 Arrangement Number

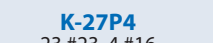
Change the "P" to a "W" in any combo arrangement to delete power contacts. For example, arrangement **H-10P4** is supplied with a total of 10 contacts including (4) #12 power pins and (6) signal pins. Arrangement **H-10W4** is supplied with (6) signal pins and no power pins. Order coax contacts separately.

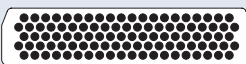
Arrangements with Size #23 Contacts	Arrangements with Size #16 Contacts	Arrangements with Size #12 Contacts
 A-5 5 #23  B-9 9 #23  C-13 13 #23	 B-2P2 2 #16  D-3P3 3 #16  D-7P2 5 #23, 2 #16	 G-13P2 11 #23, 2 #12  G-3P3 3 #12  G-21P1 20 #23, 1 #12
 D-15 15 #23  E-19 19 #23	 E-11P2 9 #23, 2 #16  E-7P3 4 #23, 3 #16  F-14P3 11 #23, 3 #16	 H-10P4 6 #23, 4 #12  H-36P2 34 #23, 2 #12
 F-23 23 #23  G-33 33 #23	 F-15P2 13 #23, 2 #16  F-5P5 5 #16	 H-5P5 5 #12
 H-66 66 #23  J-33 33 #23	 H-29P7 22 #23, 7 #16  H-54P2 52 #23, 2 #16	 L-6P6 6 #12
 K-43 43 #23	 J-17P4 13 #23, 4 #16  J-25P2 23 #23, 2 #16	<p>Arrangements with Size #8 Contacts</p>  M-4P4 Supplied with 4 #8 Power Contacts
 L-78 78 #23	 J-7P7 7 #16  K-27P4 23 #23, 4 #16	 M-4W4 Contacts ordered separately, dielectric insert
 M-102 102 #23	 K-35P2 33 #23, 2 #16  K-9P9 9 #16  M-17P17 17 #16	 M-4G4 contacts ordered separately, metal insert

Float Mount Connectors

791-017P Float Mount Receptacle Connectors with Crimp-and-Poke Pin Contacts

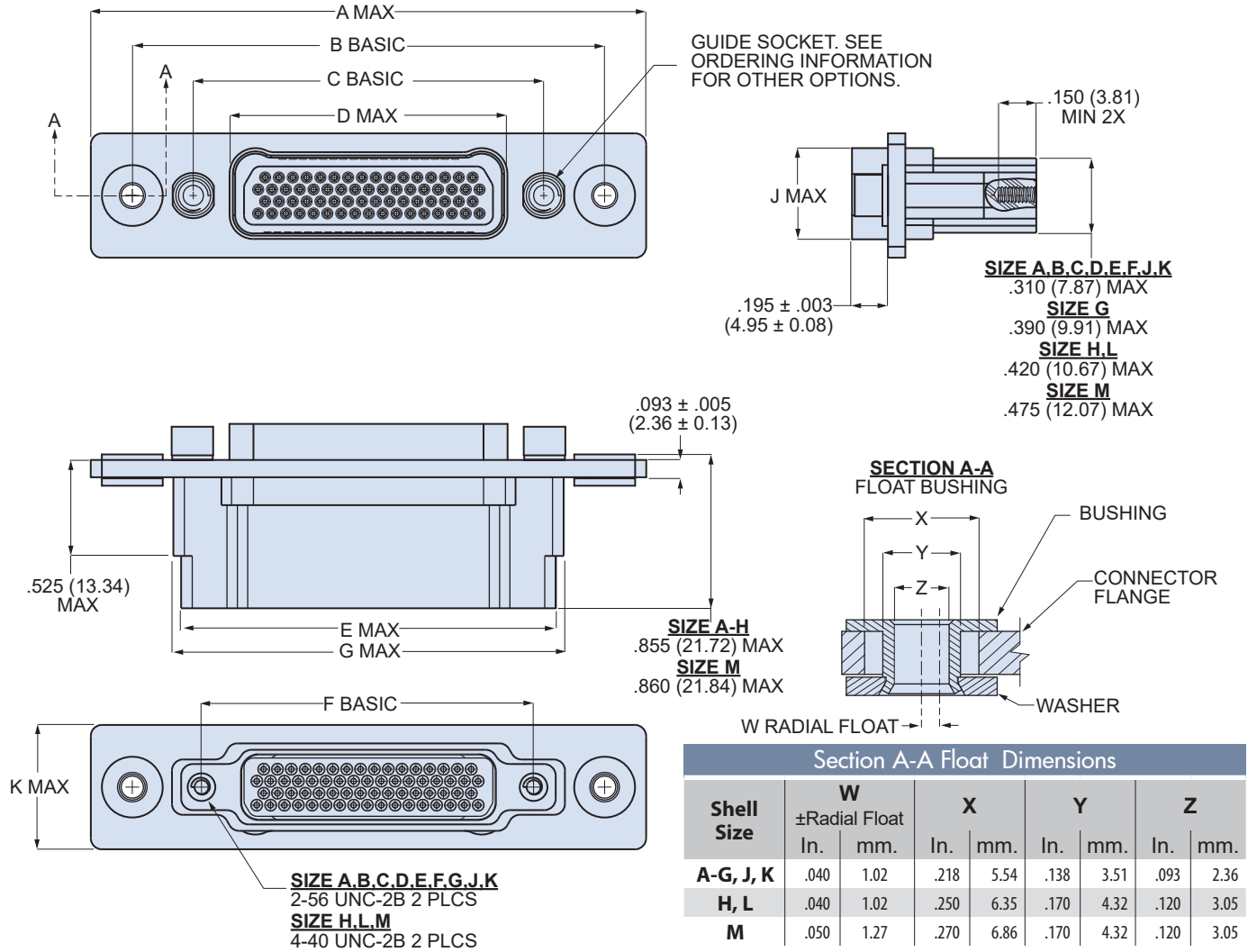

791-017P Dimensions

Shell Size	A Max		B Basic		C Basic		D Max		E Max		F Basic		G Max		J Max		K Max	
	In.	mm.	In.	mm.	In.	mm.	In.	mm.	In.	mm.	In.	mm.	In.	mm.	In.	mm.	In.	mm.
A	1.785	45.34	1.365	34.67	.750	19.05	.490	12.45	.760	19.30	.565	14.35	.965	24.51	.400	10.16	.568	14.43
B	1.935	49.15	1.515	38.48	.900	22.86	.630	16.00	.910	21.11	.715	18.16	1.115	28.32	.400	10.16	.568	14.43
C	2.085	52.96	1.665	42.29	1.050	26.67	.780	19.81	1.060	26.92	.865	21.97	1.265	32.13	.400	10.16	.568	14.43
D	2.160	54.86	1.740	44.20	1.125	28.58	.855	21.72	1.160	29.46	.965	24.51	1.340	34.04	.400	10.16	.568	14.43
E	2.310	58.67	1.890	48.01	1.275	32.38	1.005	25.53	1.310	33.27	1.115	28.32	1.490	37.85	.400	10.16	.568	14.43
F	2.460	62.48	2.040	51.82	1.425	36.20	1.155	29.34	1.460	37.08	1.265	32.13	1.640	41.66	.400	10.16	.568	14.43
G	2.421	61.49	2.003	50.88	1.388	35.26	1.117	28.37	1.410	35.81	1.215	30.86	1.615	41.02	.490	12.45	.656	16.66
H	3.010	76.45	2.560	65.02	1.900	48.26	1.507	38.28	2.045	51.94	1.800	45.72	2.130	54.10	.510	12.95	.674	17.12
J	2.835	72.01	2.415	61.34	1.800	45.72	1.530	38.86	1.810	45.97	1.615	41.02	2.015	51.18	.400	10.16	.568	14.43
K	3.210	81.53	2.790	70.87	2.175	55.25	1.905	48.39	2.210	56.13	2.015	51.18	2.390	60.71	.400	10.16	.568	14.43
L	3.246	82.45	2.796	71.02	2.136	54.25	1.743	44.27	2.281	57.94	2.036	51.71	2.366	66.10	.510	12.95	.674	17.12
M	3.442	87.43	2.940	74.68	2.200	55.88	1.804	45.82	2.445	62.10	2.200	55.88	2.470	62.74	.585	14.86	.754	19.15

Blind Mate Float Mount Connectors

791-017P Float Mount Receptacle Connectors with Crimp-and-Poke Pin Contacts

Recommended Panel Cutout for Float Mount Connectors

Panel Cutout for Shell Sizes **A, B, C, D, E, F, G, J, K**

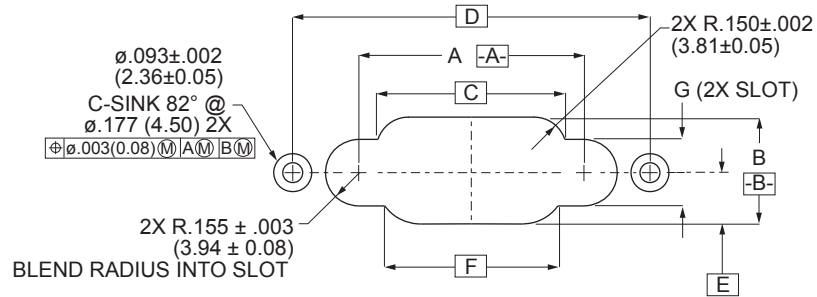

Panel Cutout for Shell Sizes **H, L**

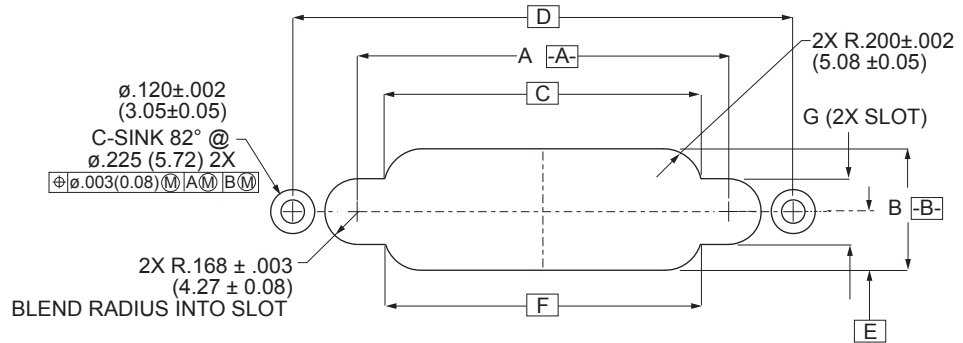

Panel Cutout for Shell Size **M**

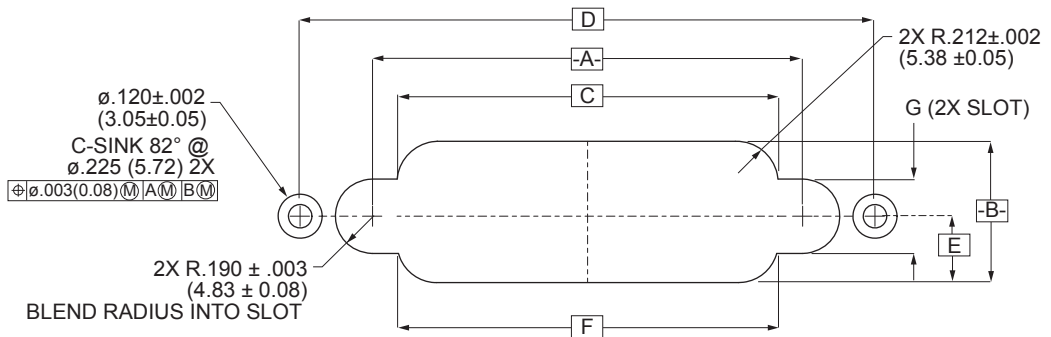

Shell Size	A ±.002(0.05)		B ±.002(0.05)		C Basic		D Basic		E Basic		F Basic		G ±.003(0.08)	
	In.	mm.	In.	mm.	In.	mm.	In.	mm.	In.	mm.	In.	mm.	In.	mm.
A	.750	19.05	.498	12.65	.571	14.50	1.365	34.67	.239	6.07	.507	12.88	.310	7.87
B	.900	22.86	.498	12.65	.721	18.31	1.515	38.48	.239	6.07	.657	16.69	.310	7.87
C	1.050	26.67	.498	12.65	.871	22.12	1.665	42.29	.239	6.07	.807	20.50	.310	7.87
D	1.125	28.58	.498	12.65	.946	24.03	1.740	44.20	.239	6.07	.882	22.40	.310	7.87
E	1.275	32.39	.498	12.65	1.096	27.84	1.890	48.01	.239	6.07	1.032	26.21	.310	7.87
F	1.425	36.20	.498	12.65	1.246	31.65	2.040	51.82	.239	6.07	1.182	30.02	.310	7.87
G	1.388	35.26	.586	14.88	1.223	31.06	2.003	50.88	.283	7.19	1.194	30.33	.310	7.87
H	1.900	48.26	.620	15.75	1.617	41.07	2.560	65.02	.300	7.62	1.610	40.89	.336	8.53
J	1.800	45.72	.498	12.65	1.621	41.17	2.415	61.34	.239	6.07	1.557	39.55	.310	7.87
K	2.175	55.25	.498	12.65	1.996	50.70	2.790	70.87	.239	6.07	1.932	49.07	.310	7.87
L	2.136	54.25	.620	15.75	1.853	47.07	2.796	71.02	.300	7.62	1.846	46.89	.336	8.53
M	2.200	55.88	.723	18.36	1.948	49.48	2.940	74.68	.340	8.64	1.935	49.15	.380	9.65

Hermetic Receptacle Connectors

791-044 Hermetic Receptacle Connectors with Solder Cup or PC Tail Contacts

Glass-to-metal seal. Solder cup or PC tail. Blind Mate. Series 791 hermetic connectors are the next-generation higher density alternative to M24308 D Subminiature connectors. Dual lobe shell with recessed pin contacts to prevent scooping damage. 1×10^{-5} cc/sec helium leak rate. Stainless steel shell, fused vitreous dielectric insert, gold-plated nickel-iron alloy contacts, fluorosilicone interfacial seal.

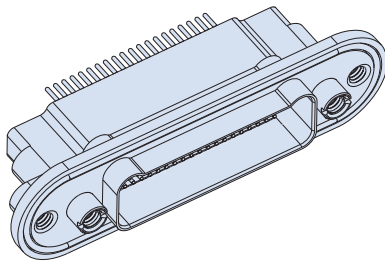

791-044
Hermetic Receptacle

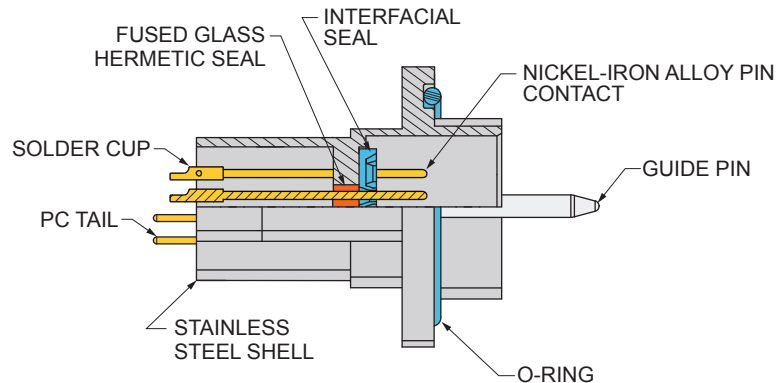

RELIABLE DESIGN

- Glass-to-metal seal
- 100% scoop-proof
- Stainless steel shell

VERSATILE

- Wide range of configurations
- Signal, power
- Blind mate

HARSH ENVIRONMENT

- Humidity, water ingress
- Shock and vibration
- Temperature extremes
- Corrosion resistance
- High altitude

SIZE AND WEIGHT SAVING

- High density

How To Order

<i>Sample Part Number</i>	791-044	Z1	H-29P7	P	P
Product	Panel mount hermetic receptacle connector				
Shell Finish	Z1 = Passivated SST ZL = Nickel-plated SST				
Arrangement Number (Shell Size-Insert Arr.)	See Table 2				
Contact Type	C = Pin Contacts, PC tail P = Pin Contacts, Solder Cup				
Hardware Option (Table 1)	N = No hardware P = Jackpost G = Male guide pin S = Female guide bushing				

Specifications

- **Hermeticity:** 10^{-5} cm³/s helium leak rate at 1ATM pressure differential
- **Operating temperature:** -65 to +150°C
- **Dielectric withstanding voltage**
Size #23 contacts: 500 Vac rms
#12, #16, #8: 1800 Vac rms
- **Current rating:**
Size 23 contacts: 3A
Size 16 contacts: 10A
Size 12 contacts: 17A
- **Shock:** EIA-364-27 condition D
- **Vibration:** EIA-364-28 condition V, letter E
- See pages 8-10 for additional specifications

Construction

- **Shell:** 300 series stainless steel
- **Insulator:** vitreous glass
- **Contacts:** nickel-iron alloy, 50 microinches gold over nickel plating
- **Hardware:** stainless steel, passivated
- **O-ring:** fluorosilicone

Hermetic Receptacle Connectors

791-044 Hermetic Receptacle Connectors with Solder Cup or PC Tail Contacts

Table 1 Hardware Option











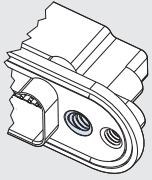
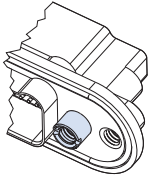
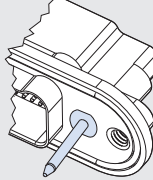
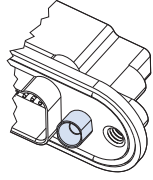























 <p>N No Hardware</p> <p>Connector supplied with threaded holes, .150 (3.8) minimum depth. Shell sizes A-G, J, K have 6-32 UNC-2B thread, sizes H and L have 8-32 UNC-2B thread. Size M has 10-32 UNF-2B thread.</p>	 <p>P Jackposts</p> <p>Non-removable female jackpost. Shell sizes A-G, J, K have 4-40 UNC-2B thread, sizes H and L have 6-32 UNC-2B thread. Size M has 8-32 UNC-2B thread. 300 series stainless steel, passivated.</p>	 <p>G Guide Pins</p> <p>Non-removable, 300 series stainless steel guide pins for blind mating applications. Use with guide bushing on mating connector.</p>	 <p>S Guide Bushing</p> <p>Non-removable, 300 series stainless steel female guide bushings for blind mating applications. Use with guide pin on mating connector.</p>
---	---	---	--

Table 2 Arrangement Number

Arrangements with Size #23 Contacts	Arrangements with Size #16 Contacts	Arrangements with Size #12 Contacts
 A-5 5 #23	 B-2P2 2 #16	 G-13P2 11 #23, 2 #12
 B-9 9 #23	 D-3P3 3 #16	 G-3P3 3 #12
 C-13 13 #23	 D-7P2 5 #23, 2 #16	 H-10P4 6 #23, 4 #12
 D-15 15 #23	 E-7P3 4 #23, 3 #16	 H-36P2 34 #23, 2 #12
 E-19 19 #23	 F-14P3 11 #23, 3 #16	 H-5P5 5 #12
 F-23 23 #23	 F-15P2 13 #23, 2 #16	 L-6P6 6 #12
 G-33 33 #23	 F-5P5 5 #16	 J-17P4 13 #23, 4 #16
 H-66 66 #23	 H-29P7 22 #23, 7 #16	 J-25P2 23 #23, 2 #16
 J-33 33 #23	 H-54P2 52 #23, 2 #16	 K-27P4 23 #23, 4 #16
 K-43 43 #23	 J-7P7 7 #16	 K-35P2 33 #23, 2 #16
 L-78 78 #23	 K-9P9 9 #16	 M-17P17 17 #16
 M-102 102 #23		

Hermetic Receptacle Connectors

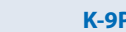
791-044 Hermetic Receptacle Connectors with Solder Cup or PC Tail Contacts

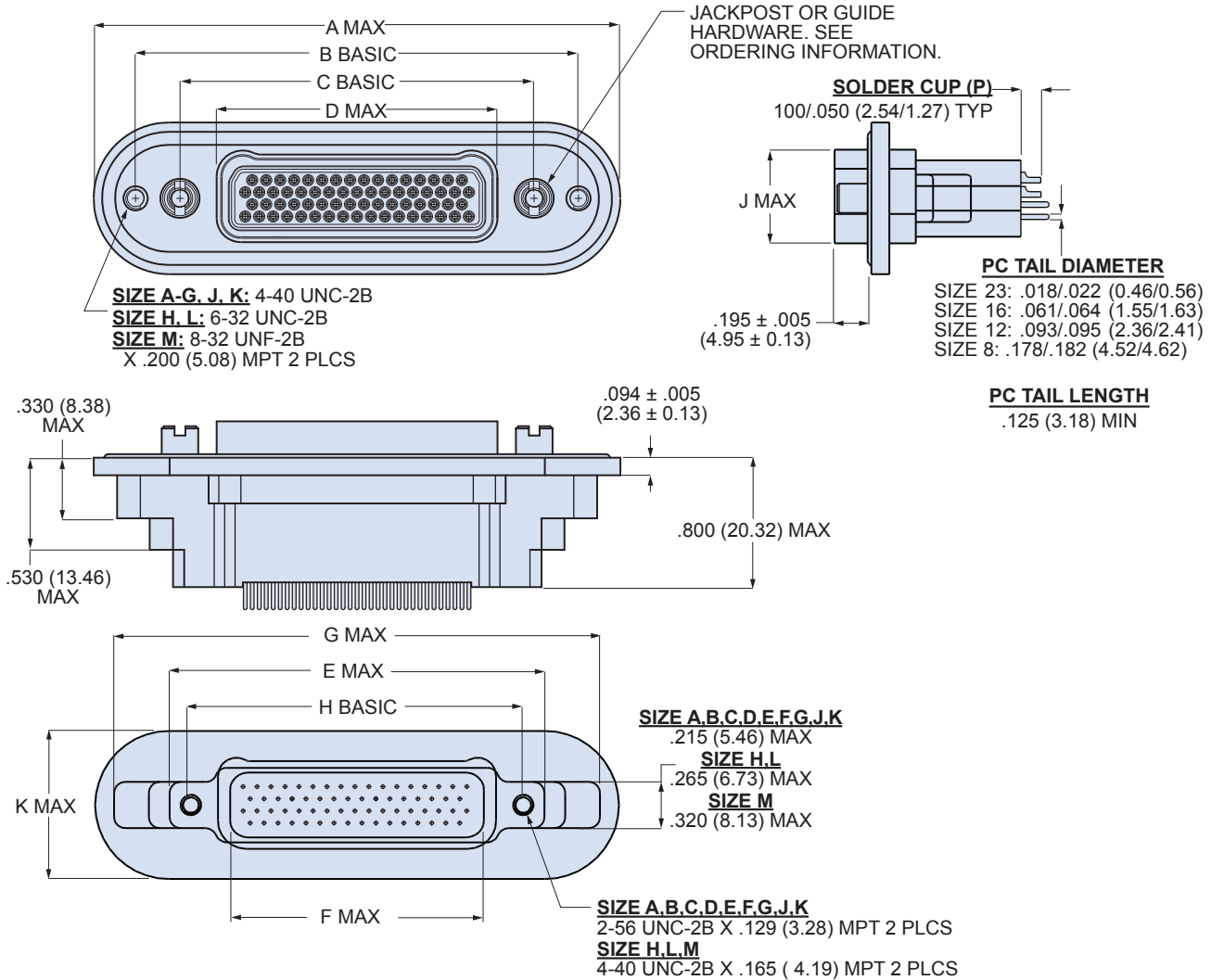

791-044 Dimensions

Shell Size	A Max		B Basic		C Basic		D Max		E Max		F Max		G Max		H Basic		J Max		K Max	
	In.	mm.	In.	mm.	In.	mm.	In.	mm.	In.	mm.	In.	mm.	In.	mm.	In.	mm.	In.	mm.	In.	mm.
A	1.750	44.45	1.300	33.02	.750	19.05	.490	12.45	.760	19.30	.350	8.89	1.500	38.10	.565	14.35	.410	10.41	.715	18.16
B	1.950	49.53	1.475	37.47	.900	22.86	.630	16.00	.910	23.11	.500	12.70	1.700	43.18	.715	18.16	.410	10.41	.715	18.16
C	2.025	51.44	1.600	40.64	1.050	26.67	.780	19.81	1.060	26.92	.650	16.51	1.800	45.72	.865	21.97	.410	10.41	.715	18.16
D	2.125	53.98	1.700	43.18	1.125	28.58	.860	21.84	1.160	29.46	.750	19.05	1.900	48.26	.965	24.51	.410	10.41	.715	18.16
E	2.325	59.06	1.800	45.72	1.275	32.39	1.010	25.65	1.310	33.27	.900	22.86	2.100	53.34	1.115	28.32	.410	10.41	.715	18.16
F	2.325	59.06	1.925	48.90	1.425	36.20	1.160	29.46	1.460	37.08	1.050	26.67	2.100	53.34	1.265	32.13	.410	10.41	.715	18.16
G	2.500	63.50	2.000	50.80	1.388	35.26	1.117	28.37	1.410	35.81	1.020	25.91	2.250	57.15	1.215	30.86	.490	12.45	.800	20.32
H	3.050	77.47	2.500	63.50	1.900	48.26	1.507	38.28	2.045	51.94	1.385	35.18	2.850	72.39	1.800	45.72	.510	12.95	.820	20.83
J	2.915	74.04	2.400	60.96	1.800	45.72	1.530	38.86	1.810	45.97	1.405	35.69	2.650	67.31	1.615	41.02	.410	10.41	.715	18.16
K	3.110	78.99	2.675	67.95	2.175	55.25	1.910	48.51	2.210	56.13	1.805	45.85	2.900	73.66	2.015	51.18	.410	10.41	.715	18.16
L	3.250	82.55	2.700	68.58	2.136	54.25	1.743	44.27	2.281	57.9	1.625	41.28	3.100	78.74	2.036	51.71	.510	12.95	.820	20.83
M	3.375	85.73	2.870	72.90	2.200	55.88	1.804	45.82	2.485	63.12	1.690	42.93	3.200	81.28	2.200	55.88	.600	15.24	.950	24.13

Hermetic Receptacle Connectors

791-044 Hermetic Receptacle Connectors with Solder Cup or PC Tail Contacts

Recommended Panel Cutout for Hermetic Rear Panel Mount Receptacles

Panel Cutout for Shell Sizes **A, B, C, D, E, F, G, J, K**

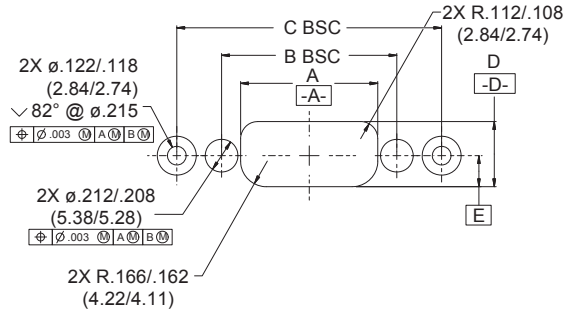

Panel Cutout for Shell Sizes **H, L**

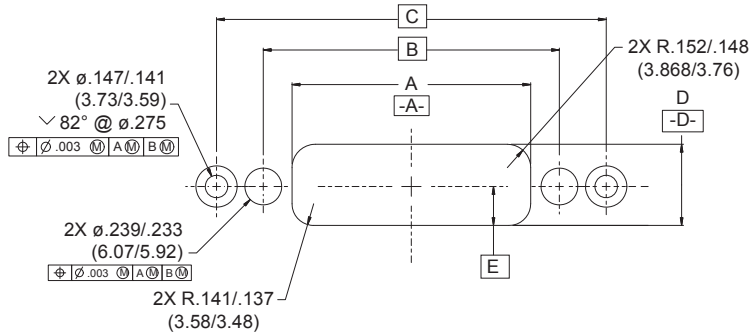

Panel Cutout for Shell Size **M**

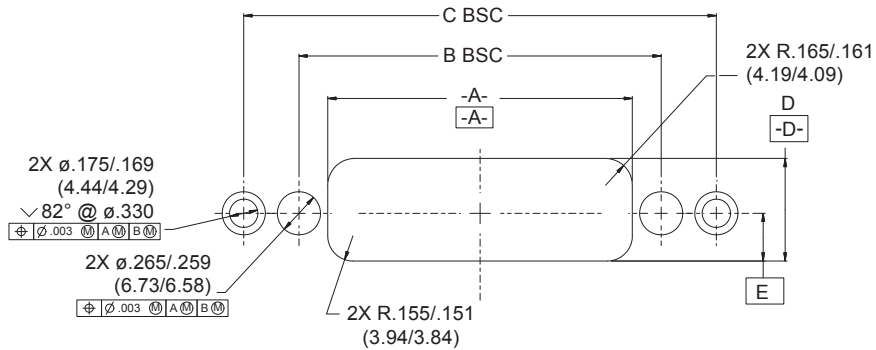

Shell Size	A ±.002(0.05)		B		C		D ±.002(0.05)		E	
	In.	mm.	In.	mm.	In.	mm.	In.	mm.	In.	mm.
A	.505	12.83	.750	19.05	1.300	33.02	.418	10.62	.199	5.05
B	.655	16.64	.900	22.86	1.475	37.47	.418	10.62	.199	5.05
C	.805	20.45	1.050	26.67	1.600	40.64	.418	10.62	.199	5.05
D	.880	22.35	1.125	28.58	1.700	43.18	.418	10.62	.199	5.05
E	1.030	26.16	1.275	32.39	1.800	45.72	.418	10.62	.199	5.05
F	1.180	29.97	1.425	36.20	1.925	48.90	.418	10.62	.199	5.05
G	1.142	29.01	1.388	35.26	2.000	50.80	.506	12.85	.244	6.19
H	1.531	38.89	1.900	48.26	2.500	63.50	.521	13.23	.250	6.35
J	1.555	39.50	1.800	45.72	2.400	60.96	.418	10.62	.199	5.05
K	1.930	49.02	2.175	55.25	2.675	67.95	.418	10.62	.199	5.05
L	1.767	44.88	2.136	54.25	2.700	68.58	.521	13.23	.250	6.35
M	1.850	46.99	2.200	55.88	2.870	72.90	.623	15.82	.290	7.37

Filter Connectors

240-791-001 Filter Receptacle with Solder Cup Pin Contacts

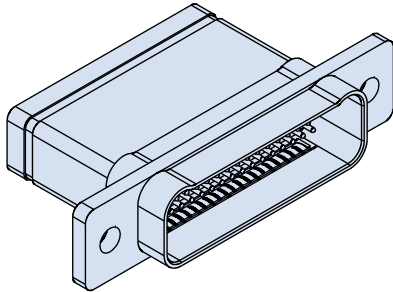

240-791-001 Filter Connector

C or Pi filters. Multi-layer planar capacitor array. Series 791 filter connectors are the next-generation higher density alternative to M24308 D Subminiature connectors. Available in 36 arrangements, 791 filter connectors feature aluminum shells, gold-plated non-removable solder cup contacts, and a shell groove for attachment of EMI shielding adapters.

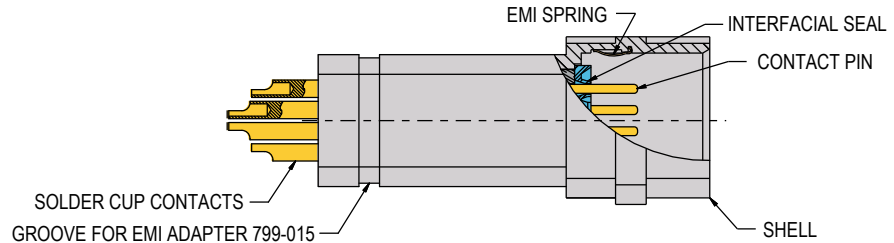

- Scoop-proof dual lobe shell
- Flight-grade shock and vibration
- C or Pi filters
- -55 to +125°C
- #23, #16, and #12 contacts in 36 arrangements

Table 3 Capacitance Class

Code	Capacitance Range (pF)	
	Pi-Section	C-Section
X*†	160,000-240,000	80,000-120,000
Y*	80,000-120,000	40,000-60,000
Z*	60,000-90,000	30,000-45,000
A	38,000-56,000	19,000-28,000
B	32,000-45,000	16,000-22,500
C	18,000-33,000	9,000-16,500
D	8,000-12,000	4,000-6,000
E	3,300-5,000	1,650-2,500
F	800-1,300	400-650
G	400-600	200-300
J	70-120	35-60

* Filter classes X, Y and Z are 250 VDC. All others are 500 VDC.

† Class X filters not available for arrangements with 3 or more rows of contacts.

Construction

- **Shell:** aluminum alloy
- **Insulators:** High grade rigid dielectric
- **Contacts:** copper alloy, 50 microinches gold over nickel plating
- **Hardware:** 300 series stainless steel, passivated

How To Order

Sample Part Number →	240-791-001P	J-33	ME	P	A	K
Product	240-791-001P Filter Plug with Pin Solder Cup Contacts					
Arrangement Number (Shell Size - Insert Arr.)	See Table 2					
Shell Finish	ME = Electroless Nickel MT = Nickel-PTFE ZR = Black Zinc-Nickel					
Filter Type	P = Pi circuit C = C circuit					
Capacitance Class	See Table 3					
Hardware Option (Table 1)	N = Thru-Hole (no hardware) S = Low Profile Screwlock, Hex Head T = Extended Screwlock, Slot Head L = Low Profile Jackscrew, Hex Head K = Extended Jackscrew, Slot Head P = Jackpost					

Specifications

- **Operating temperature:** -55 to +125°C
- **Dielectric withstanding voltage**
Filter classes A-J: 500 Vdc
Filter classes X, Y, Z: 250 Vdc
- **Insulation Resistance:** 5000 megohms minimum at 200 Vdc
- **Current rating:**
Size 23 contacts: 5A max.
Size 16 contacts: 7.5A max. for combo arrangements, 13A max. for arrangements with size 16 contacts only
Size 12 contacts: 13A max. for combo layouts, 23A max. for arrangements with size 12 contacts only
- **Shock:** EIA-364-27 condition D
- **Vibration:** EIA-364-28 condition V, letter E

Notes

1. This connector is designed to meet the requirements of MIL-STD-2120 and Glenair Series 79 Product Specification 799-008.
2. All contacts have identical filter values. Other filter styles (C-L, L-C, unbalanced Pi, multi-stage, multi-value) are available. Please consult factory for other options.

Filter Connectors

240-791-001 Filter Receptacle with Solder Cup Pin Contacts

Table 1 Hardware Option

Thread Sizes					
Hardware thread sizes vary by shell size. Shell sizes A, B, C, D, E, F, G, J, K have #4-40 UNC-2 thread, shell sizes H and L have #6-32 UNC-2 thread, shell size M has #8-32 UNC-2 thread.					
<p>N No Hardware Mounting flange has thru-holes.</p>	<p>P Jackpost Supplied loosely assembled with nut and split washer. Stainless steel.</p>	<p>L Low Profile Jackscrew Non-removable, hex head. Stainless steel.</p>	<p>K Extended Jackscrew Slot head, stainless steel, non-removable.</p>	<p>S Low Profile Screwlock Hex head, stainless steel, non-removable. Screwlocks allow the connector to be mated before the screws are fastened.</p>	<p>T Extended Screwlocks Slot head, stainless steel, non-removable. Screwlocks allow the connector to be mated before the screws are fastened.</p>

Table 2 Arrangement Number

Arrangements with Size #23 Contacts	Arrangements with Size #16 Contacts	Arrangements with Size #12 Contacts
A-5 5 #23 B-9 9 #23 C-13 13 #23 D-15 15 #23 E-19 19 #23 F-23 23 #23 G-33 33 #23 H-66 66 #23 J-33 33 #23 K-43 43 #23 L-78 78 #23 M-102 102 #23	B-2P2 2 #16 D-3P3 3 #16 D-7P2 5 #23, 2 #16 E-11P2 9 #23, 2 #16 E-7P3 4 #23, 3 #16 F-14P3 11 #23, 3 #16 F-15P2 13 #23, 2 #16 F-5P5 5 #16 H-29P7 22 #23, 7 #16 H-54P2 52 #23, 2 #16 J-17P4 13 #23, 4 #16 J-25P2 23 #23, 2 #16 J-7P7 7 #16 K-27P4 23 #23, 4 #16 K-35P2 33 #23, 2 #16 K-9P9 9 #16 M-17P17 17 #16	G-13P2 11 #23, 2 #12 G-3P3 3 #12 G-21P1 20 #23, 1 #12 H-10P4 6 #23, 4 #12 H-36P2 34 #23, 2 #12 H-5P5 5 #12 L-6P6 6 #12

Filter Connectors

240-791-001 Filter Receptacle with Solder Cup Pin Contacts

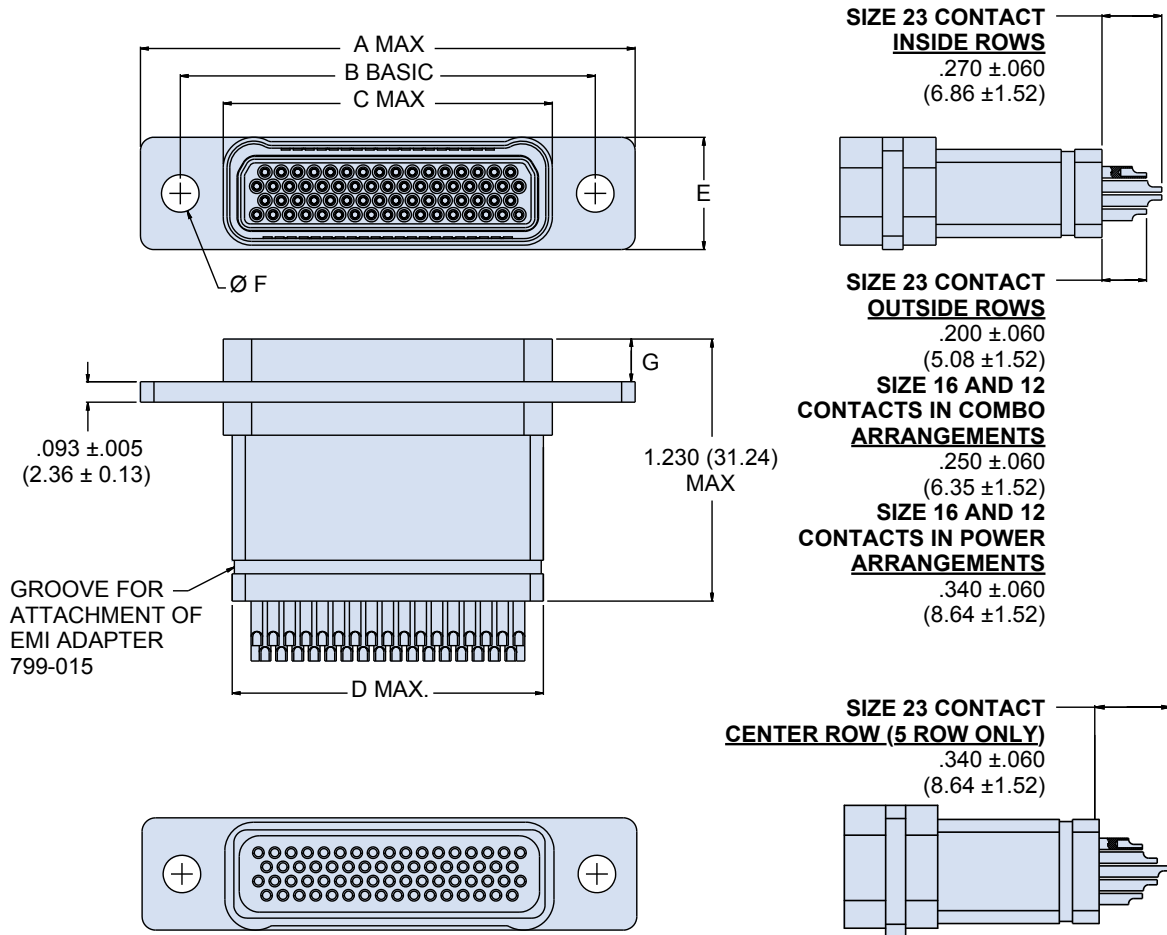

240-791-001P Dimensions

Shell Size	A Max		B Basic		C Max		D Max		E Max		F Dia ±.004 (0.10)		G ±.003 (0.08)	
	In.	mm.	In.	mm.	In.	mm.	In.	mm.	In.	mm.	In.	mm.	In.	mm.
A	1.040	26.42	.750	19.05	.490	12.45	.390	9.91	.415	10.54	.149	3.78	.195	4.95
B	1.190	30.23	.900	22.86	.640	16.26	.540	13.72	.415	10.54	.149	3.78	.195	4.95
C	1.340	34.04	1.050	26.67	.790	20.07	.690	17.53	.415	10.54	.149	3.78	.195	4.95
D	1.415	35.94	1.125	28.58	.865	21.97	.790	20.07	.415	10.54	.149	3.78	.195	4.95
E	1.565	39.75	1.275	32.39	1.015	25.78	.940	23.88	.415	10.54	.149	3.78	.195	4.95
F	1.715	43.56	1.425	36.20	1.165	29.59	1.090	27.69	.415	10.54	.149	3.78	.195	4.95
G	1.678	42.62	1.388	35.26	1.122	28.50	1.090	27.69	.500	12.70	.149	3.78	.195	4.95
H	2.275	57.79	1.900	48.26	1.516	38.51	1.440	36.58	.520	13.21	.172	4.37	.195	4.95
J	2.090	53.09	1.800	45.72	1.540	39.12	1.450	36.83	.415	10.54	.149	3.78	.195	4.95
K	2.465	62.61	2.175	55.25	1.915	48.64	1.840	46.74	.415	10.54	.149	3.78	.195	4.95
L	2.511	63.78	2.136	54.26	1.755	44.58	1.675	42.55	.520	13.21	.172	4.37	.195	4.95
M	2.580	65.53	2.200	55.88	1.815	46.10	1.740	44.20	.635	16.13	.200	5.08	.195	4.95

Filter Connectors

240-791-001 Filter Receptacle with Solder Cup Pin Contacts

Recommended Panel Cutout for Filter Rear Panel Mount Receptacles

Panel Cutout for Shell Sizes
A, B, C, D, E, F, G, J, K

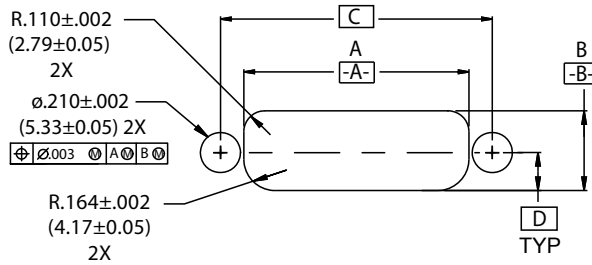

Panel Cutout for Shell Sizes
H, L

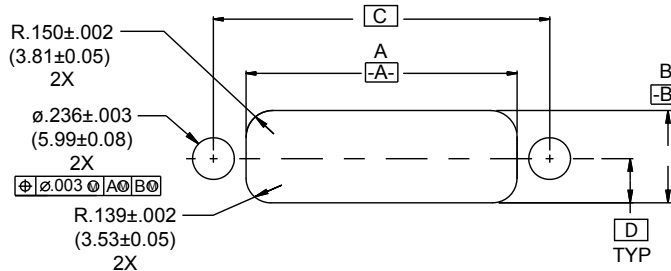

Panel Cutout for Shell Size
M

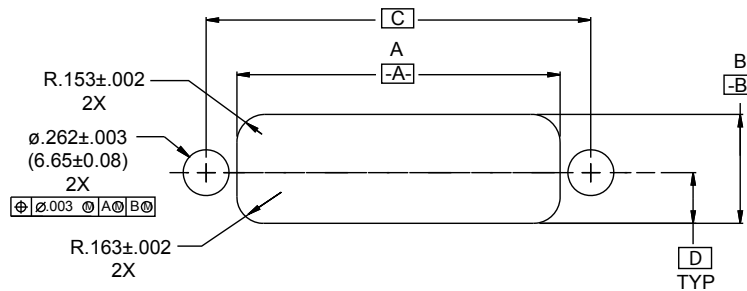

Shell Size	A ±.002(0.05)		B ±.002(0.05)		C		D	
	In.	mm.	In.	mm.	In.	mm.	In.	mm.
A	0.505	12.83	0.418	10.62	0.750	19.05	0.199	5.05
B	0.655	16.64	0.418	10.62	0.900	22.86	0.199	5.05
C	0.805	20.45	0.418	10.62	1.050	26.67	0.199	5.05
D	0.880	22.35	0.418	10.62	1.125	28.58	0.199	5.05
E	1.030	26.16	0.418	10.62	1.275	32.39	0.199	5.05
F	1.180	29.97	0.418	10.62	1.425	36.20	0.199	5.05
G	1.142	29.01	0.506	12.85	1.388	35.26	0.244	6.20
H	1.531	38.89	0.521	13.23	1.900	48.26	0.250	6.35
J	1.555	39.50	0.418	10.62	1.800	45.72	0.199	5.05
K	1.930	49.02	0.418	10.62	2.175	55.25	0.199	5.05
L	1.531	38.89	0.521	13.23	1.900	48.26	0.250	6.35
M	1.767	44.88	0.623	15.82	2.200	55.88	0.290	7.37

Filter Connectors

240-791-003 Filter Plugs with Solder Cup Socket Contacts

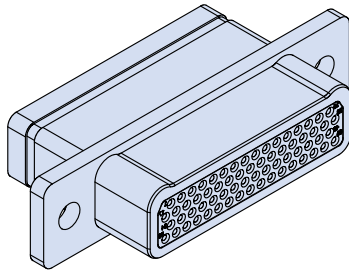

240-791-003 Filter Connector

C or Pi filters. Multi-layer planar capacitor array. Series 791 filter connectors are the next-generation higher density alternative to M24308 D Subminiature connectors. Available in 36 arrangements, 791 filter connectors feature aluminum shells, gold-plated non-removable solder cup contacts, and a shell groove for attachment of EMI shielding adapters.

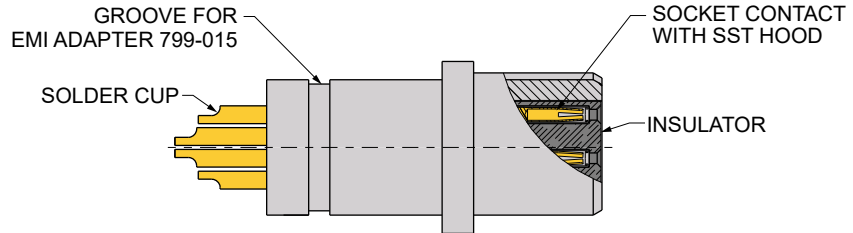

- Scoop-proof dual lobe shell
- Flight-grade shock and vibration
- C or Pi filters
- -55 to +125°C
- #23, #16, and #12 contacts in 36 arrangements

Table 3 Capacitance Class

Code	Capacitance Range (pF)	
	Pi-Section	C-Section
X*†	160,000-240,000	80,000-120,000
Y*	80,000-120,000	40,000-60,000
Z*	60,000-90,000	30,000-45,000
A	38,000-56,000	19,000-28,000
B	32,000-45,000	16,000-22,500
C	18,000-33,000	9,000-16,500
D	8,000-12,000	4,000-6,000
E	3,300-5,000	1,650-2,500
F	800-1,300	400-650
G	400-600	200-300
J	70-120	35-60

* Filter classes X, Y and Z are 250 VDC. All others are 500 VDC.

† Class X filters not available for arrangements with 3 or more rows of contacts.

Construction

- **Shell:** aluminum alloy
- **Insulators:** High grade rigid dielectric
- **Contacts:** copper alloy, 50 microinches gold over nickel plating
- **Socket contact hood:** stainless steel, passivated
- **Hardware:** 300 series stainless steel, passivated

How To Order

Sample Part Number →	240-791-003S	J-33	ME	P	A	K
Product	240-791-003S Filter Plug with Socket Solder Cup Contacts					
Arrangement Number (Shell Size - Insert Arr.)	See Table 2					
Shell Finish	ME = Electroless Nickel MT = Nickel-PTFE ZR = Black Zinc-Nickel					
Filter Type	P = Pi circuit C = C circuit					
Capacitance Class	See Table 3					
Hardware Option (Table 1)	N = Thru-Hole (no hardware) S = Low Profile Screwlock, Hex Head T = Extended Screwlock, Slot Head L = Low Profile Jackscrew, Hex Head K = Extended Jackscrew, Slot Head P = Jackpost					

Specifications

- **Operating temperature:** -55 to +125°C
- **Dielectric withstanding voltage**
Filter classes A-J: 500 Vdc
Filter classes X, Y, Z: 250 Vdc
- **Insulation Resistance:** 5000 megohms minimum at 200 Vdc
- **Current rating:**
Size 23 contacts: 5A max.
Size 16 contacts: 7.5A max. for combo arrangements, 13A max. for arrangements with size 16 contacts only
Size 12 contacts: 13A max. for combo layouts, 23A max. for arrangements with size 12 contacts only
- **Shock:** EIA-364-27 condition D
- **Vibration:** EIA-364-28 condition V, letter E

Notes

1. This connector is designed to meet the requirements of MIL-STD-2120 and Glenair Series 79 Product Specification 799-008.
2. All contacts have identical filter values. Other filter styles (C-L, L-C, unbalanced Pi, multi-stage, multi-value) are available. Please consult factory for other options.

Filter Connectors

240-791-003 Filter Plugs with Solder Cup Socket Contacts

Table 1 Hardware Option

Thread Sizes					
Hardware thread sizes vary by shell size. Shell sizes A, B, C, D, E, F, G, J, K have #4-40 UNC-2 thread, shell sizes H and L have #6-32 UNC-2 thread, shell size M has #8-32 UNC-2 thread.					
 N No Hardware Mounting flange has thru-holes.	 P Jackpost Supplied loosely assembled with nut and split washer. Stainless steel.	 L Low Profile Jackscrew Non-removable, hex head. Stainless steel.	 K Extended Jackscrew Slot head, stainless steel, non-removable.	 S Low Profile Screwlock Hex head, stainless steel, non-removable. Screwlocks allow the connector to be mated before the screws are fastened.	 T Extended Screwlocks Slot head, stainless steel, non-removable. Screwlocks allow the connector to be mated before the screws are fastened.

Table 2 Arrangement Number

Arrangements with Size #23 Contacts	Arrangements with Size #16 Contacts	Arrangements with Size #12 Contacts
 A-5 5 #23	 B-2P2 2 #16	 G-13P2 11 #23, 2 #12
 B-9 9 #23	 D-3P3 3 #16	 G-3P3 3 #12
 C-13 13 #23	 D-7P2 5 #23, 2 #16	 G-21P1 20 #23, 1 #12
 D-15 15 #23	 E-11P2 9 #23, 2 #16	 H-10P4 6 #23, 4 #12
 E-19 19 #23	 E-7P3 4 #23, 3 #16	 H-36P2 34 #23, 2 #12
 F-23 23 #23	 F-15P2 13 #23, 2 #16	 H-5P5 5 #12
 G-33 33 #23	 F-5P5 5 #16	 H-5P5 5 #12
 H-66 66 #23	 H-29P7 22 #23, 7 #16	 L-6P6 6 #12
 J-33 33 #23	 H-54P2 52 #23, 2 #16	 M-17P17 17 #16
 K-43 43 #23	 J-17P4 13 #23, 4 #16	
 L-78 78 #23	 J-7P7 7 #16	
 M-102 102 #23	 K-27P4 23 #23, 4 #16	
	 K-35P2 33 #23, 2 #16	
	 K-9P9 9 #16	

Filter Connectors

240-791-003 Filter Plugs with Solder Cup Socket Contacts

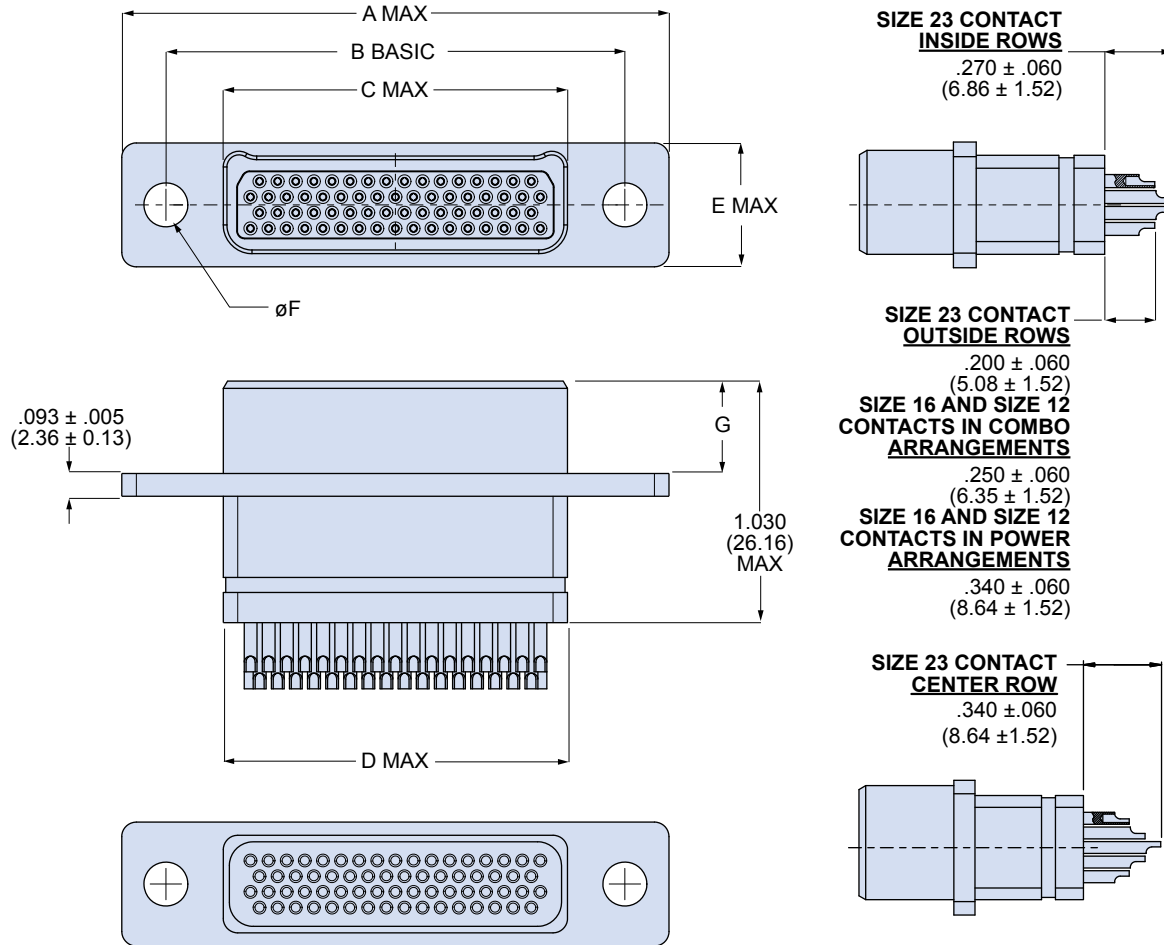

240-791-003S Dimensions

Shell Size	A Max		B Basic		C Max		D Max		E Max		F Dia ±.004 (0.10)		G ±.003 (0.08)	
	In.	mm.	In.	mm.	In.	mm.	In.	mm.	In.	mm.	In.	mm.	In.	mm.
A	1.040	26.42	.750	19.05	.410	10.41	.390	9.91	.415	10.54	.149	3.78	.383	9.73
B	1.190	30.23	.900	22.86	.560	14.22	.540	13.72	.415	10.54	.149	3.78	.383	9.73
C	1.340	34.04	1.050	26.67	.710	18.03	.690	17.53	.415	10.54	.149	3.78	.383	9.73
D	1.415	35.94	1.125	28.58	.785	19.94	.790	20.07	.415	10.54	.149	3.78	.383	9.73
E	1.565	39.75	1.275	32.39	.935	23.75	.940	23.88	.415	10.54	.149	3.78	.383	9.73
F	1.715	43.56	1.425	36.20	1.085	27.56	1.090	27.69	.415	10.54	.149	3.78	.383	9.73
G	1.673	40.84	1.388	35.25	1.047	26.59	1.090	27.69	.500	12.70	.149	3.78	.383	9.73
H	2.275	57.79	1.900	48.26	1.437	36.50	1.440	36.58	.520	13.21	.172	4.37	.383	9.73
J	2.090	53.09	1.800	45.72	1.460	37.08	1.450	36.83	.415	10.54	.149	3.78	.383	9.73
K	2.465	62.61	2.175	55.25	1.835	46.61	1.840	46.74	.415	10.54	.149	3.78	.383	9.73
L	2.511	63.78	2.136	54.26	1.673	42.49	1.675	42.55	.520	13.21	.172	4.37	.383	9.73
M	2.580	65.53	2.200	55.88	1.734	44.04	1.740	44.20	.635	16.13	.200	5.08	.423	10.74

Filter Connectors

240-791-003 Filter Plugs with Solder Cup Socket Contacts

Recommended Panel Cutout for Filter Rear Panel Mount Plug

Panel Cutout for Shell Sizes
A, B, C, D, E, F, G, J, K

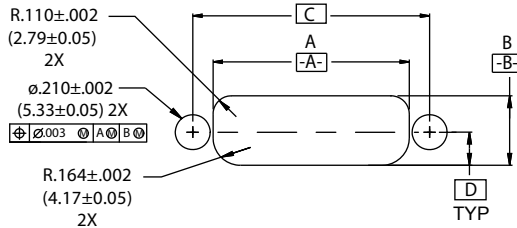

Panel Cutout for Shell Sizes
H, L

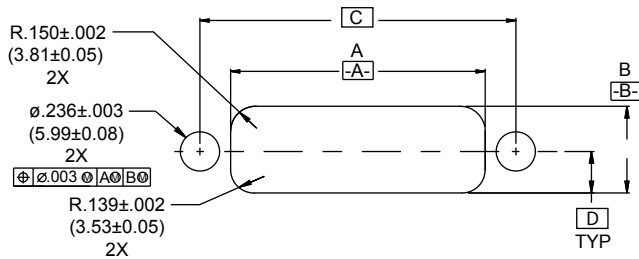

Panel Cutout for Shell Size
M

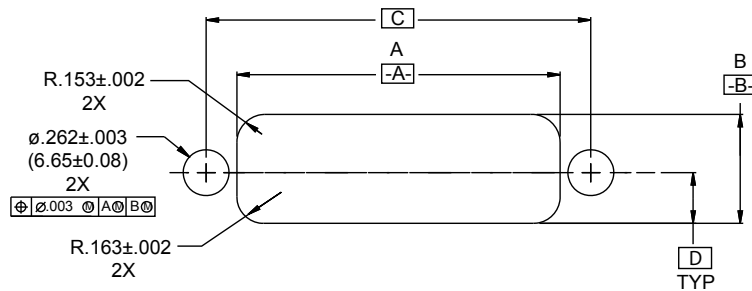

Shell Size	A ±.002(0.05)		B ±.002(0.05)		C Basic		D Basic	
	In.	mm.	In.	mm.	In.	mm.	In.	mm.
A	0.505	12.83	0.418	10.62	0.750	19.05	0.199	5.05
B	0.655	16.64	0.418	10.62	0.900	22.86	0.199	5.05
C	0.805	20.45	0.418	10.62	1.050	26.67	0.199	5.05
D	0.880	22.35	0.418	10.62	1.125	28.58	0.199	5.05
E	1.030	26.16	0.418	10.62	1.275	32.39	0.199	5.05
F	1.180	29.97	0.418	10.62	1.425	36.20	0.199	5.05
G	1.142	29.01	0.506	12.85	1.388	35.26	0.244	6.20
H	1.531	38.89	0.521	13.23	1.900	48.26	0.250	6.35
J	1.555	39.50	0.418	10.62	1.800	45.72	0.199	5.05
K	1.930	49.02	0.418	10.62	2.175	55.25	0.199	5.05
L	1.531	38.89	0.521	13.23	1.900	48.26	0.250	6.35
M	1.767	44.88	0.623	15.82	2.200	55.88	0.290	7.37

Pin and Socket Contacts for Series 79 Connectors

Crimp Contacts

Size 23 Crimp Contacts

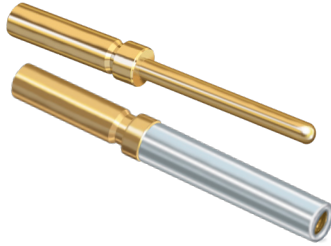

Size 23 contacts are designed to meet SAE AS39029 requirements. These snap-in, rear release contacts are compatible with Series 790 and 791 connectors.

Technical Data	
Specifications	
■ Operating temperature: -65 to +150°C	
■ Current rating: 5A	
■ Crimp Tensile Strength	
Wire Size	Axial Load (lbs.)
22	12
24	8
26	5
28	3
30	1.5
■ Voltage Drop: 73 millivolts maximum, 5A, 25° C, 22 AWG wire	
Construction	
■ Contact body: copper alloy	
■ Socket hood: stainless steel, passivated	
■ Contact finish: 50 microinches minimum gold plating over nickel underplate	

Size #23 Crimp Contacts								
Contact Type	AWG Wire Size	Part Number	Ø A		Color Band	Crimp Tools		Insertion/Removal Tool
			In.	mm.		Crimper	Positioner	
Pin	22-28	809-001	.0335/ .0355	0.851/ 0.902	None	809-015 (M22520/2-01)	809-005 (K1461)	809-088
Pin	26-30	809-042	.0229/ .0245	0.582/ 0.632	Blue	809-015 (M22520/2-01)	809-057	809-088
Socket	22-28	809-002	.0335/ .0355	0.851/ 0.902	None	809-015 (M22520/2-01)	809-005 (K1461)	809-088
Socket	26-30	809-043	.0229/ .0245	0.582/ 0.632	Blue	809-015 (M22520/2-01)	809-057	809-088

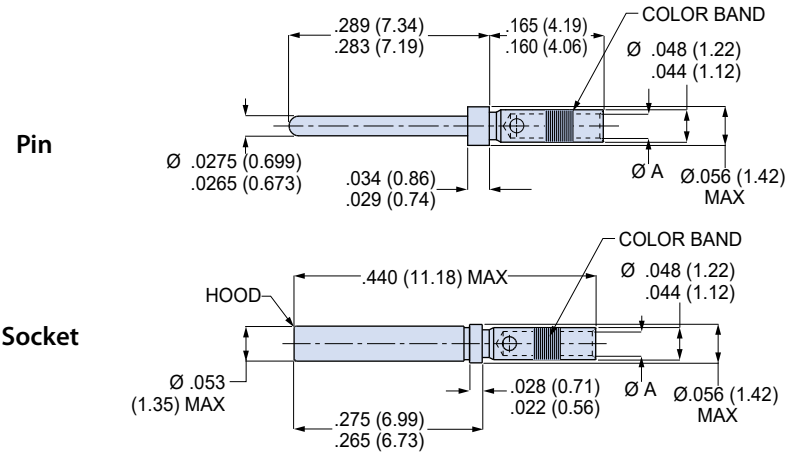

Size 16 Power Contacts

Standard size #16 contacts accept #16 to #20 AWG wire. Approved to SAE-AMS-39029.

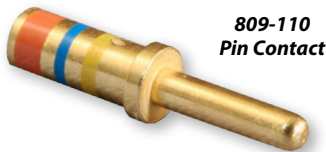

Size #16 Power Contacts					
Contact Type	AWG Wire Size	Part Number	Crimp Tools		Insertion/Removal Tool
			Crimper	Positioner	
Pin	16-20	809-110 (M39029/58-364)	809-136 (M22520/1-01)	809-137 (M22520/1-04)	809-131 (M81969/14-03)
Socket	16-20	809-111 (M39029/57-358)	809-136 (M22520/1-01)	809-137 (M22520/1-04)	809-131 (M81969/14-03)

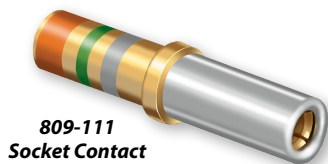
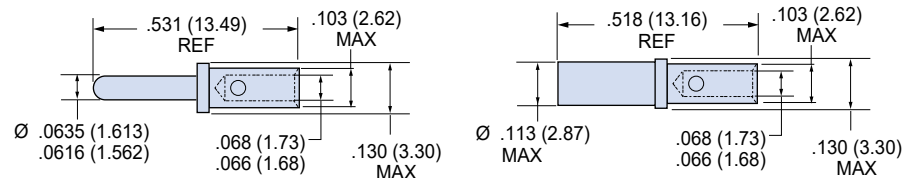

Technical Data	
Specifications	Construction
<ul style="list-style-type: none"> ■ Operating temperature: -65 to +200°C ■ Current rating: 13 ampere ■ Voltage Drop: 49 millivolts maximum@13A, 16 AWG wire 	<ul style="list-style-type: none"> ■ Contact body: copper alloy, 50 microinches gold over nickel plating ■ Socket hood: stainless steel, passivated

Pin and Socket Contacts for Series 79 Connectors

Crimp Contacts

Size 12 Power Contacts

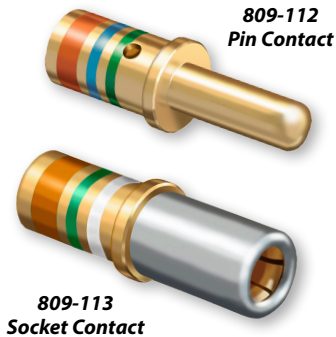

Standard size #12 contacts accept #12 to #14 AWG wire. Approved to SAE-AMS-39029.

Size #12 Power Contacts					
Contact Type	AWG Wire Size	Part Number	Crimp Tools		Insertion/Removal Tool
			Crimper	Positioner	
Pin	12-14	809-112 (M39029/58-365)	809-136 (M22520/1-01)	809-137 (M22520/1-04)	809-132 (M81969/14-04)
Socket	12-14	809-113 (M39029/57-359)	809-136 (M22520/1-01)	809-137 (M22520/1-04)	809-132 (M81969/14-04)

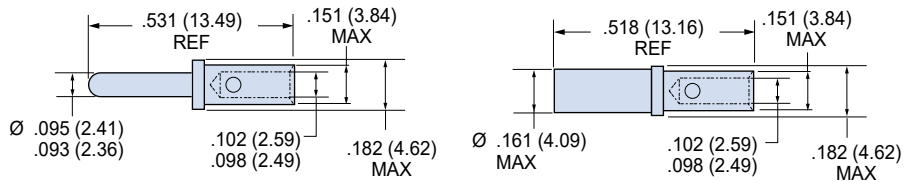

Technical Data	
Specifications	Construction
<ul style="list-style-type: none"> Operating temperature: -65 to +200°C Current rating: 23 ampere Voltage Drop: 42 millivolts maximum@20A 	<ul style="list-style-type: none"> Contact body: copper alloy, 50 microinches gold over nickel plating Socket hood: stainless steel, passivated

Size 8 Power Contacts



Size 8 contacts are designed to meet SAE AS39029 requirements. Snap in, rear release. Supplied with 859-042-03 sealing boot.

Size #8 Power Contacts						
Contact Type	AWG Wire Size	Part Number	Crimp Tools			Removal Tool
			Pneumatic Crimper	Die Assembly	Positioner	
Pin	8	850-014F	859-025 (M22520/23-01)	859-026 (M22520/23-02)	859-046 (WA23-395L)	859-049 (M81969/14-12)
Socket	8	850-138F	859-025 (M22520/23-01)	859-026 (M22520/23-02)	859-046 (WA23-395L)	859-049 (M81969/14-12)

Technical Data	
Specifications	Construction
<ul style="list-style-type: none"> Operating temperature: -65 to +200°C Current rating: 46 ampere Voltage Drop: 26 millivolts maximum@46A 	<ul style="list-style-type: none"> Contact body: copper alloy, 50 microinches gold over nickel plating Socket hood: stainless steel, passivated

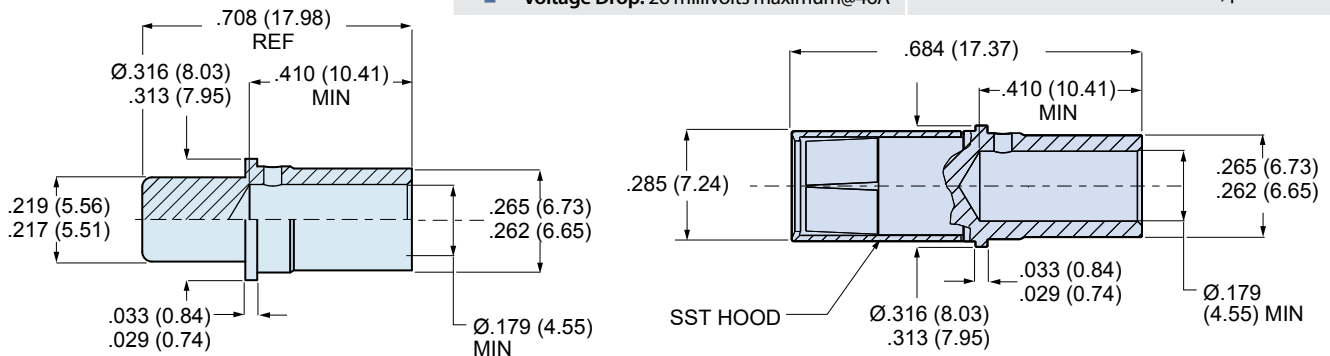

Coaxial Contacts for Series 79 Connectors

Size #12 AS39029 Coaxial Contacts

These snap-in, rear-release contacts Series 79 connectors with size #12 cavities. Crimp termination. SAE AS39029 qualified.



Technical Data	
Specifications	Construction
<ul style="list-style-type: none"> Operating temperature: -65 to +200°C Dielectric withstanding voltage: 1000 Vac rms at sea level, 250 Vac at 50,000 feet Current rating: 1 ampere Durability: 500 mating cycles 	<ul style="list-style-type: none"> Inner contact, body, outer sleeve: copper alloy, gold over nickel underplate per AS39029 Type D Socket contact hood: stainless steel Insulator: fluoroplastic

Size #12 AS39029 Coaxial Contacts

RG Cable	Size	Freq.	Pin Contact	Socket Contact	Crimp Tools				Insertion/Removal Tool
					Inner Contact Crimper	Positioner	Shield Crimp Sleeve Crimper	Die Set	
RG174	12	700 MHz	852-002-12-211 (M39029/28-211)	852-001-12-210 (M39029/27-210)	809-015 (M22520/2-01)	809-135 (M22520/2-34)	809-133 (M22520/31-01)	809-134 (M22520/31-02)	809-132 (M81969/14-04)
RG179	12	200 MHz	852-002-12-211 (M39029/28-211)	852-001-12-210 (M39029/27-210)	809-015 (M22520/2-01)	809-135 (M22520/2-34)	809-133 (M22520/31-01)	809-134 (M22520/31-02)	809-132 (M81969/14-04)
RG180	12	700 MHz	852-002-12-409 (M39029/28-409)	852-001-12-402 (M39029/27-402)	809-015 (M22520/2-01)	809-135 (M22520/2-34)	809-133 (M22520/31-01)	809-134 (M22520/31-02)	809-132 (M81969/14-04)
RG316	12	700 MHz	852-002-12-211 (M39029/28-211)	852-001-12-210 (M39029/27-210)	809-015 (M22520/2-01)	809-135 (M22520/2-34)	809-133 (M22520/31-01)	809-134 (M22520/31-02)	809-132 (M81969/14-04)

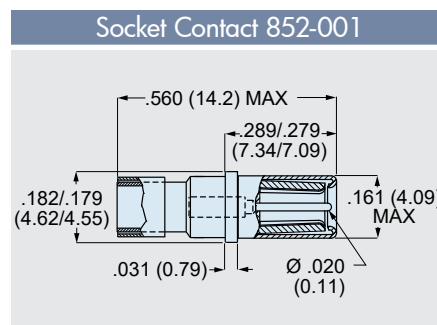
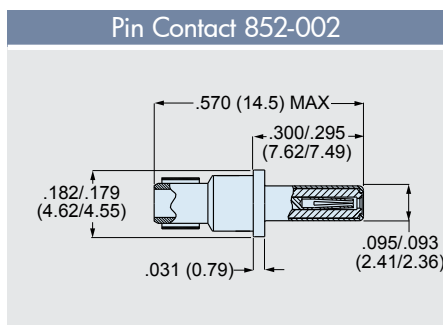

AS39029 Color Stripes

AS39029 Part No.	Color Bands		
	1st	2nd	3rd
M39029/27-210	RED	BROWN	BLACK
M39029/27-402	YELLOW	BLACK	RED
M39029/28-211	RED	BROWN	BROWN
M39029/28-409	YELLOW	BLACK	WHITE
M39029/102-558	GREEN	GREEN	GRAY

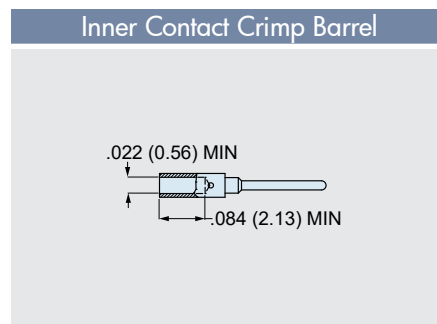
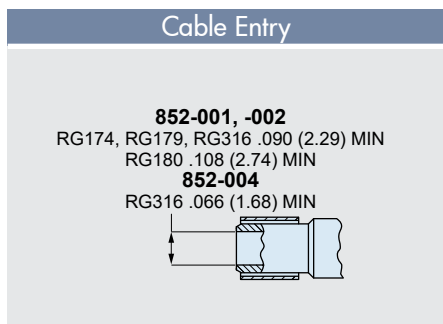

Coaxial Contacts for Series 79 Connectors

Size #16 AS39029 Coaxial Contacts

These snap-in, rear-release contacts fit Series 79 connectors with size #16 cavities. Crimp termination. SAE AS39029 qualified.



Technical Data	
Specifications	Construction
<ul style="list-style-type: none"> Operating temperature: -65 to +200°C Dielectric withstanding voltage: 800 Vac rms at sea level, 250 Vac at 50,000 feet Current rating: 1 ampere Durability: 500 mating cycles VSWR: 1.50 max. @ 500 MHz 	<ul style="list-style-type: none"> Inner contact, body, outer sleeve: copper alloy, gold over nickel underplate per AS39029 Type D Socket contact hood: stainless steel Insulator: fluoroplastic

Size #16 AS39029 Coaxial Contacts

RG Cable	Size	Max. Freq.	Pin Contact	Socket Contact	Crimp Tools				Insertion/Removal Tool
					Inner Contact Crimper	Inner Contact Positioner	Shield Crimp Sleeve Crimper	Shield Crimp Sleeve Die Set	
RG174 RG179 RG316	16	500 MHz	852-008-16-424 (M39029/76-424)	852-010-16-432 (M39029/78-432)	809-015 (M22520/2-01)	809-125 (M22520/2-35)	809-127 (M22520/4-01)	809-126 (M22520/4-02)	809-131 (M81969/14-03)
RG178	16	500 MHz	852-008-16-425 (M39029/76-425)	852-010-16-433 (M39029/78-433)					

Pin Contact 852-008

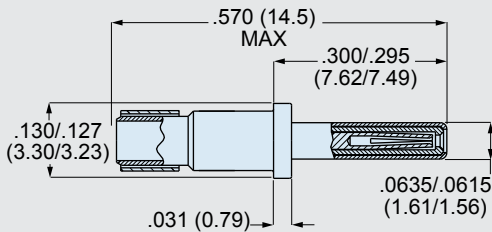

Socket Contact 852-010

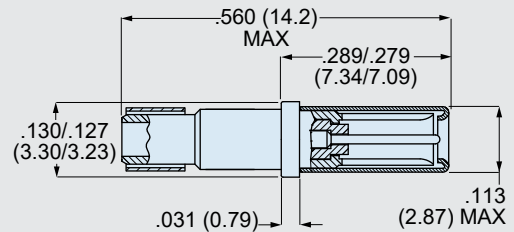

AS39029 Color Stripes

AS39029 Part No.	Color Bands		
	1st	2nd	3rd
M39029/76-424	YEL	RED	YEL
M39029/76-425	YEL	RED	GRN
M39029/78-432	YEL	ORN	RED
M39029/78-433	YEL	ORN	ORN

Cable Entry

RG174, RG179, RG316
.067 (1.70) MIN
RG178
.0575 (1.46) MIN

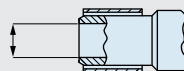

Inner Contact Crimp Barrel

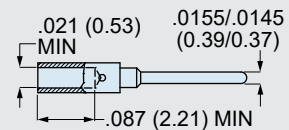

Coaxial Contacts for Series 79 Connectors

Size #12 50 Ohm High Frequency Matched-Impedance Coaxial Contacts

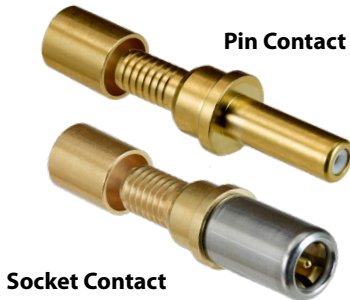

High Frequency coax contacts fit Glenair Series 79 connectors with size 12 contact cavities. 50 ohm nominal impedance. DC – 3 GHz frequency range. Contacts are snap-in, rear-release.

Size 12 50 Ohm High Frequency Matched-Impedance Coaxial Contacts			
RG Cable	Max. Freq.	Pin Contact	Socket Contact
RG178 (M17/93-RG178)	3 GHz	852-016-03	852-015-03
RG316 (M17/113-RG316)	3 GHz	852-016-01	852-015-01
RG316DS (M17/152-00001)	3 GHz	852-016-02	852-015-02
RG405-FLEX	3 GHz	852-018	852-017

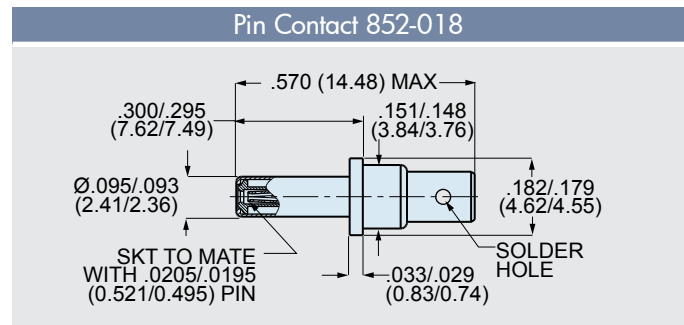
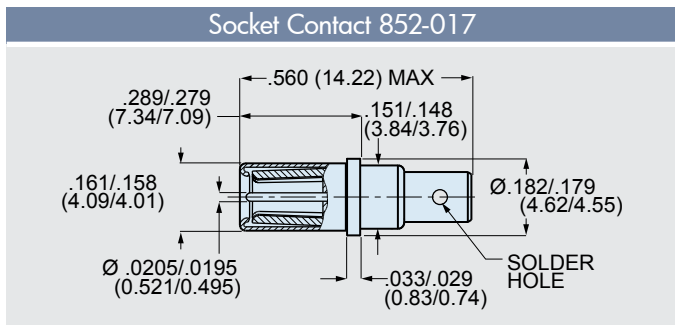
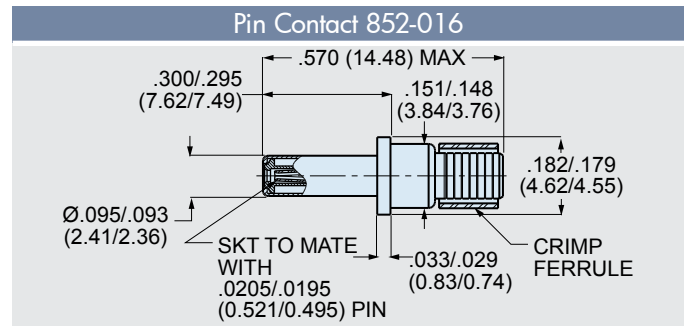
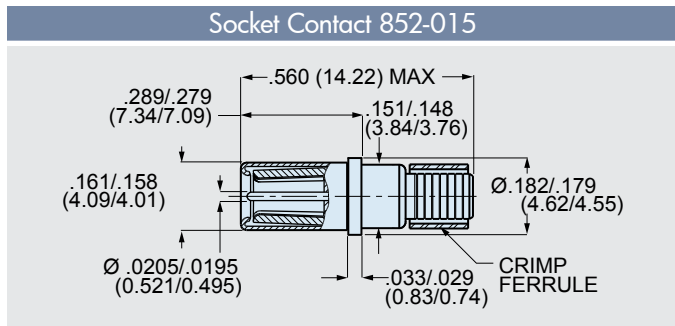

Technical Data	
Specifications	
■	Operating temperature: -65°C to +200°C
■	VSWR: 1.32:1 max. @ 3 GHz
■	Nominal impedance: 50 ohms
■	Insertion loss: 0.20 dB maximum at 3 GHz
■	Dielectric withstanding voltage: 1000 Vac rms at sea level
■	Current rating: 1 ampere
■	Durability: 500 mating cycles
■	Shock: EIA-364-27 condition D
■	Vibration: EIA-364-28 condition VI, letter J
Construction	
■	Center contact, body, crimp sleeve: copper alloy, 50 microinches gold over nickel plating
■	Insulator: fluoroplastic

Crimp Tools, Installation/Removal Tool					
Contact Part Number	Crimp Tools				Installation/Removal Tool
	Inner Crimper	Positioner	Shield Crimper	Hex Die	
852-015	809-128 (MH992)	859-006 (K1721)	809-129 (M22520/5-01)	809-130 (M22520/5-03)	809-132 (M81969/14-04)
852-016	809-128 (MH992)	859-006 (K1721)	809-129 (M22520/5-01)	809-130 (M22520/5-03)	809-132 (M81969/14-04)
852-017	(Solder termination)	(Solder termination)	(Solder termination)	(Solder termination)	809-132 (M81969/14-04)
852-018	(Solder termination)	(Solder termination)	(Solder termination)	(Solder termination)	809-132 (M81969/14-04)



Coaxial Contacts for Series 79 Connectors

Size #12 75 Ohm High Frequency Matched-Impedance Coaxial Contacts

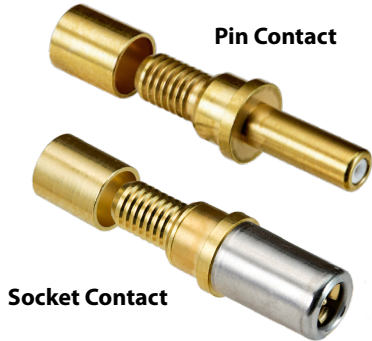

75 ohm coax contacts provide DC – 3 GHz frequency range. Crimp termination. Supplied as unassembled kit with contact body, center contact and outer ferrule. These snap-in, rear-release contacts fit Glenair Series 79 connectors. Gold-plated copper alloy, fluoroplastic insulator.

Size 12 75 Ohm High Frequency Matched-Impedance Coaxial Contacts		
RG Cable	Pin Contact	Socket Contact
RG179 (M17/94-RG179)	852-103-02	852-104-02
V75268, V76261, V73263 (PIC™ Wire and Cable)	852-103-01	852-104-01

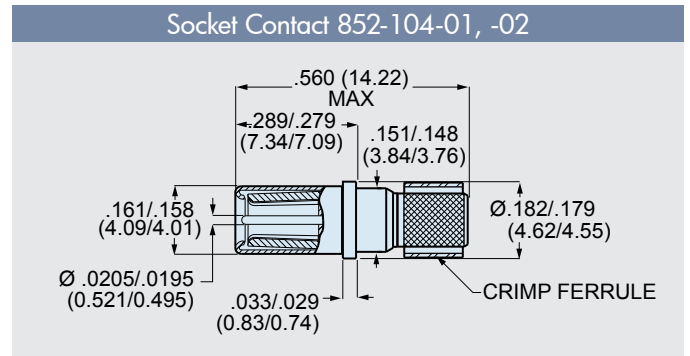
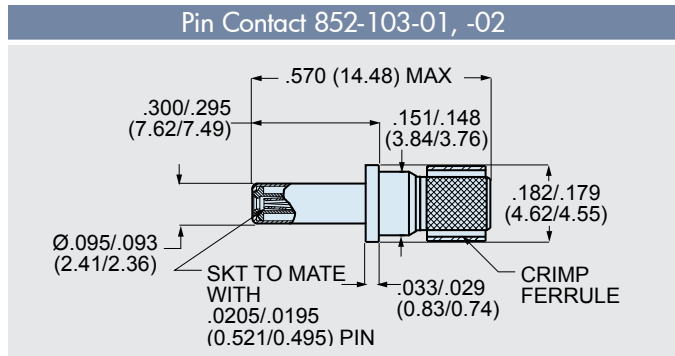

Technical Data	
Specifications	
■	Operating temperature: -65 to +200°C
■	Dielectric withstanding voltage: 500 Vac
■	Current rating: 1 ampere
■	VSWR: 1.25:1 max. @ 3 GHz
■	Impedance: 75 ohm
■	Durability: 500 mating cycles
■	Shock: EIA-364-27 condition D
■	Vibration: EIA-364-28 condition VI, letter J
Construction	
■	Center contact, body, crimp sleeve: copper alloy, 50 microinches gold over nickel plating
■	Insulator: fluoroplastic
■	Hood: stainless steel, passivated

Crimp Tools, Installation/Removal Tool					
Contact Part Number	Crimp Tools				Insertion/Removal Tool
	Inner Contact		Shield Crimp Sleeve		
	Crimper	Positioner	Crimper	Positioner	
852-103-01	809-128 (MH992)	859-006 (K1721)	809-133 (M22520/31-01)	859-128 (GP959)	809-132 (M81969/14-04)
852-103-02	809-128 (MH992)	859-006 (K1721)	809-129 (M22520/5-01)	809-130 (M22520/5-03)	809-132 (M81969/14-04)
852-104-01	809-128 (MH992)	859-006 (K1721)	809-133 (M22520/31-01)	859-128 (GP959)	809-132 (M81969/14-04)
852-104-02	809-128 (MH992)	859-006 (K1721)	809-129 (M22520/5-01)	809-130 (M22520/5-03)	809-132 (M81969/14-04)

Inner Contact Crimp Tools

809-128 (MH992) **859-006** (K1721)

Installation/Removal Tool

809-132
(M81969/14-04)

Shield Crimp Tools

809-133 (M22520/31-01) **859-128** (GP959)

809-129 (M22520/5-01) **809-130** (M22520/5-03)

Coaxial Contacts for Series 79 Connectors

Size #12 SMPM-Type Spring-Loaded Contacts for DC – 40 GHz



Male Contact

Female Contact

50 ohm high frequency size #12 coaxial contacts fit Glenair Series 79 connectors. Maximum operating frequency 40 GHz. Spring-loaded male contact assures consistent mating dimensions and superior performance. Supplied fully assembled with cable termination instruction sheet.

- DC – 40 GHz frequency range
- 50 ohm impedance
- Aerospace-grade construction
- SMPM-type Interface per MIL-DTL-348
- Spring-loaded interface
- Low insertion loss
- Solderless center contact
- VSWR 1.3 at 40 GHz

Size 12 50 Ohm SMPM-Type Coaxial Contacts for DC – 40 GHz

Cable	Female Contact (Use in Pin Connectors)	Male Contact (Use in Socket Connectors)
RG-405 Flex (Times Microwave TFlex-405) Tensolite LLF-1087)	852-025-01	852-032-01

Technical Data

Specifications

- Operating temperature: -55°C to +125°C
- Dielectric withstanding voltage: 500 Vac
- Ins. resistance: 5000 megohms min.
- Frequency range: DC – 40 GHz
- VSWR: 1.10 + (.005 x Freq GHz)
- Impedance: 50 ohm
- Insertion loss: .04 x $\sqrt{(\text{Freq in GHz})}$
- RF leakage: -(90 – Freq GHz)
- Durability: 500 mating cycles

Construction

- Center contact: copper alloy, 50 microinches gold over nickel plating
- Dielectric: PTFE per ASTM D-1710
- Female body: copper alloy, 50 microinches gold over nickel plating
- Male body: stainless steel, passivated
- Male contact spring: high carbon steel (music wire), nickel plated

Male Contact 852-032-01

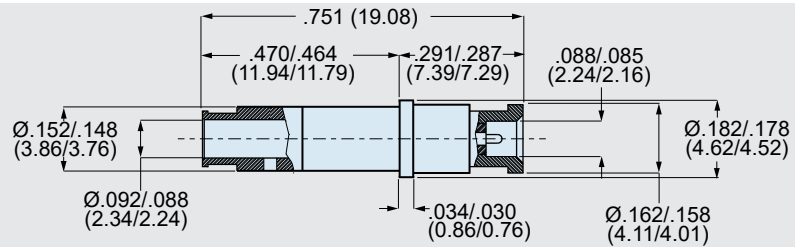

Female Contact 852-025-01

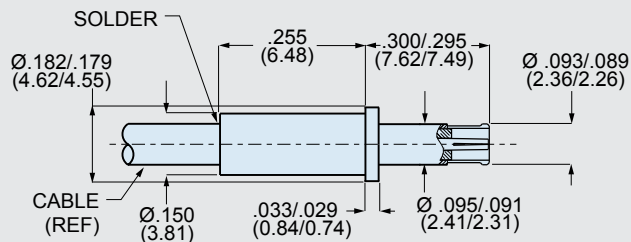

Cable Prep Dimensions for 852-025

Slide prepped cable into contact, then solder cable braid to contact body. See Assembly Instruction Sheet AI85009 for complete termination instructions.

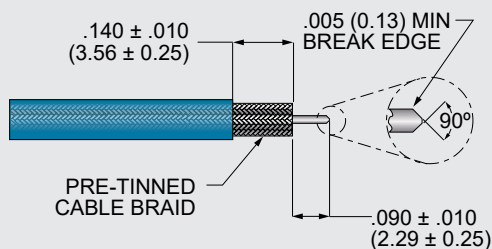

Cable Prep Dimensions for 852-032

Slide prepped cable into contact, then solder cable braid to contact body. See Assembly Instruction Sheet AI85010 for complete termination instructions.

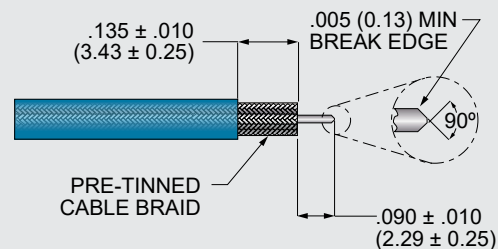

Pneumatic Contacts for Series 790 and 791 Connectors

Size #12 Pneumatic Contacts



Stainless steel pneumatic contacts attach to 3/32 inch (2.38) diameter tubing. Compatible with all Series 79 and Series 80 Mighty Mouse connectors. Socket contact has o-ring and PTFE backup washers. Contacts snap into size #12 connector cavities. Originally designed for pitot tube connections, these pneumatic contacts are rated for 100 PSI maximum air pressure. No installation tool is required. Remove contacts with plastic extraction tool 809-132.

- 100 psi
- Stainless steel
- Accepts 3/32 in. diameter tube
- Fits in standard #12 contact cavity

Size #12 Pneumatic Contacts			
Contact Type	Tube I.D.	Pin Contact	Socket Contact
Pneumatic	.094 (2.38)	857-011	857-010

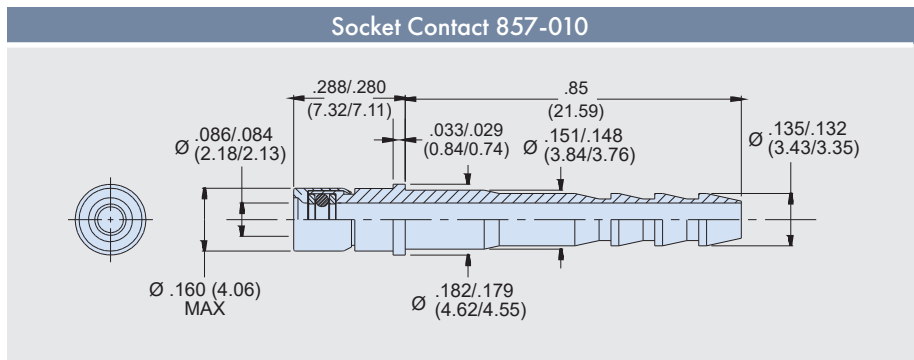
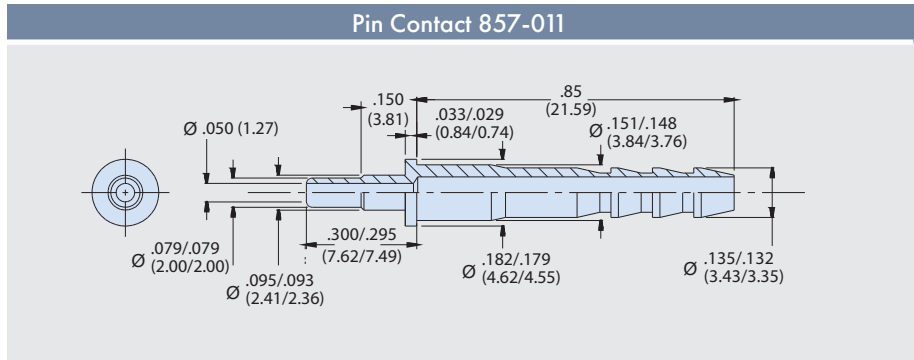
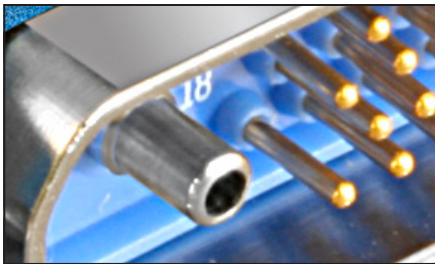

Technical Data

Specifications

- Operating temperature: -65 to +200°C
- Maximum static air pressure 100 psi (6.8 bar)

Construction

- Body: stainless steel, passivated
- O-ring: fluorosilicone
- Washers: PTFE

Backshells for Series 791 Connectors

799-015 EMI Banding Backshell for 791-001 and 791-003 Connectors



Low profile. Two piece. EMI protection. Band-Master shield termination.

Attach cable braid to connector with 799-015 adapters. These adapters fit securely into a groove on 791-001 and 791-003 cable connectors. Elliptical cable entry provides room for large wire bundles. Machined T6061 aluminum adapters consist of two interlocking housings, two fillister head screws and two lockwashers. These lightweight, space-saving adapters are available in straight or right angle configurations with a range of cable entry sizes.

Technical Data	
Specifications	
■	Use with Glenair Band-Master™ ATS Micro Termination Tool and Microband shield termination strap
Construction	
■	Shell: aluminum alloy
■	Hardware: stainless steel, passivated

Table 1 Cable Entry Code			
Cable Entry Code	D		Shell Size
	In.	mm.	
01	.140	3.56	A-M
02	.290	7.37	B-M
03	.440	11.18	C-M
04	.540	13.72	D-M
05	.690	17.53	E-M
06	.810	20.57	F-M
07	1.000	25.40	H-M
08	1.190	30.23	H-M
09	1.305	33.15	K-M
10	1.420	36.07	K-M
11	1.600	40.64	K
12	1.500	38.10	K and M

How To Order							
Sample Part Number	799-015	T	M	E	01	M	01
Product	799-015 Low profile banding backshell						
Cable Entry Style	T = Top entry S = Side entry						
Shell Finish	M = Electroless Nickel MT = Nickel-PTFE ZR = Black Zinc-Nickel						
Shell Size	A B C D E F G H J K L M						
Cable Entry Code	See Table 1						
Band Strap Option	N = No Band (order band separately) M = Band included. Band-Master MicroBand, .125 (3.18) wide						
Height Code	See table 2						

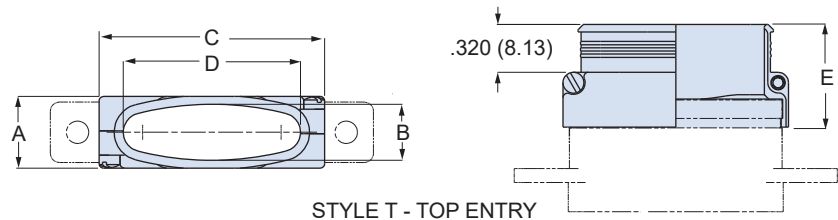
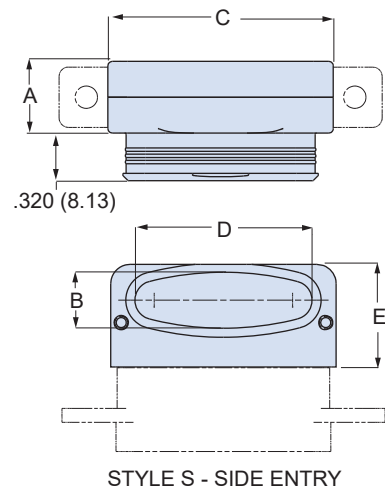

Table 2 Height Code		
Height Code	E	
	In.	mm.
01	.810	20.6
02	.940	23.9
03	1.060	26.9
04	1.190	30.2
05	1.310	33.3
06	1.440	36.6
07	1.560	39.6
08	1.690	42.9
09	1.810	46.0
10	1.940	49.3
11	1.600	40.6
12	1.500	38.1

Dimensions									
Shell Size	A Max		B Max		C Max		Available Entry Sizes		
	In.	mm.	In.	mm.	In.	mm.			
A	.385	9.78	.270	6.86	.485	12.32	01		
B	.385	9.78	.270	6.86	.635	16.13	01 thru 02		
C	.385	9.78	.270	6.86	.785	19.94	01 thru 03		
D	.385	9.78	.270	6.86	.885	22.48	01 thru 04		
E	.385	9.78	.270	6.86	1.035	26.29	01 thru 05		
F	.385	9.78	.270	6.86	1.185	30.10	01 thru 06		
G	.465	11.81	.350	8.89	1.145	29.08	01 thru 06		
H	.495	12.57	.380	9.65	1.525	38.74	01 thru 08		
J	.385	9.78	.270	6.86	1.545	39.24	01 thru 08		
K	.385	9.78	.270	6.86	1.945	49.40	01 thru 11		
L	.495	12.57	.380	9.65	1.765	44.83	01 thru 10		
M	.555	14.10	.440	11.18	1.830	46.48	01 - 10, 12		



Backshells for Series 791 Connectors

799-016 EMI Banding Adapter for 791-019 and 791-020 Panel Mount Connectors



799-016

Technical Data	
Specifications	
<ul style="list-style-type: none"> Use with Glenair Band-Master™ ATS Micro Termination Tool and Microband shield termination strap 	
Construction	
<ul style="list-style-type: none"> Shell: aluminum alloy Hardware: stainless steel, passivated 	

EMI protection. Band-Master shield termination.

Attach cable braid to panel mounted connectors with 799-016 adapters. These adapters attach to threaded holes on 791-019 and 791-020 connectors. Elliptical cable entry provides room for large wire bundles. Machined T6061 aluminum adapter consists of one piece shell, two fillister head screws and two lockwashers. These lightweight, space-saving adapters are available in straight, 45° and side entry configurations and a range of cable entry sizes.

How To Order							
Sample Part Number	799-016	T	M	H	08	M	12
Product	799-016 Banding adapter						
Cable Entry Style	T = Top entry S = Side entry 90° E = 45°						
Shell Finish	M = Electroless Nickel MT = Nickel-PTFE ZR = Black Zinc-Nickel						
Shell Size	A B C D E F G H J K L M						
Cable Entry Code	See Table 1						
Band Strap Option	N = No Band (order band separately) M = Band included. Band-Master MicroBand, .125 (3.18) wide						
Height Code	In 1/16 inch increments. Example: 08 = .500 inch (12.7 mm.) See Table 2 for height codes.						

Table 1 Cable Entry Code

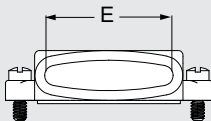

Cable Entry Code	E		Shell Size
	In.	mm.	
01	.255	6.48	A-M
02	.405	10.29	B-M
03	.555	14.10	C-M
04	.655	16.64	D-M
05	.805	20.45	E-M
06	.920	23.37	F-M
07	1.110	28.19	H-M
08	1.300	33.02	H-M
09	1.415	35.94	K-M
10	1.535	38.99	K-M
11	1.705	43.31	K
12	1.600	40.64	K and M

Table 2 Height Code

Height Code	Height		Shell Size Range		
	In.	mm.	Top Entry (T)	Side Entry (S)	45° Entry (E)
05	.313	7.95	—	A-F, J, K	—
06	.375	9.52	—	A-F, J, K	—
07	.438	11.13	—	A-L	—
08	.500	12.70	—	A-M	—
09	.563	14.30	A-F, J, K	A-M	—
10	.625	15.88	A-G, H, L	A-M	—
11	.688	17.48	A-M	A-M	A-F, J, K
12	.750	19.05	A-M	A-M	A-G, J, K
13	.813	20.65	A-M	—	A-L
14	.875	22.23	A-M	—	A-M
15	.938	23.83	A-M	—	A-M
16	1.000	25.40	A-M	—	A-M
17	1.063	27.00	A-M	—	A-M
18	1.125	28.58	A-M	—	G, H, L, M
19	1.188	30.18	G, H, L, M	—	G, H, L, M
20	1.250	31.75	G, H, L, M	—	G, H, L, M
21	1.313	33.35	G, H, L, M	—	G, H, L, M
22	1.375	34.93	G, H, L, M	—	—

Backshells for Series 791 Connectors

799-016 EMI Banding Adapter for 791-019 and 791-020 Panel Mount Connectors

Style T - Top Entry

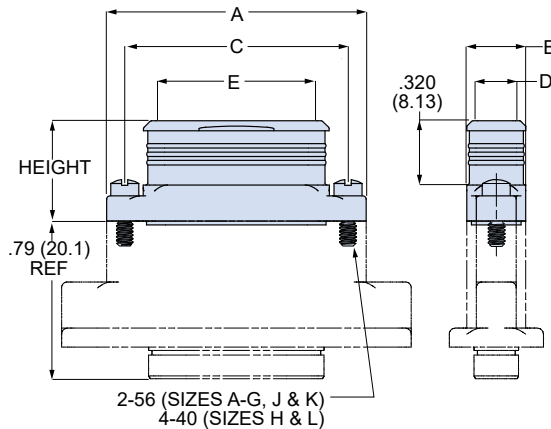

Style E - 45° Entry

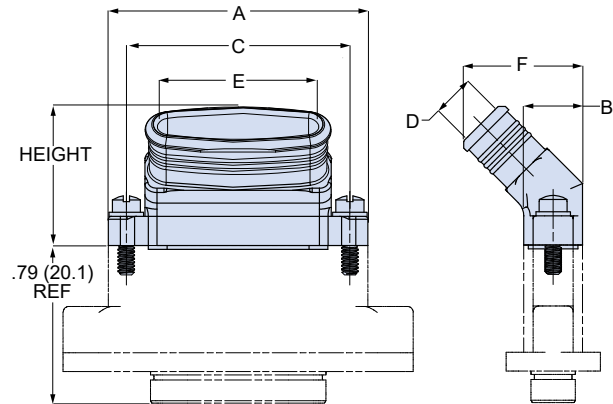

Style S - Side Entry

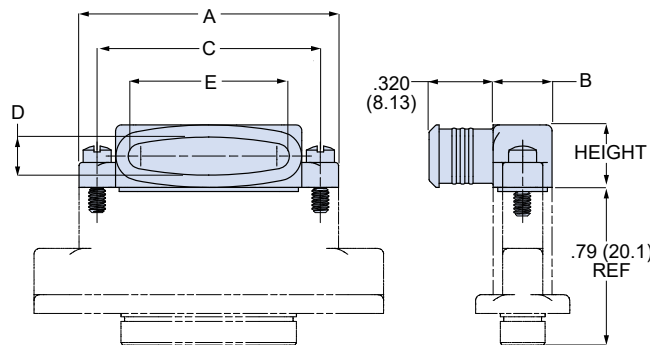

See previous page for height dimensions and cable entry (E) dimensions.

Dimensions

Shell Size	A Max.		B Max.		C		D		F		Available Entry Sizes
	In.	mm.	In.	mm.	In.	mm.	In.	mm.	In.	mm.	
A	.760	19.30	.308	7.82	.565	14.35	.190	4.83	.59	15.0	01
B	.910	23.11	.308	7.82	.715	18.16	.190	4.83	.59	15.0	01 thru 02
C	1.060	26.92	.308	7.82	.865	21.97	.190	4.83	.59	15.0	01 thru 03
D	1.160	29.46	.308	7.82	.965	24.51	.190	4.83	.59	15.0	01 thru 04
E	1.310	33.27	.308	7.82	1.115	28.32	.190	4.83	.59	15.0	01 thru 05
F	1.460	36.83	.308	7.82	1.265	32.13	.190	4.83	.59	15.0	01 thru 06
G	1.410	35.81	.395	10.03	1.215	30.86	.275	6.99	.68	17.3	01 thru 06
H	2.045	51.94	.410	10.41	1.800	45.72	.300	7.62	.70	17.8	01 thru 08
J	1.810	45.97	.308	7.82	1.615	41.02	.190	4.83	.59	15.0	01 thru 08
K	2.210	56.13	.308	7.82	2.015	51.18	.190	4.83	.59	15.0	01 thru 12
L	2.281	57.94	.410	10.41	2.036	51.71	.300	7.62	.70	17.8	01 thru 10
M	2.445	62.10	.470	11.94	2.200	55.88	.360	9.14	.76	19.3	01 - 10, 12

Anti-Static Dust Caps for Series 791 Connectors

799-064 and 799-065 Dust Caps

Permanently anti-static. Non-sloughing. ESD Protection.

Black plastic dust caps fit Series 791 connectors. Molded from permanently anti-static LDPE, these caps protect connectors from contamination and static discharge. Friction fit.



Technical Data	
Specifications	Construction
<ul style="list-style-type: none"> Volume resistivity: 1E9 - 9.9E10 ohm.cm (ASTM D 256) Surface resistivity: 1E10 - 9.9E11 ohm/sq (ASTM D 257) Static decay: <2.0 seconds (MIL-PRF-81705, 5kV to 50V, 12% RH) 	<ul style="list-style-type: none"> Material: low density polyethylene (LDPE) Part marking: molded-in raised lettering

799-064 Plug Dust Caps for Series 791 Socket Connectors

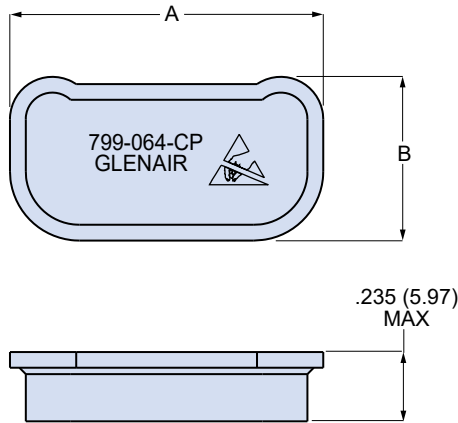

Shell Size	Dust Cap for Plug (Socket) Connectors	A Max		B Max	
		In.	mm.	In.	mm.
A	799-064A	.628	15.95	.524	13.31
B	799-064B	.778	19.76	.524	13.31
C	799-064C	.928	23.57	.524	13.31
D	799-064D	1.003	25.48	.524	13.31
E	799-064E	1.153	29.29	.524	13.31
F	799-064F	1.303	33.10	.524	13.31
G	799-064G	1.265	32.13	.612	15.54
H	799-064H	1.655	42.03	.630	16.00
J	799-064J	1.678	42.62	.524	13.31
K	799-064K	2.053	52.15	.524	13.31
L	799-064L	1.891	48.03	.630	16.00
M	799-064M	1.952	49.58	.714	18.14

799-065 Receptacle Dust Caps for Series 791 Pin Connectors

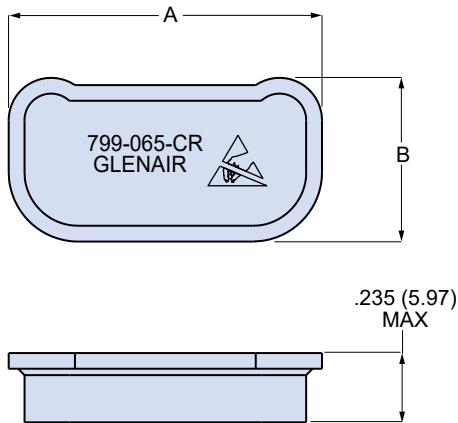

Shell Size	Dust Cap for Receptacle (Pin) Connectors	A Max		B Max	
		In.	mm.	In.	mm.
A	799-065A	.698	17.73	.594	15.09
B	799-065B	.848	21.54	.594	15.09
C	799-065C	.998	25.35	.594	15.09
D	799-065D	1.073	27.25	.594	15.09
E	799-065E	1.223	31.06	.594	15.09
F	799-065F	1.373	34.87	.594	15.09
G	799-065G	1.335	33.09	.682	17.32
H	799-065H	1.725	43.82	.700	17.78
J	799-065J	1.748	44.40	.594	15.09
K	799-065K	2.123	63.92	.594	15.09
L	799-065L	1.961	49.81	.700	17.78
M	799-065M	2.022	51.36	.784	19.91

Protective Covers for Series 791 Connectors

799-038 and 799-039 Metal Protective Covers



IP68 Ingress Protection. Conductive Rubber Gasket. Protect Series 791 connectors with metal covers. Conductive fluorosilicone rubber gasket prevents moisture intrusion. Plug cover has nickel-plated EMI spring.

Construction	
■	Shell: aluminum alloy
■	Gasket: conductive fluorosilicone
■	Ground spring: copper alloy, nickel plated

Table 2 Attachment Code

Ring Terminal		
Ring Code	Inside Diameter	
	In.	mm.
01	.126	3.20
02	.145	3.68
04	.188	4.78
06	.197	5.00

Solid Ring		
Ring Code	Inside Diameter	
	In.	mm.
14	.385	9.78
15	.445	11.30
16	.570	14.48
17	.635	16.13
18	.695	17.65
19	.885	22.48
20	1.070	27.18

Split Ring		
Ring Code	Inside Diameter	
	In.	mm.
50	.425	10.80
52	.485	12.32
54	.640	16.26
56	.750	19.05
58	.890	22.61
60	1.010	25.65
64	1.125	28.58
68	1.345	34.16

How To Order

Sample Part Number	799-038	M	H	P	G	6	-04
Product	799-038 = Receptacle cover 799-039 = Plug cover						
Shell Finish	M = Electroless Nickel MT = Nickel-PTFE ZR = Black Zinc-Nicke						
Shell Size	A B C D E F G H J K L M						
Jackscrew Option	L = Low profile jackscrew, hex head P = Female jackpost N = No locking hardware						
Attachment Type (Table 1)	N = No attachment G = Nylon rope SK = Nylon rope with slip knot U = SST rope with polyurethane coating H = SST rope with FEP jacket						
Attachment Length	Omit for attachment type N. Attachment length in inches.						
Attachment Ring Code (Table 2)	Omit for attachment types N and SK. See Table 2 for ring styles and sizes						

Table 1 Attachment Lanyards

<p>Nylon Rope (G) -55° to +100°C, black, very flexible, very good abrasion resistance, good resistance to fuels, .120" (3mm) diameter</p>	<p>Teflon® Jacketed Wire Rope (H) Translucent FEP jacket over stainless steel, -55° to +200°C, fair flexibility, good abrasion resistance, .100" diameter</p>
<p>Polyurethane Coated Wire Rope (U) Black polyurethane over stainless steel rope, -55° to +125°C, very flexible, excellent abrasion resistance, excellent resistance to fuels, .080" (2mm) diameter</p>	<p>Slip Knot (SK) 55° to +100°C, black, very flexible, very good abrasion resistance, good resistance to fuels, .120" (3mm) diameter. Length includes .5" (13mm) diameter loop.</p>

Protective Covers for Series 791 Connectors

799-038 and 799-039 Metal Protective Covers

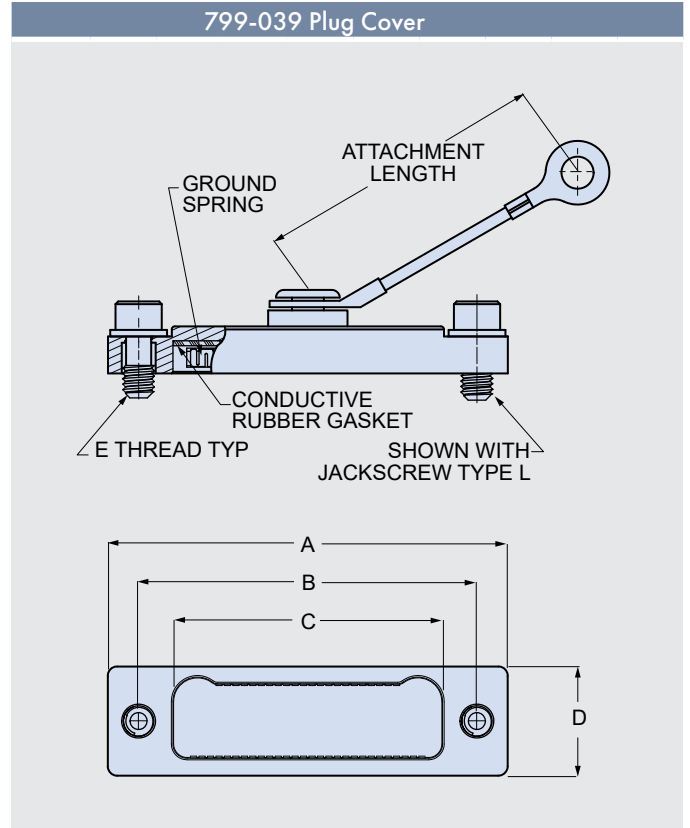
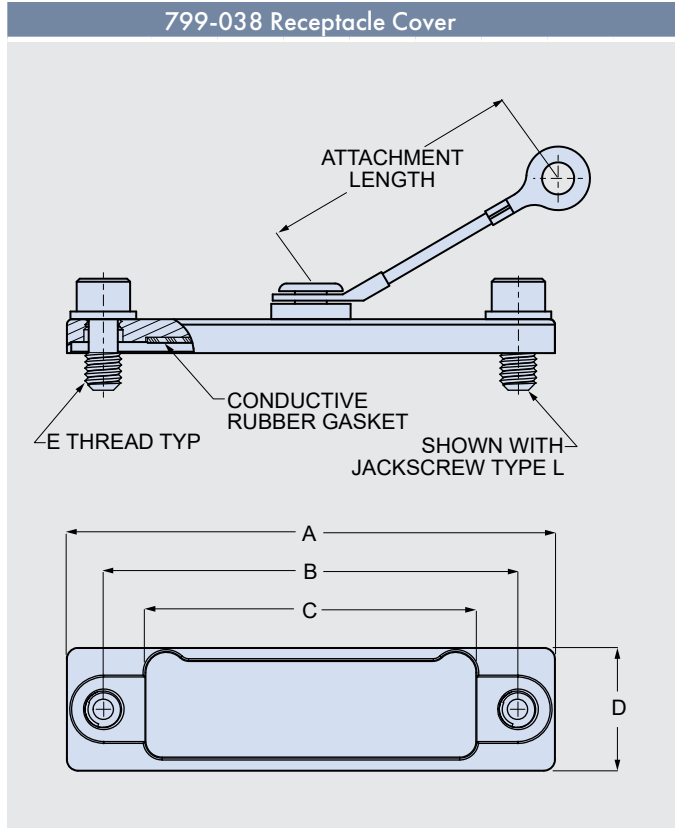

Dimensions

Shell Size	A		B		C Max		D Max		E Thd UNC
	In.	mm.	In.	mm.	In.	mm.	In.	mm.	
A	1.005	25.53	.750	19.05	.525	13.34	.500	12.70	4-40
B	1.155	29.34	.900	22.86	.675	17.15	.500	12.70	4-40
C	1.305	33.15	1.050	26.67	.825	20.96	.500	12.70	4-40
D	1.380	35.05	1.125	28.58	.900	22.86	.500	12.70	4-40
E	1.530	38.86	1.275	32.39	1.050	26.67	.500	12.70	4-40
F	1.680	42.67	1.425	36.20	1.200	30.48	.500	12.70	4-40
G	1.643	41.73	1.388	35.26	1.162	29.17	.595	15.11	4-40
H	2.295	58.29	1.900	48.26	1.556	39.52	.615	15.62	6-32
J	2.055	52.20	1.800	45.72	1.575	40.01	.500	12.70	4-40
K	2.430	61.72	2.175	55.25	1.950	49.53	.500	12.70	4-40
L	2.531	64.29	2.136	54.25	1.792	45.52	.615	15.62	6-32
M	2.600	66.04	2.200	55.88	1.855	47.12	.710	16.76	8-32

Dimensions

Shell Size	A		B		C Max		D Max		E Thd UNC
	In.	mm.	In.	mm.	In.	mm.	In.	mm.	
A	.975	24.77	.750	19.05	.448	11.30	.415	10.54	4-40
B	1.125	28.58	.900	22.86	.595	15.11	.415	10.54	4-40
C	1.275	32.39	1.050	26.67	.745	18.92	.415	10.54	4-40
D	1.350	34.29	1.125	28.58	.820	20.83	.415	10.54	4-40
E	1.500	38.10	1.275	32.39	.970	24.64	.415	10.54	4-40
F	1.650	41.91	1.425	36.20	1.120	28.45	.415	10.54	4-40
G	1.608	40.84	1.388	35.26	1.082	27.48	.500	12.70	4-40
H	2.275	57.79	1.900	48.26	1.472	37.39	.520	13.21	6-32
J	2.025	51.44	1.800	45.72	1.495	37.97	.415	10.54	4-40
K	2.400	60.96	2.175	55.25	1.865	47.37	.415	10.54	4-40
L	2.511	63.78	2.136	54.25	1.708	43.38	.520	13.21	6-32
M	2.515	63.88	2.200	55.88	1.769	44.95	.610	15.49	8-32

PCB Hole Patterns for Series 791 Connectors

Straight PCB Hole Patterns

PCB Hole Patterns for Straight PCB Series 791 Connectors

PCB hole patterns are shown for the *component mounting side* of the circuit board. The dotted line shows the orientation of the connector shell.

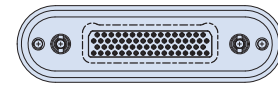

Top View

A-5 Arrangement

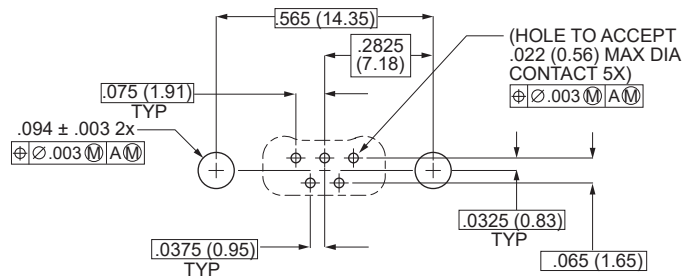
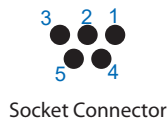

B-2P2 Arrangement

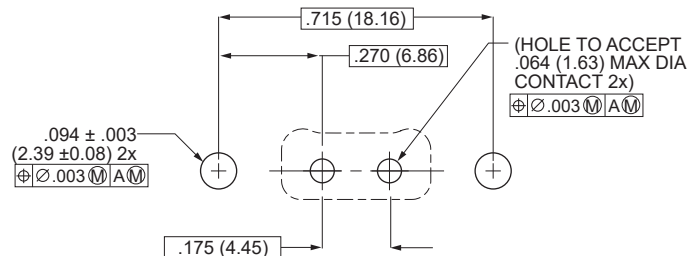
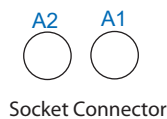
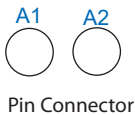

B-9 Arrangement

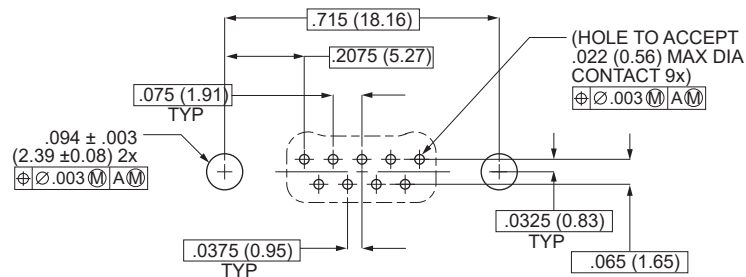

C-13 Arrangement

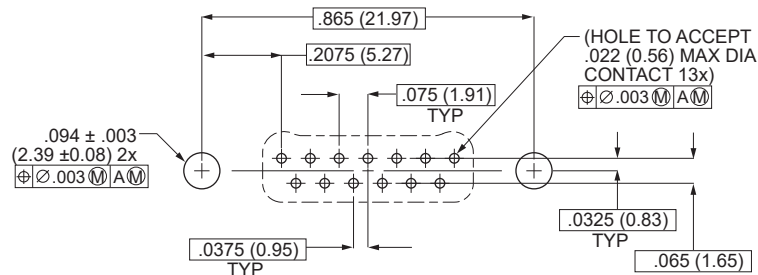

PCB Hole Patterns for Series 791 Connectors

Straight PCB Hole Patterns

PCB Hole Patterns for Straight PCB Series 791 Connectors

PCB hole patterns are shown for the *component mounting side* of the circuit board. The dotted line shows the orientation of the connector shell.

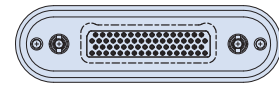

Top View

D-15 Arrangement



Pin Connector



Socket Connector

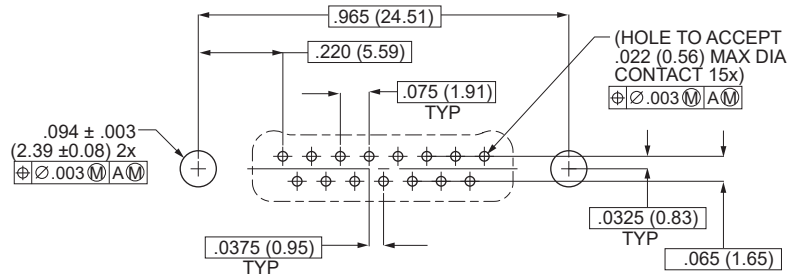

D-3P3 Arrangement

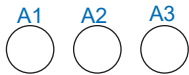

Pin Connector

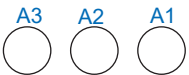

Socket Connector

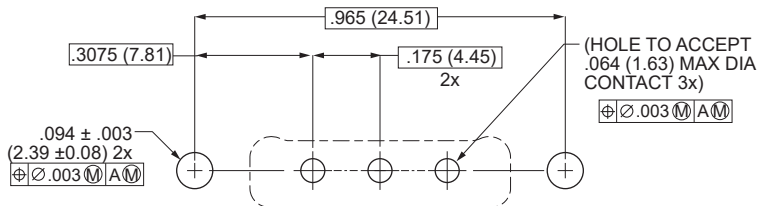

D-7P2 Arrangement

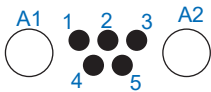

Pin Connector

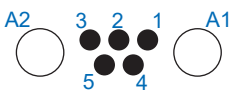

Socket Connector

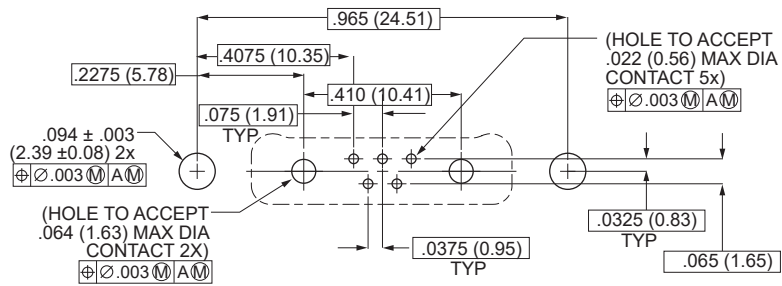

E-11P2 Arrangement



Pin Connector



Socket Connector

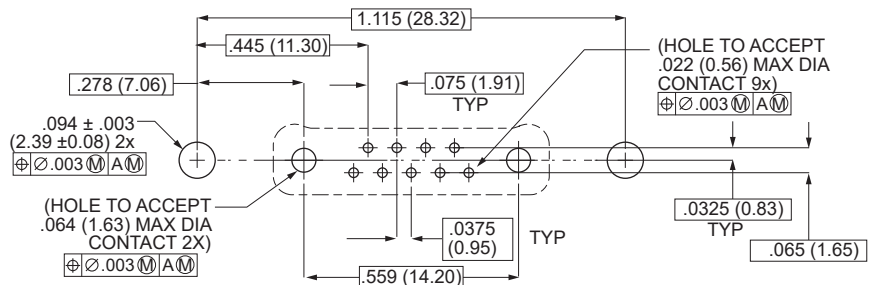

PCB Hole Patterns for Series 791 Connectors

Straight PCB Hole Patterns

PCB Hole Patterns for Straight PCB Series 791 Connectors

PCB hole patterns are shown for the *component mounting side* of the circuit board. The dotted line shows the orientation of the connector shell.

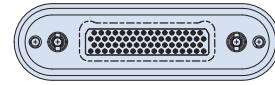

Top View

E-19 Arrangement



Pin Connector



Socket Connector

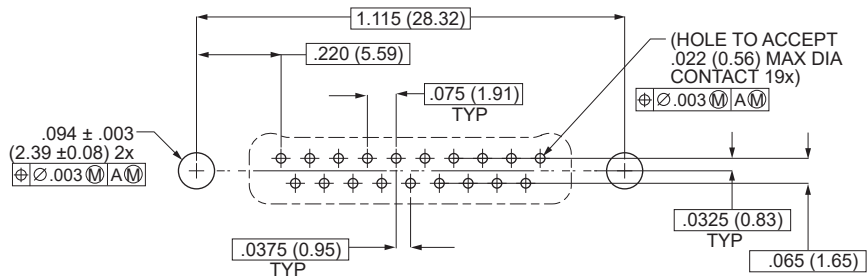

E-7P3 Arrangement

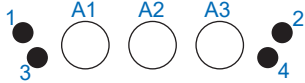

Pin Connector



Socket Connector

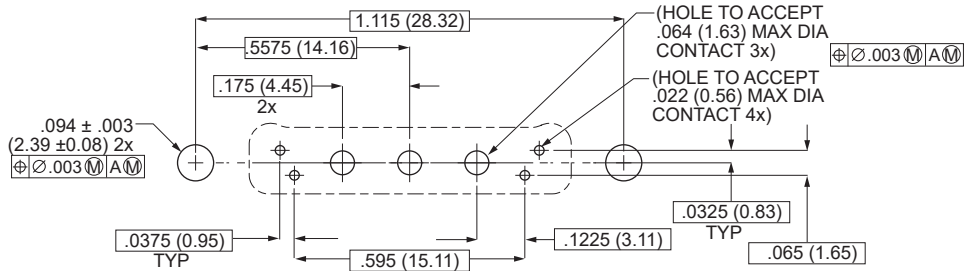

F-14P3P Arrangement

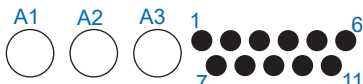

Pin Connector

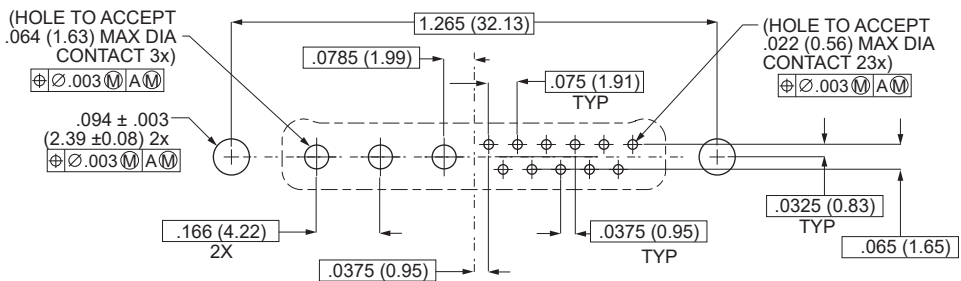

F-14P3S Arrangement

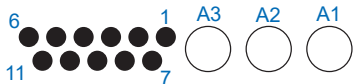

Socket Connector

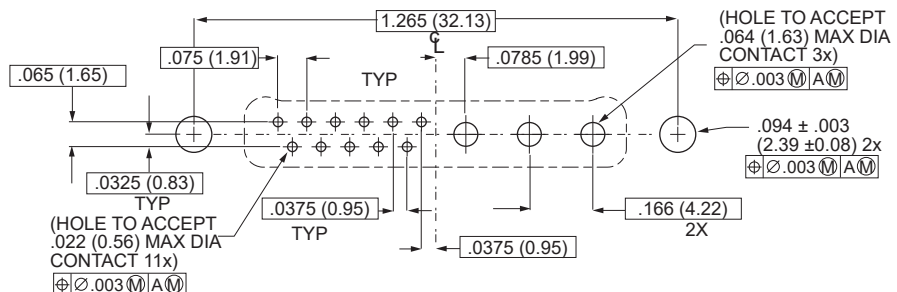

PCB Hole Patterns for Series 791 Connectors

Straight PCB Hole Patterns

PCB Hole Patterns for Straight PCB Series 791 Connectors

PCB hole patterns are shown for the *component mounting side* of the circuit board. The dotted line shows the orientation of the connector shell.

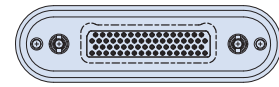

Top View

F-15P2 Arrangement

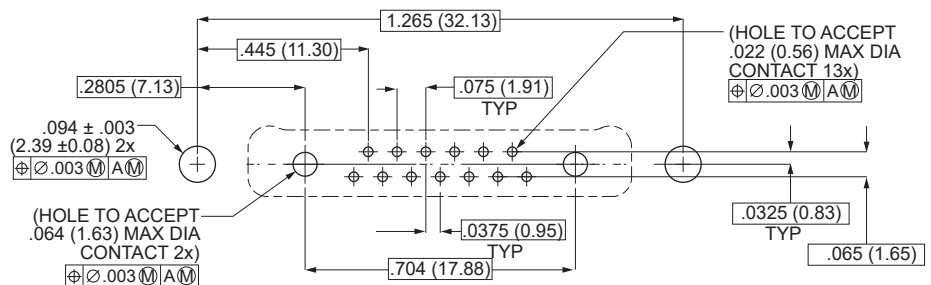
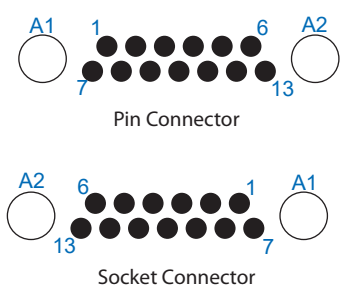

F-23 Arrangement

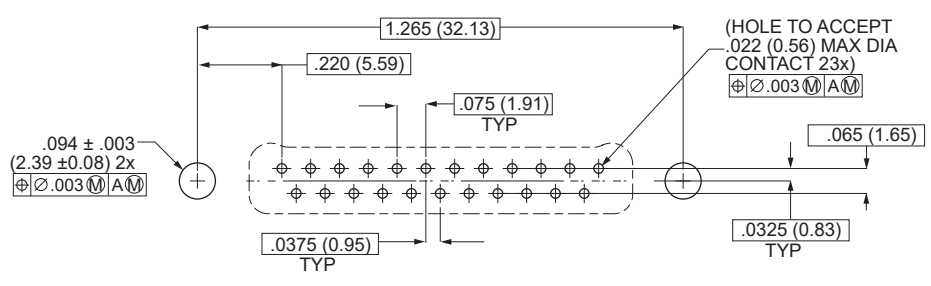
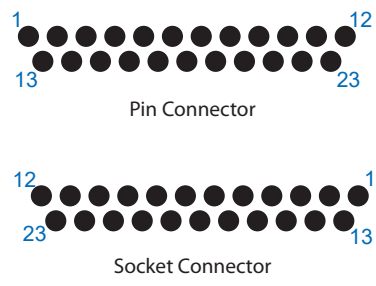

F-5P5 Arrangement

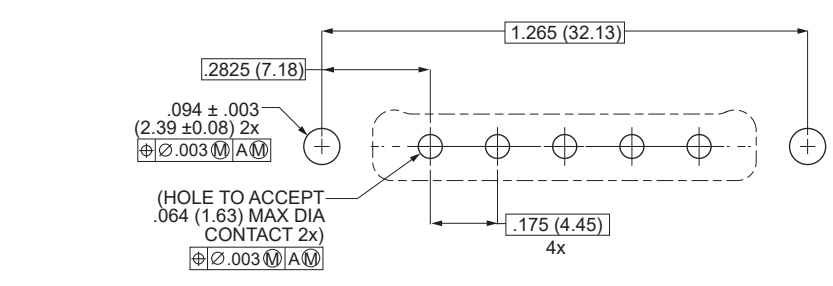
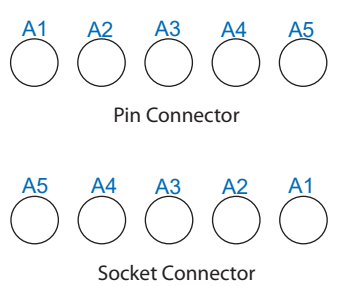

G-13P2 Arrangement

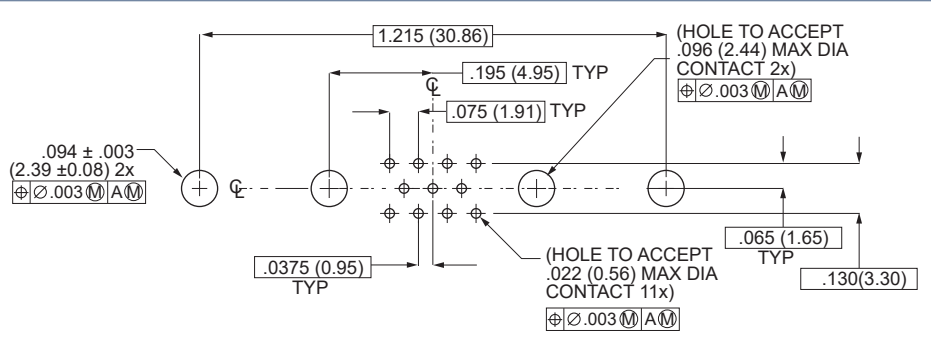
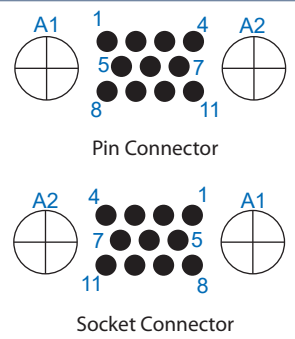

PCB Hole Patterns for Series 791 Connectors

Straight PCB Hole Patterns

PCB Hole Patterns for Straight PCB Series 791 Connectors

PCB hole patterns are shown for the *component mounting side* of the circuit board. The dotted line shows the orientation of the connector shell.

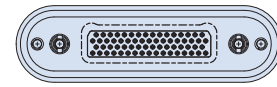

Top View

G-21P1 Arrangement

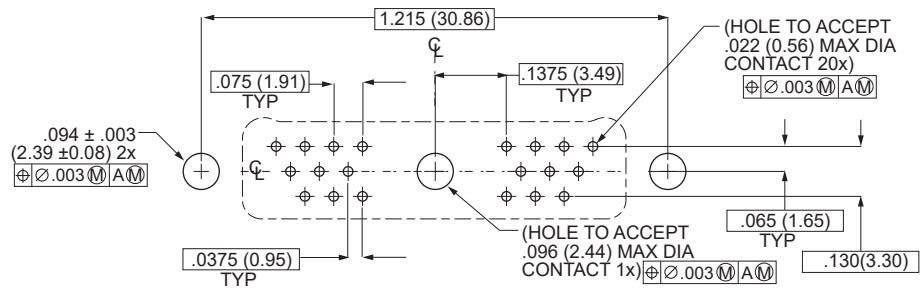
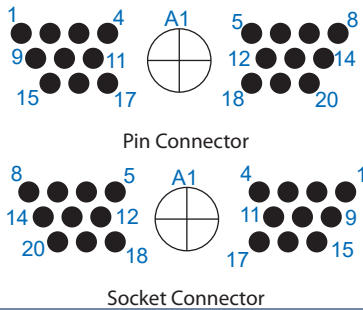

G-33 Arrangement

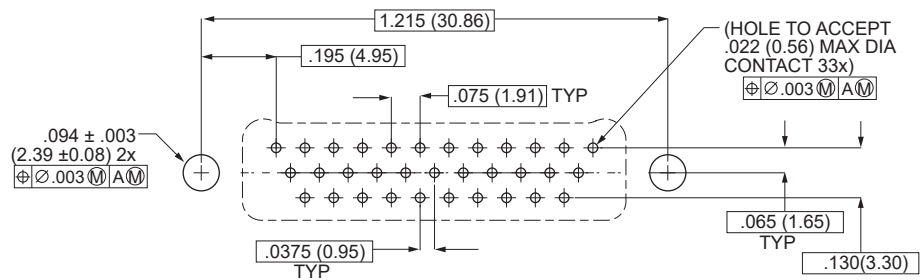
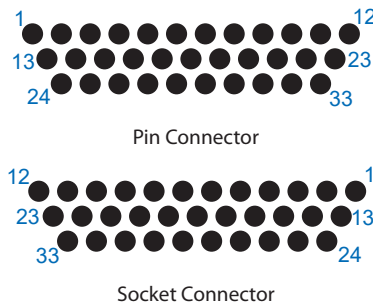

G-3P3 Arrangement

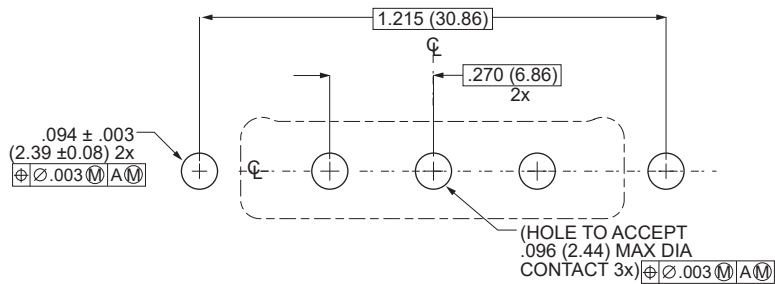
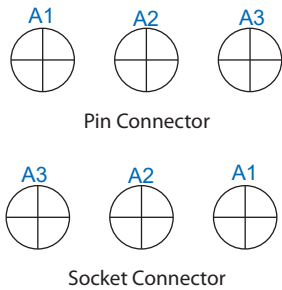

H-10P4 Arrangement

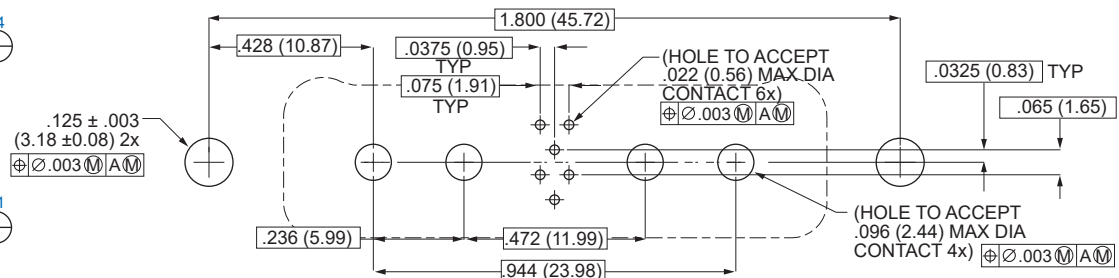
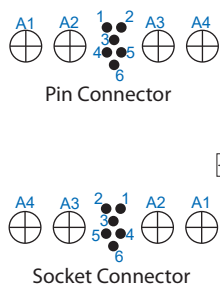

PCB Hole Patterns for Series 791 Connectors

Straight PCB Hole Patterns

PCB Hole Patterns for Straight PCB Series 791 Connectors

PCB hole patterns are shown for the *component mounting side* of the circuit board. The dotted line shows the orientation of the connector shell.

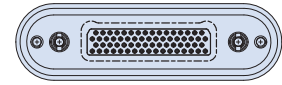

Top View

H-29P7 Arrangement

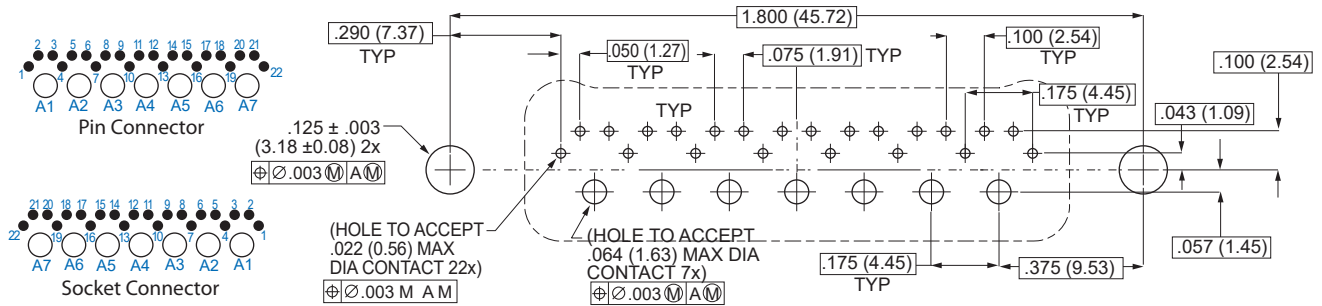

H-36P2 Arrangement

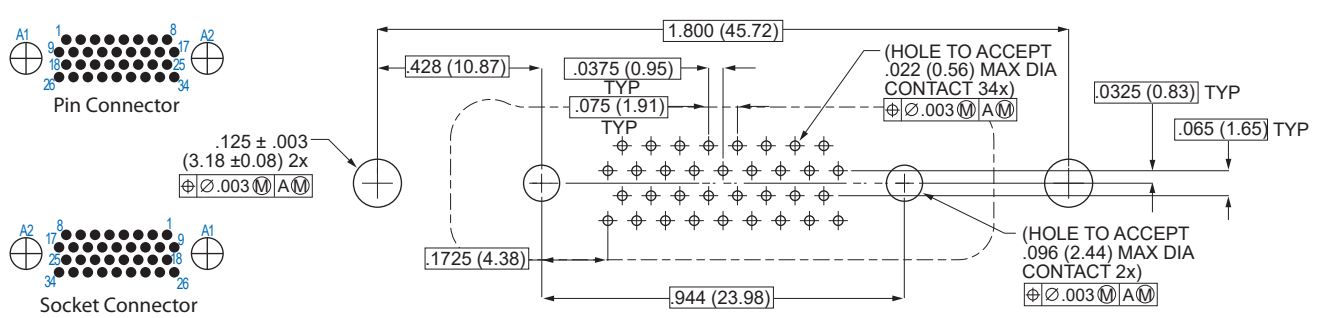

H-54P2 Arrangement

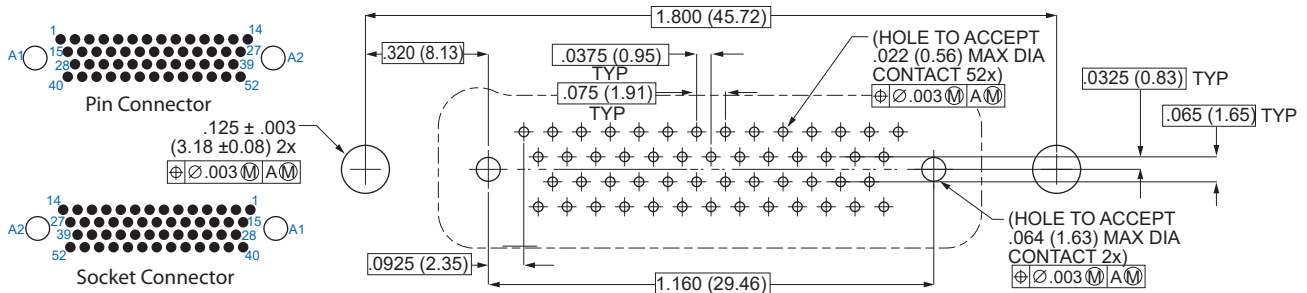

H-5P5 Arrangement

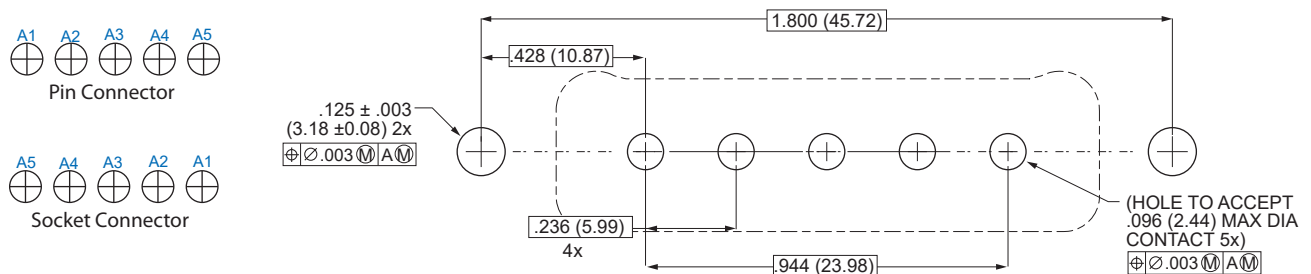

PCB Hole Patterns for Series 791 Connectors

Straight PCB Hole Patterns

PCB Hole Patterns for Straight PCB Series 791 Connectors

PCB hole patterns are shown for the *component mounting side* of the circuit board. The dotted line shows the orientation of the connector shell.

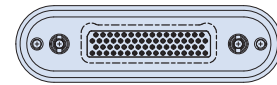

Top View

H-66 Arrangement

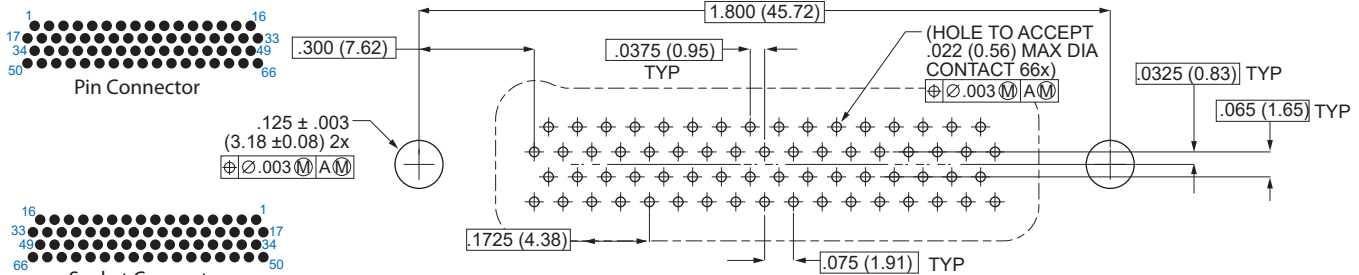

J-17P4 Arrangement

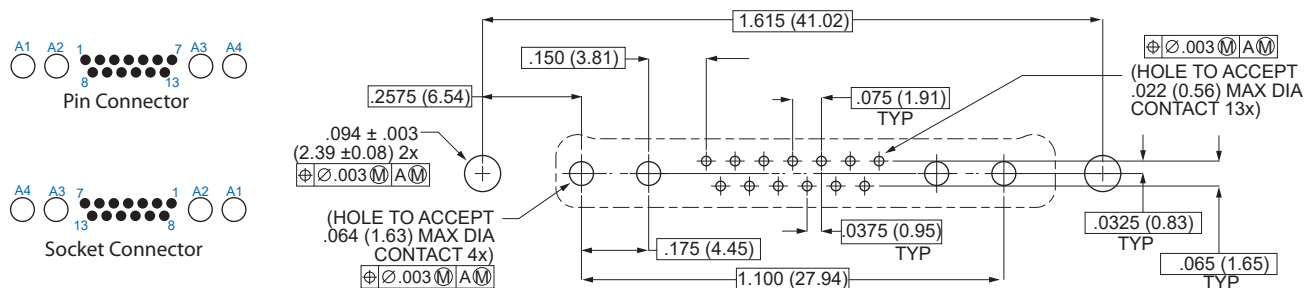

J-25P2 Arrangement

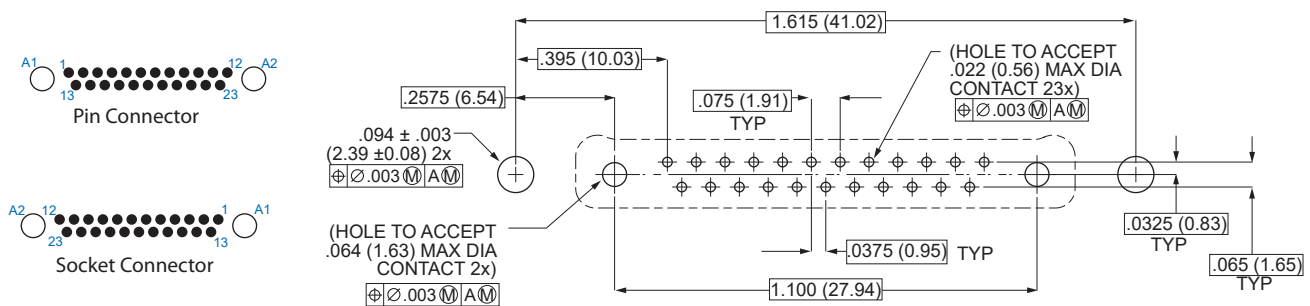

J-33 Arrangement

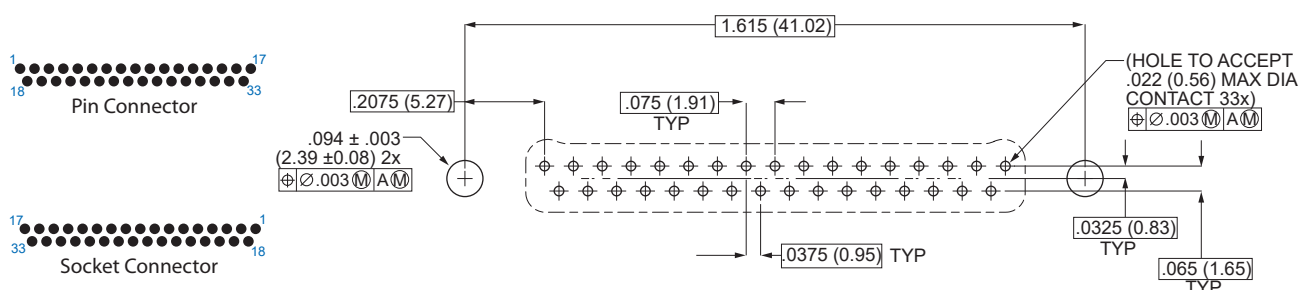

PCB Hole Patterns for Series 791 Connectors

Straight PCB Hole Patterns

PCB Hole Patterns for Straight PCB Series 791 Connectors

PCB hole patterns are shown for the *component mounting side* of the circuit board. The dotted line shows the orientation of the connector shell.

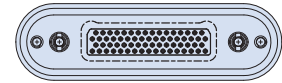

J-7P7 Arrangement

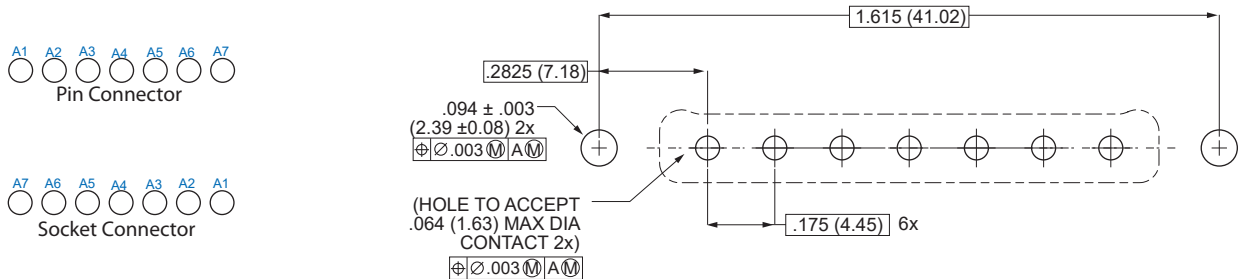

K-27P4 Arrangement

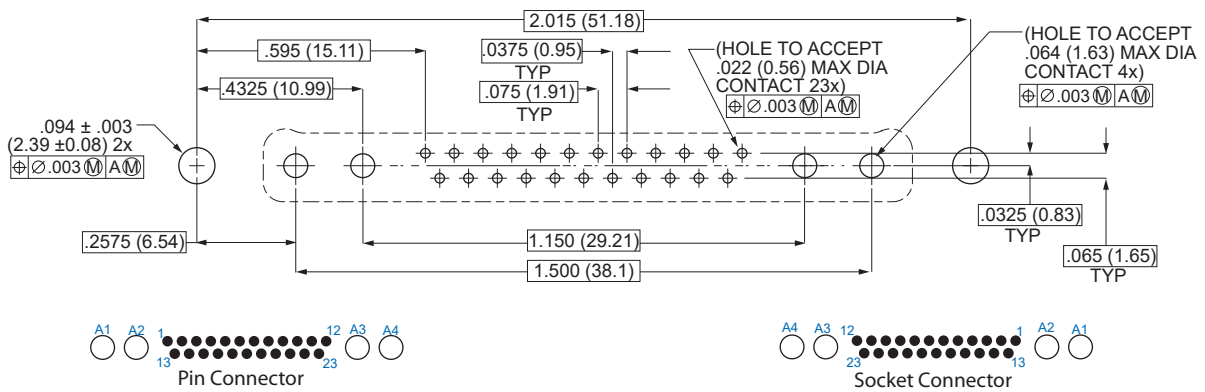

K-35P2 Arrangement

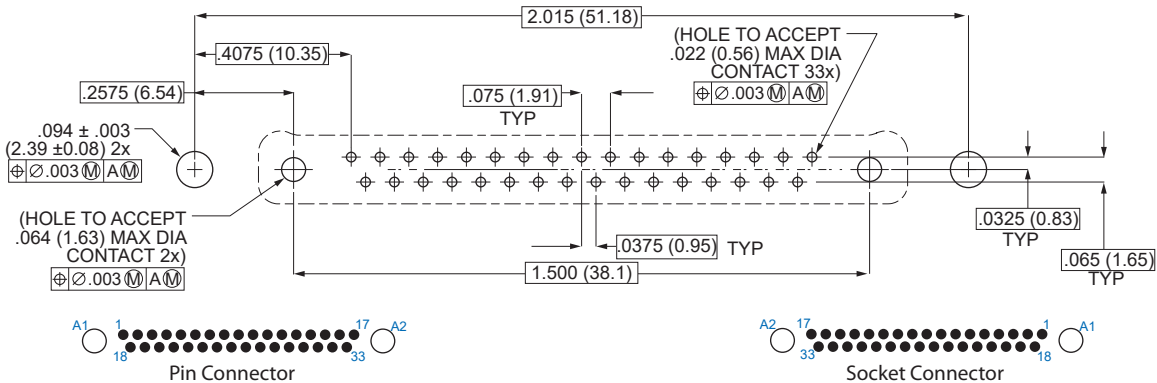

PCB Hole Patterns for Series 791 Connectors

Straight PCB Hole Patterns

PCB Hole Patterns for Straight PCB Series 791 Connectors

PCB hole patterns are shown for the *component mounting side* of the circuit board. The dotted line shows the orientation of the connector shell.

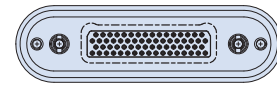

Top View

K-43 Arrangement

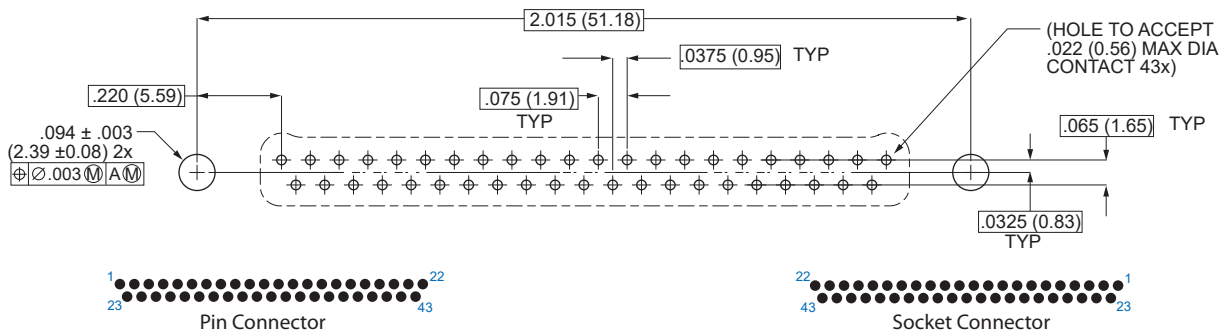

K-9P9 Arrangement

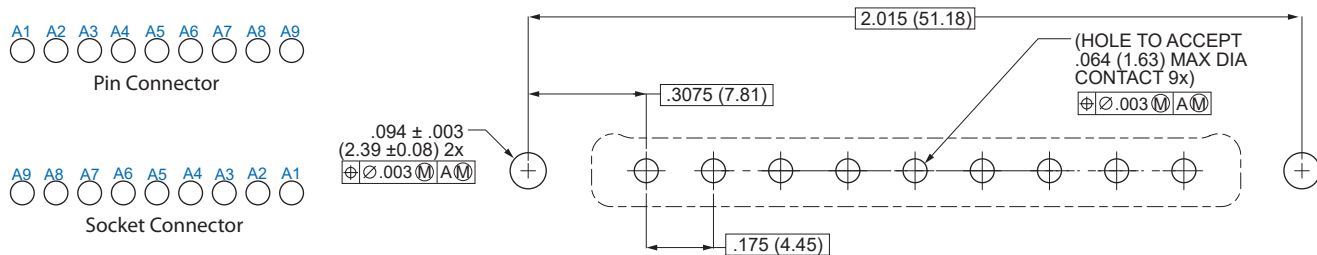

L-6P6 Arrangement

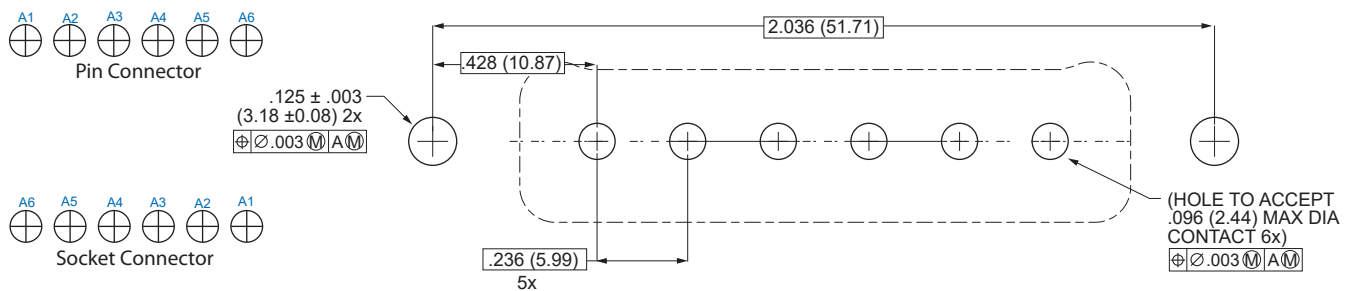

PCB Hole Patterns for Series 791 Connectors

Straight PCB Hole Patterns

PCB Hole Patterns for Straight PCB Series 791 Connectors

PCB hole patterns are shown for the *component mounting side* of the circuit board. The dotted line shows the orientation of the connector shell.

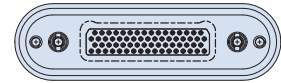

L-78 Arrangement

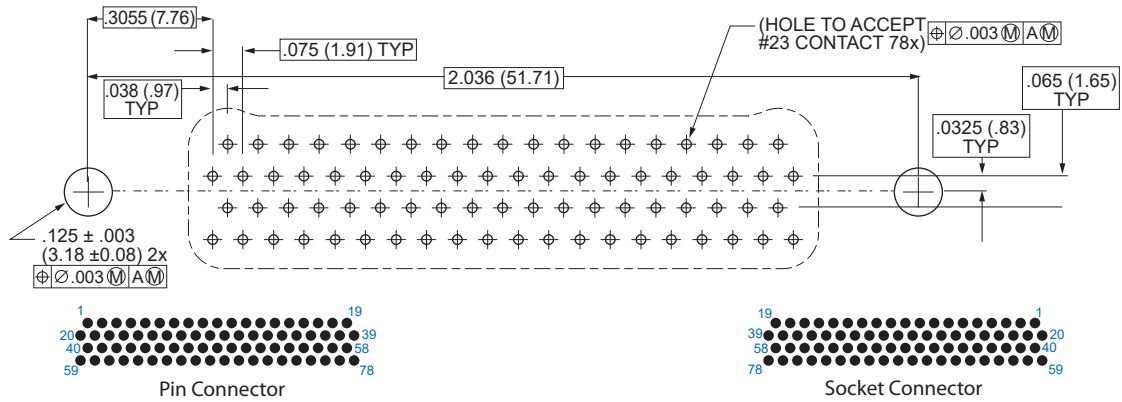

M-102 Arrangement

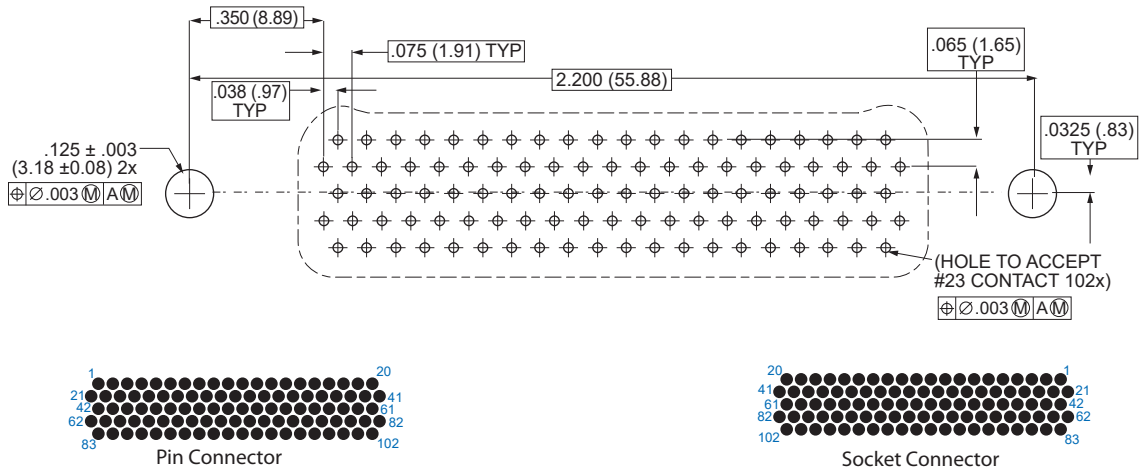

PCB Hole Patterns for Series 791 Connectors

Straight PCB Hole Patterns

PCB Hole Patterns for Straight PCB Series 791 Connectors

PCB hole patterns are shown for the *component mounting side* of the circuit board. The dotted line shows the orientation of the connector shell.

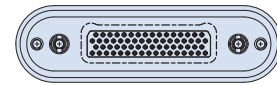

Top View

M-17P17 Arrangement

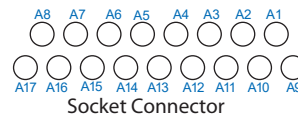
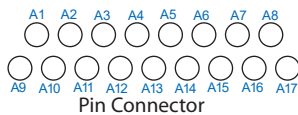
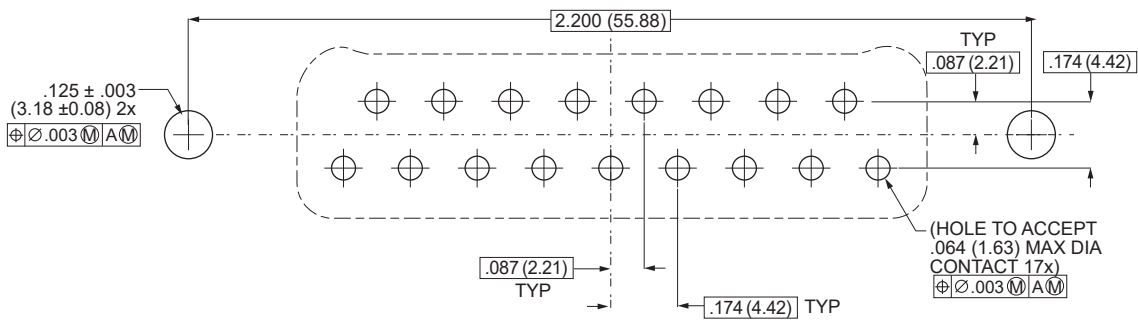

M-4P4 Arrangement

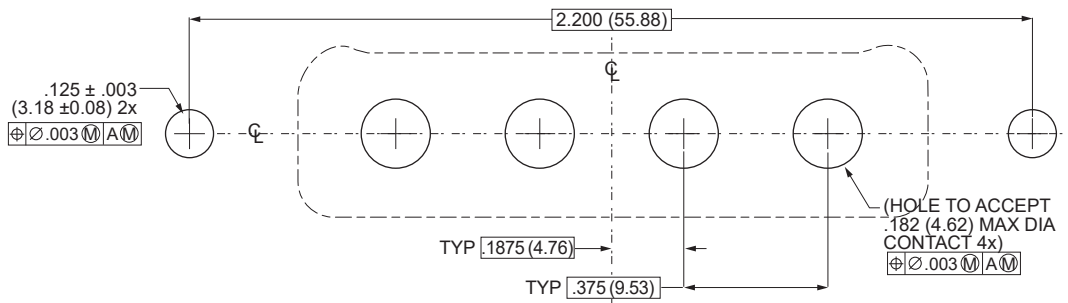

PCB Hole Patterns for Series 791 Connectors

Right Angle PCB Hole Patterns

PCB Hole Patterns for Right Angle Series 79 Connectors

Right angle PCB hole patterns are shown for the *component mounting side* of the circuit board. Connector orientation is shown in the illustration to the right with the connector facing up.

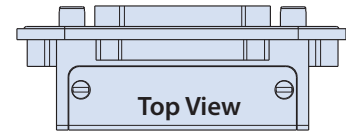

A-5 Arrangement

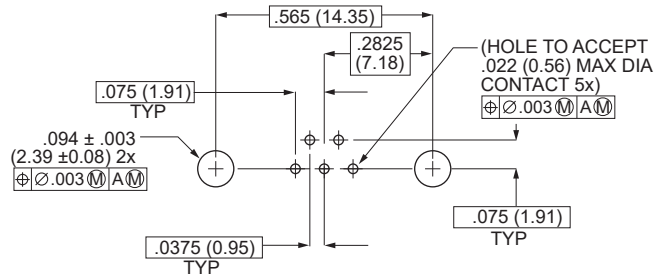
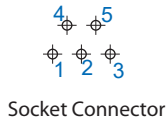

B-2P2 Arrangement

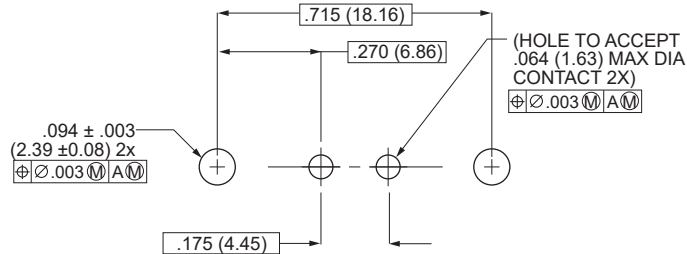

B-9 Arrangement

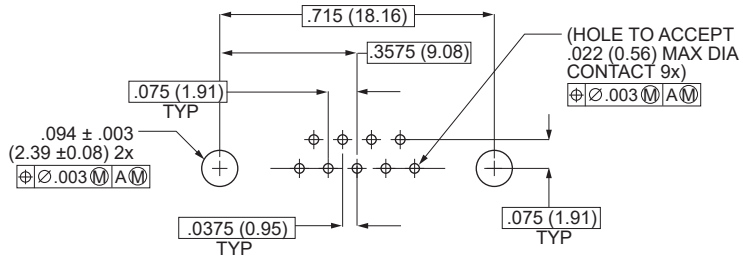

C-13 Arrangement

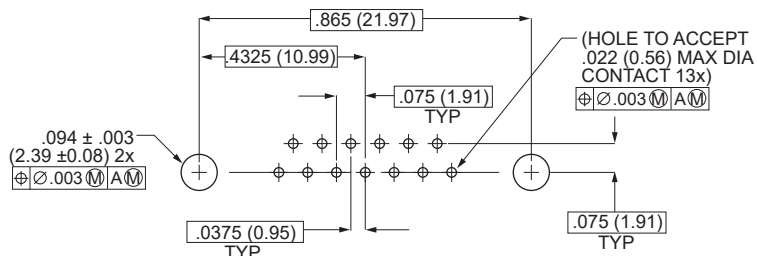
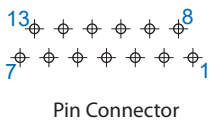

PCB Hole Patterns for Series 791 Connectors

Right Angle PCB Hole Patterns

PCB Hole Patterns for Right Angle Series 79 Connectors

Right angle PCB hole patterns are shown for the *component mounting side* of the circuit board. Connector orientation is shown in the illustration to the right with the connector facing up.

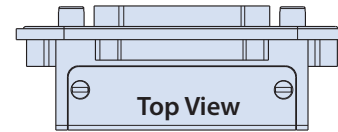

D-15 Arrangement



Pin Connector



Socket Connector

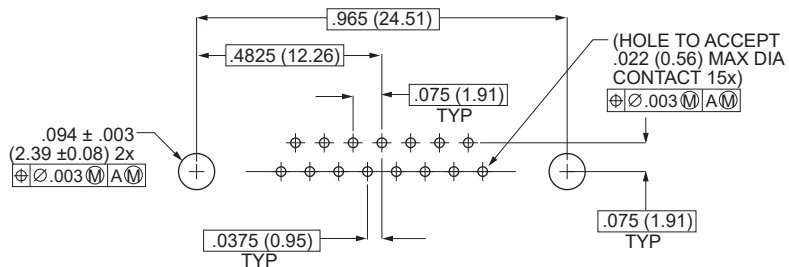

D-3P3 Arrangement



Pin Connector



Socket Connector

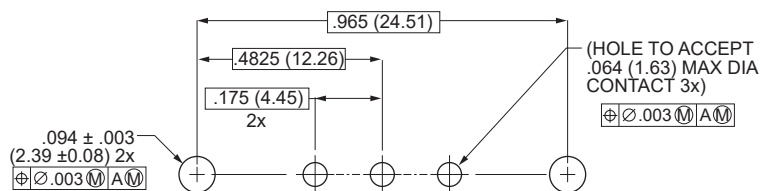

D-7P2 Arrangement



Pin Connector



Socket Connector

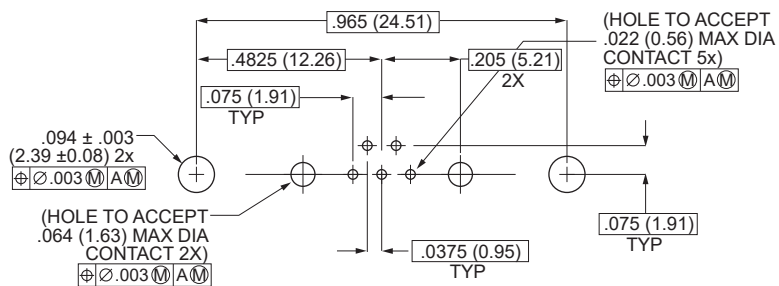

E-11P2 Arrangement



Pin Connector



Socket Connector

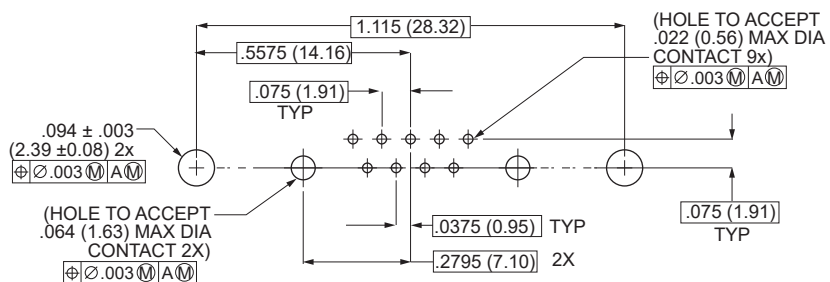

PCB Hole Patterns for Series 791 Connectors

Right Angle PCB Hole Patterns

PCB Hole Patterns for Right Angle Series 79 Connectors

Right angle PCB hole patterns are shown for the *component mounting side* of the circuit board. Connector orientation is shown in the illustration to the right with the connector facing up.

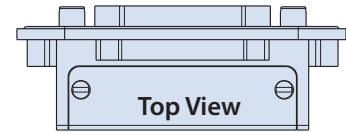

E-19 Arrangement

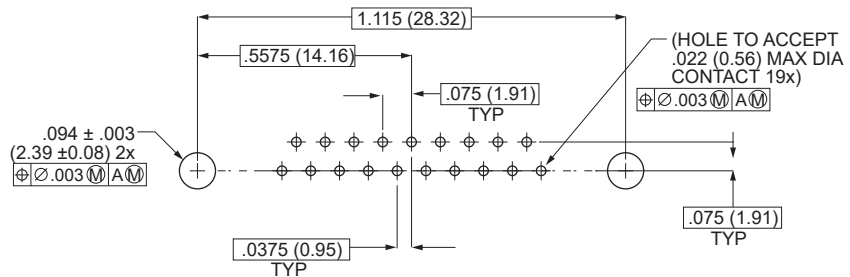
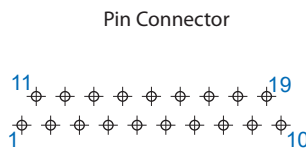

E-7P3 Arrangement

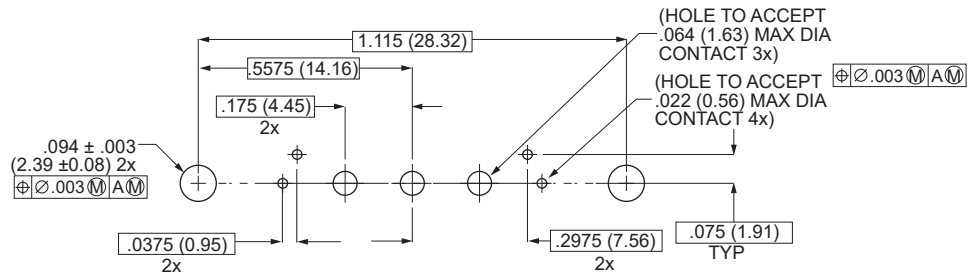
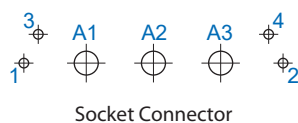

F-14P3P Arrangement



Pin Connector

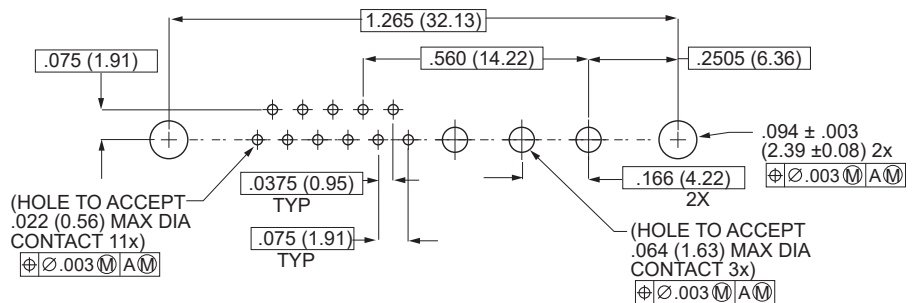

F-14P3S Arrangement

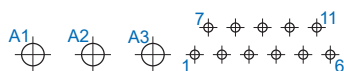

Socket Connector

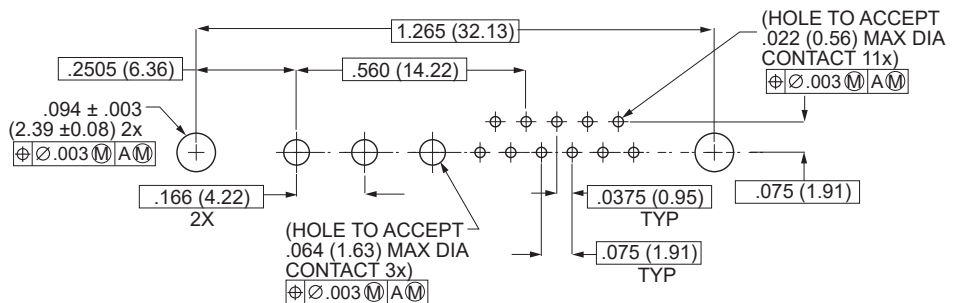

PCB Hole Patterns for Series 791 Connectors

Right Angle PCB Hole Patterns

PCB Hole Patterns for Right Angle Series 79 Connectors

Right angle PCB hole patterns are shown for the *component mounting side* of the circuit board. Connector orientation is shown in the illustration to the right with the connector facing up.

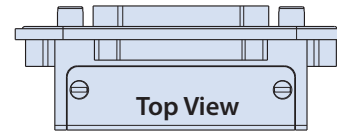

F-15P2 Arrangement

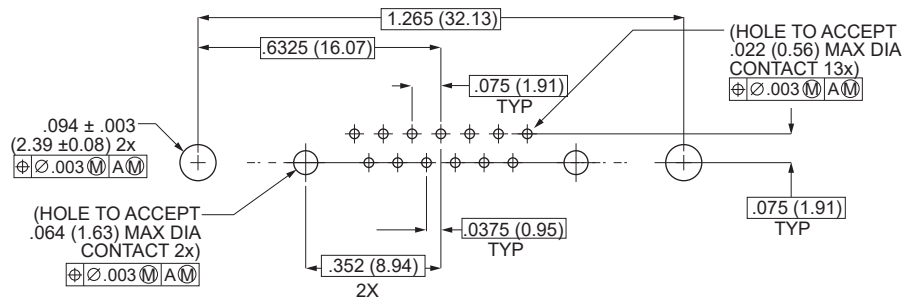
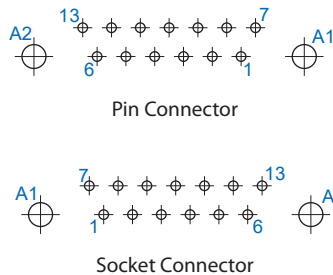

F-23 Arrangement

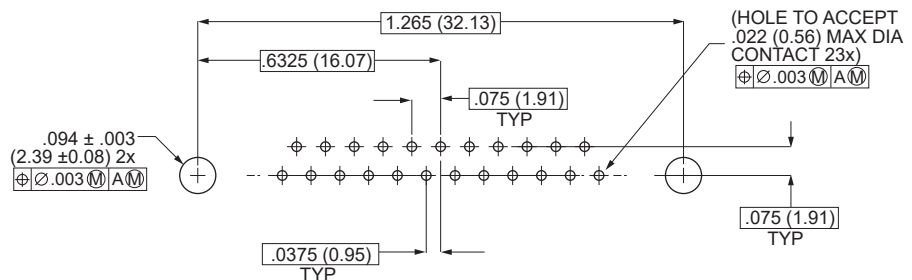
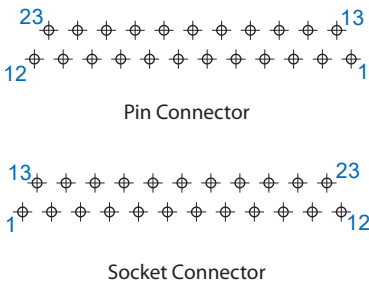

F-5P5 Arrangement

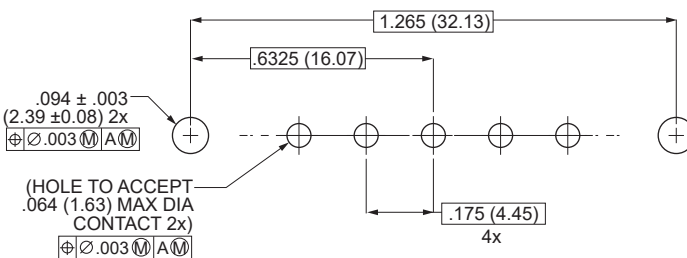
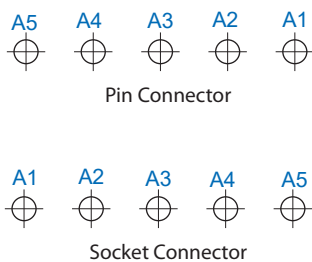

G-13P2 Arrangement

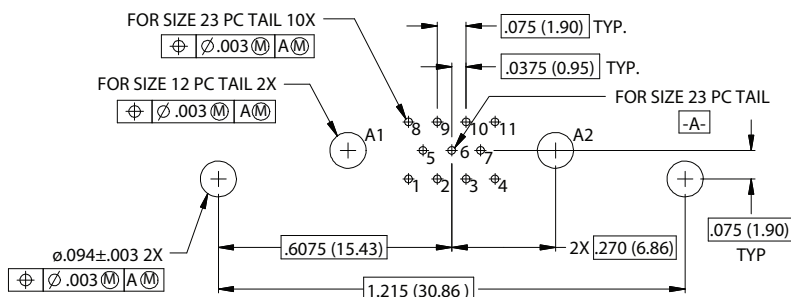
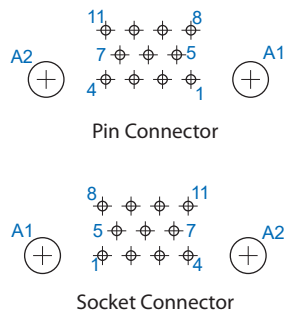

PCB Hole Patterns for Series 791 Connectors

Right Angle PCB Hole Patterns

PCB Hole Patterns for Right Angle Series 79 Connectors

Right angle PCB hole patterns are shown for the *component mounting side* of the circuit board. Connector orientation is shown in the illustration to the right with the connector facing up.

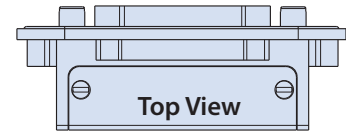

G-21P1 Arrangement

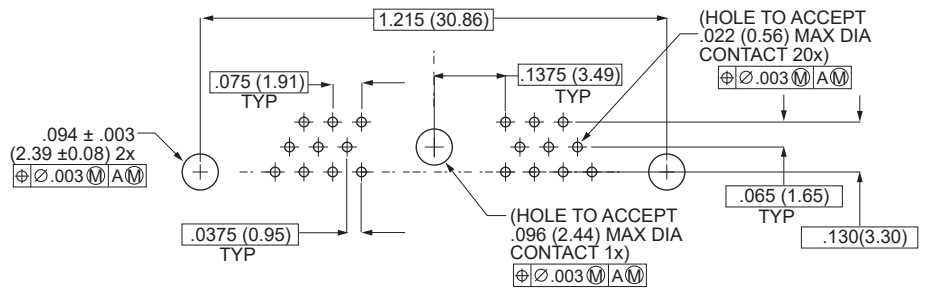
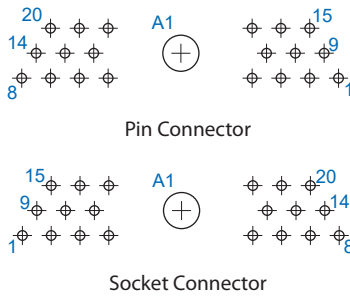

G-33 Arrangement

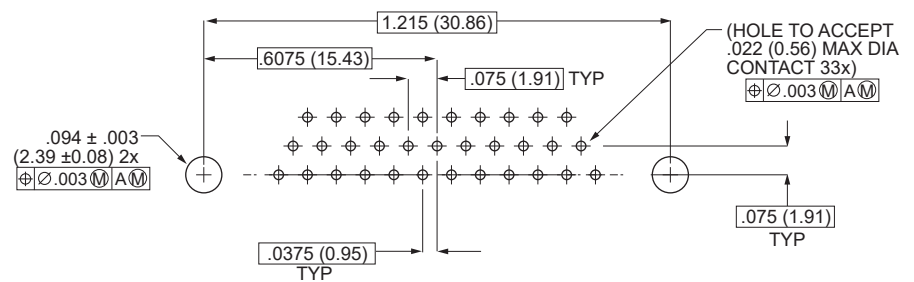
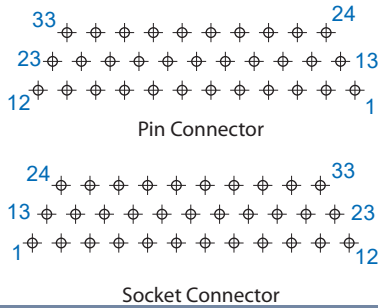

G-3P3 Arrangement

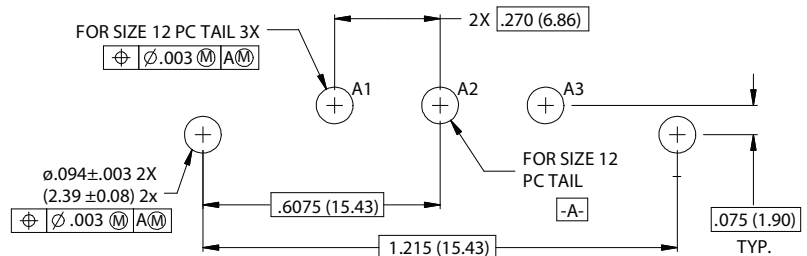
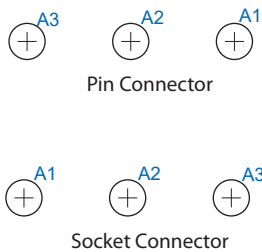

H-10P4 Arrangement

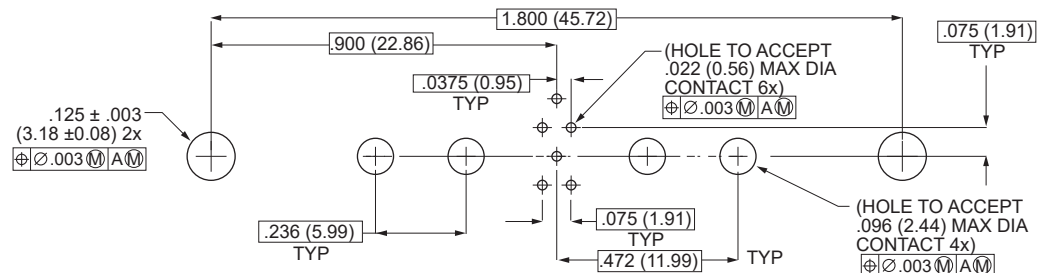
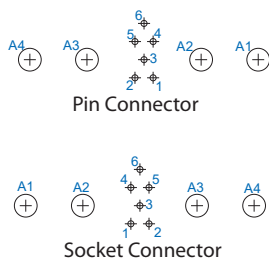

PCB Hole Patterns for Series 791 Connectors

Right Angle PCB Hole Patterns

PCB Hole Patterns for Right Angle Series 79 Connectors

Right angle PCB hole patterns are shown for the *component mounting side* of the circuit board. Connector orientation is shown in the illustration to the right with the connector facing up.

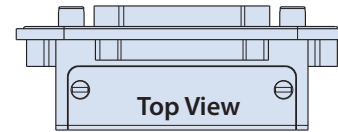

H-29P7 Arrangement

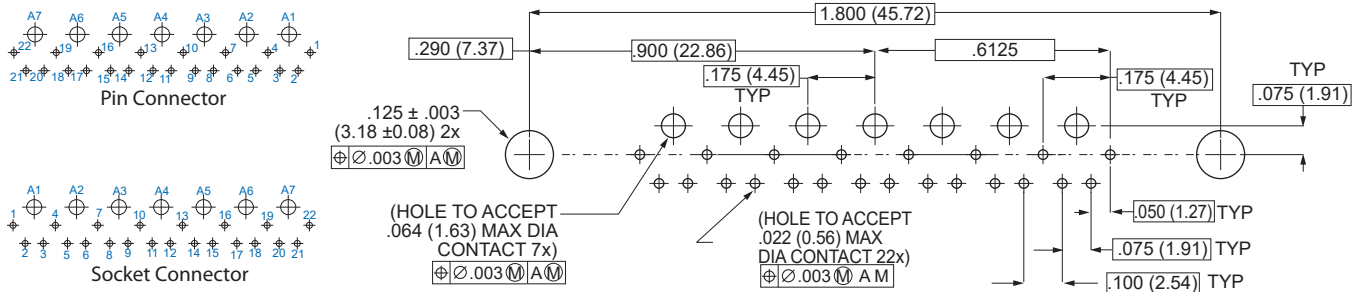

H-36P2 Arrangement

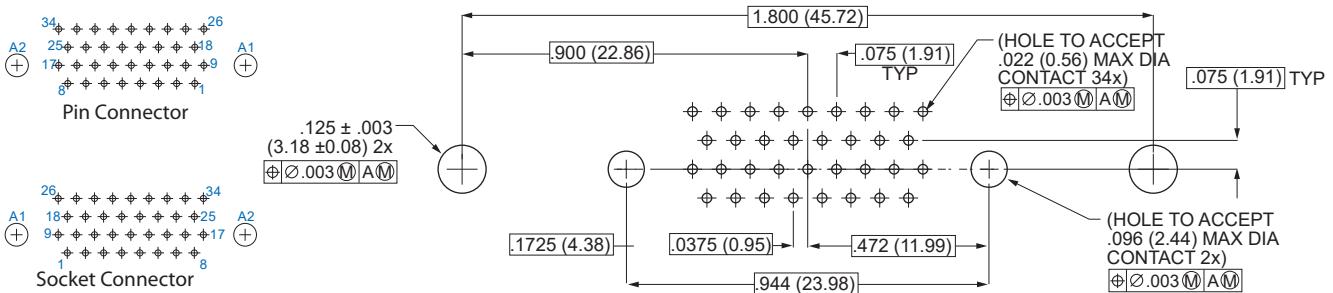

H-54P2 Arrangement

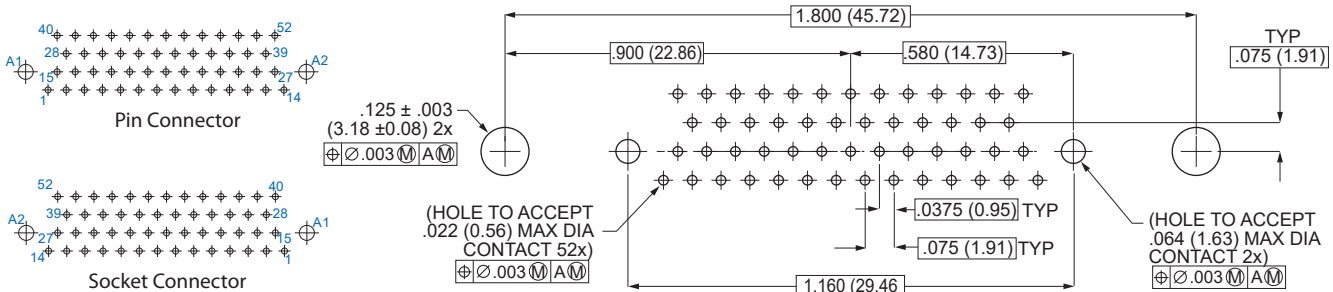

H-5P5 Arrangement

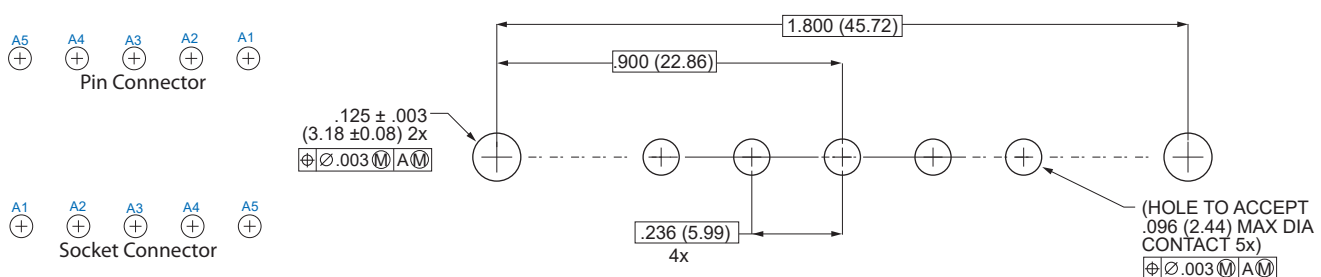

PCB Hole Patterns for Series 791 Connectors

Right Angle PCB Hole Patterns

PCB Hole Patterns for Right Angle Series 79 Connectors

Right angle PCB hole patterns are shown for the *component mounting side* of the circuit board. Connector orientation is shown in the illustration to the right with the connector facing up.

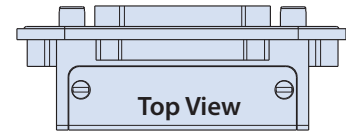

H-66 Arrangement

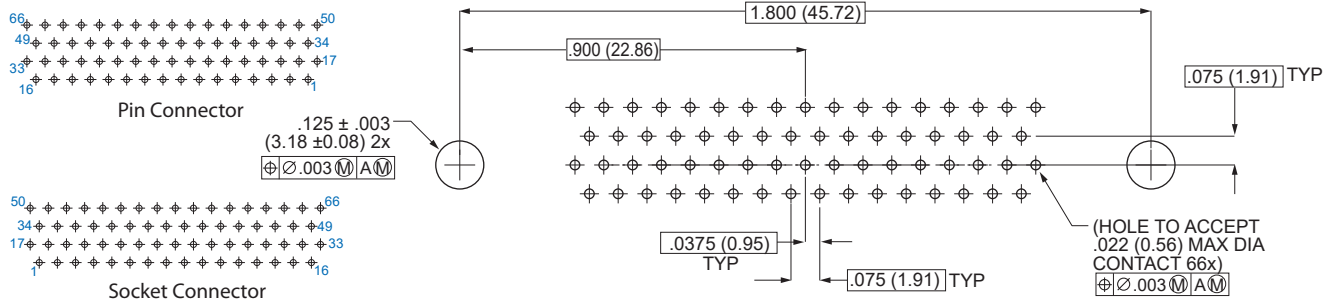

J-17P4 Arrangement

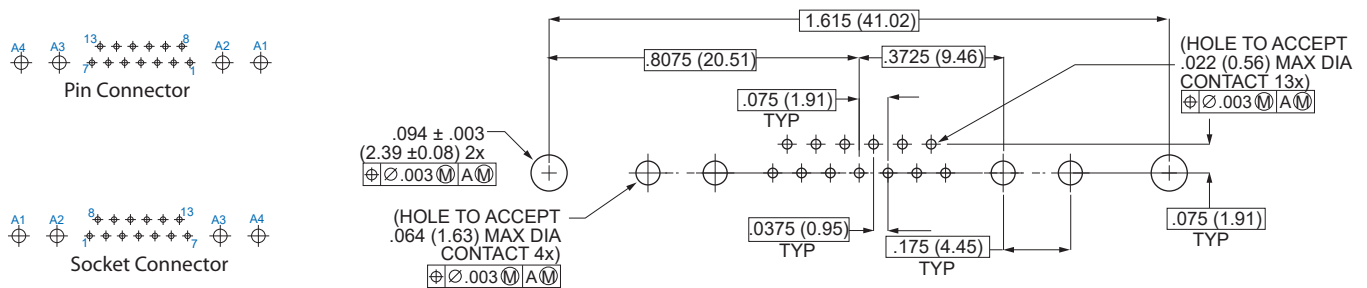

J-25P2 Arrangement

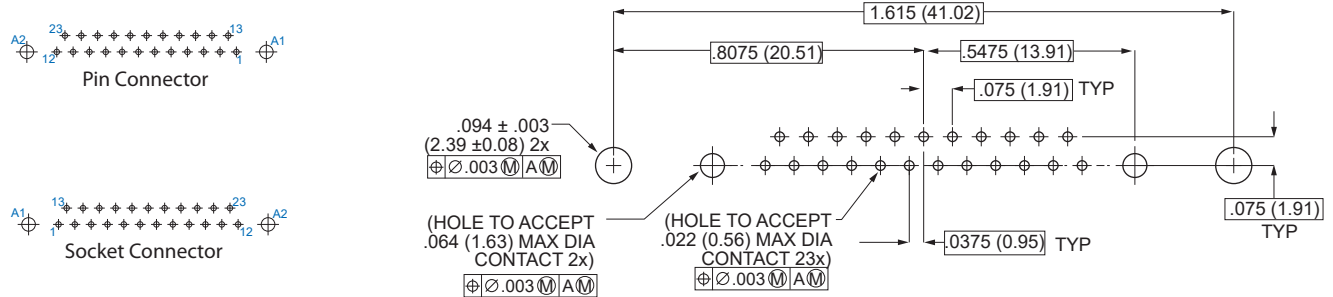

J-33 Arrangement

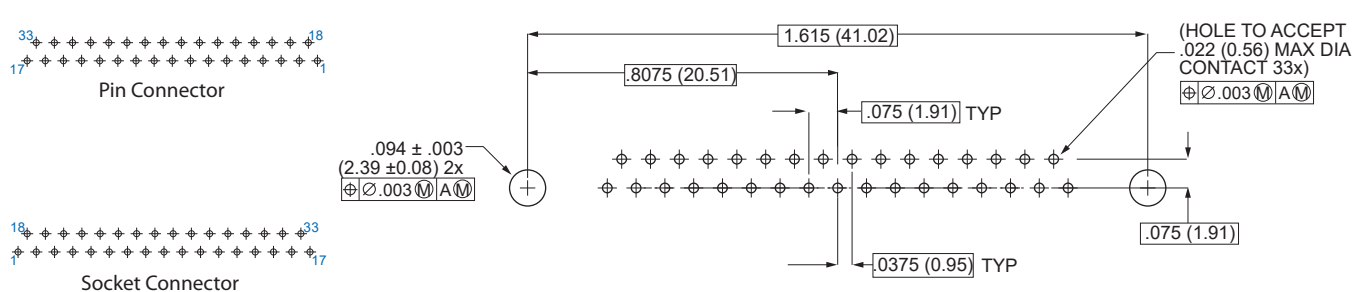

PCB Hole Patterns for Series 791 Connectors

Right Angle PCB Hole Patterns

PCB Hole Patterns for Right Angle Series 79 Connectors

Right angle PCB hole patterns are shown for the *component mounting side* of the circuit board. Connector orientation is shown in the illustration to the right with the connector facing up.

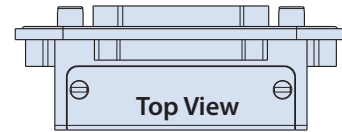

J-7P7 Arrangement

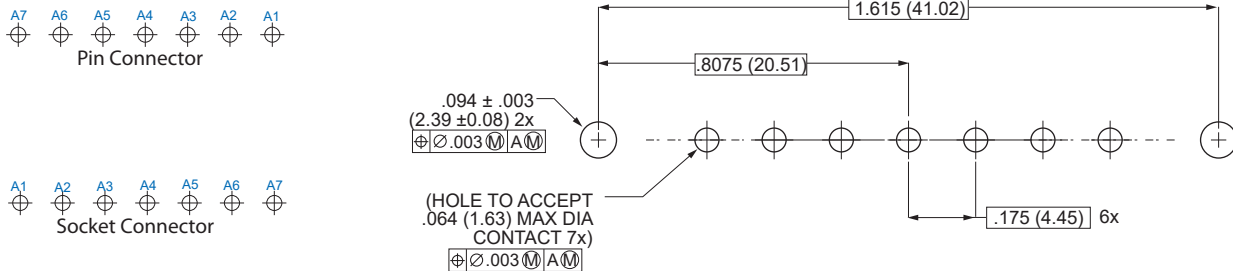

K-27P4 Arrangement

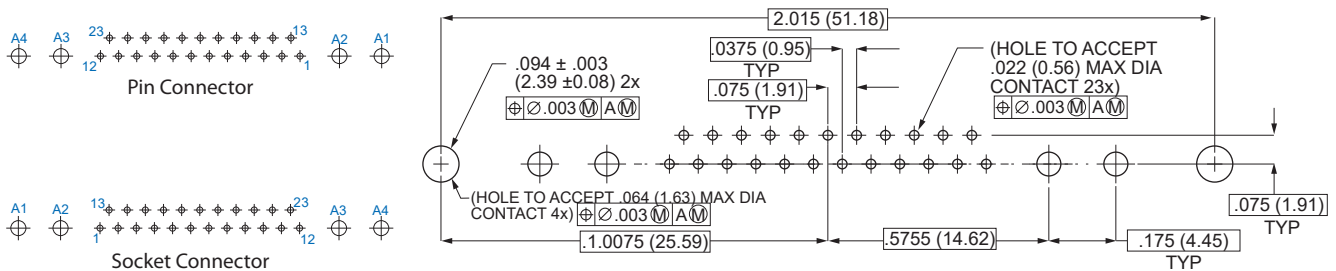

K-35P2 Arrangement

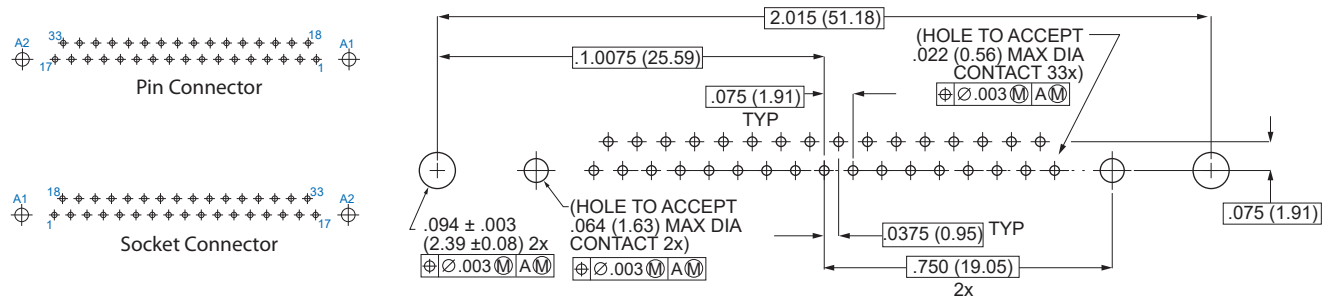

K-43 Arrangement

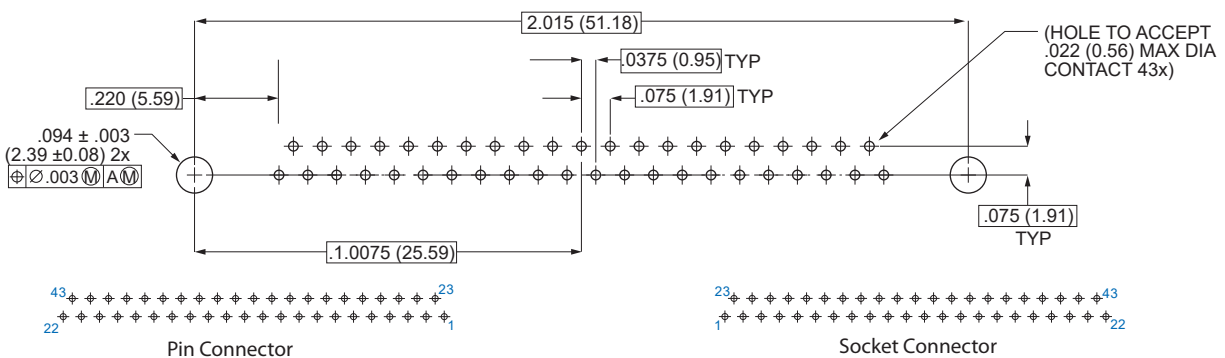

PCB Hole Patterns for Series 791 Connectors

Right Angle PCB Hole Patterns

PCB Hole Patterns for Right Angle Series 79 Connectors

Right angle PCB hole patterns are shown for the *component mounting side* of the circuit board. Connector orientation is shown in the illustration to the right with the connector facing up.

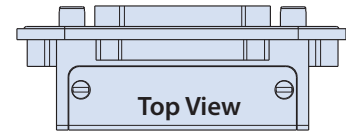

K-9P9 Arrangement

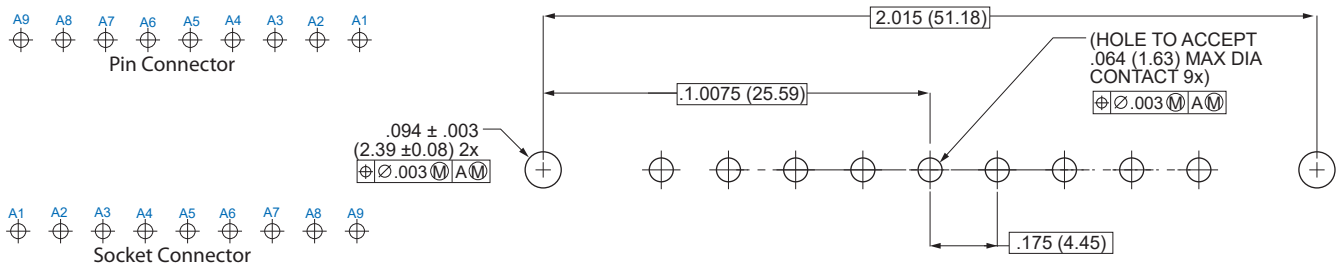

L-6P6 Arrangement

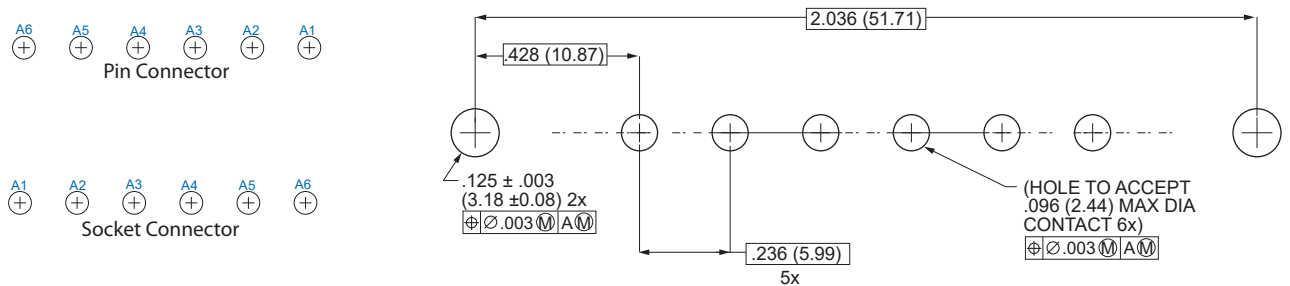

L-78 Arrangement

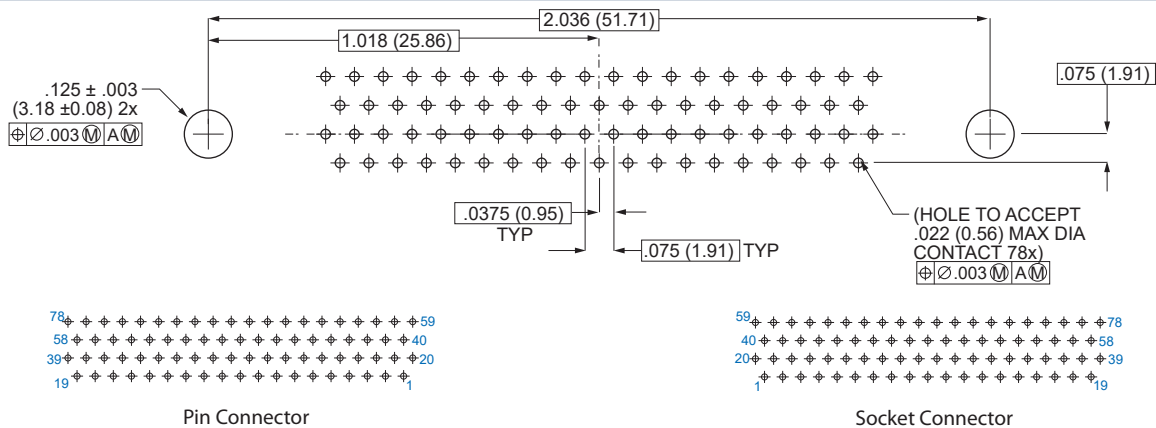

PCB Hole Patterns for Series 791 Connectors

Right Angle PCB Hole Patterns

PCB Hole Patterns for Right Angle Series 79 Connectors

Right angle PCB hole patterns are shown for the *component mounting side* of the circuit board. Connector orientation is shown in the illustration to the right with the connector facing up.

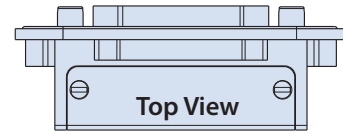

M-102 Arrangement

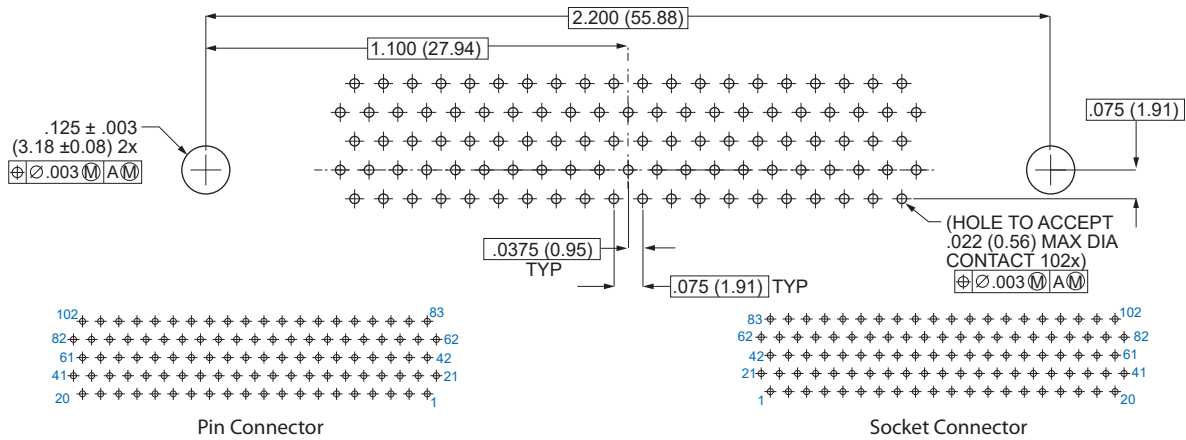

M-17P17 Arrangement

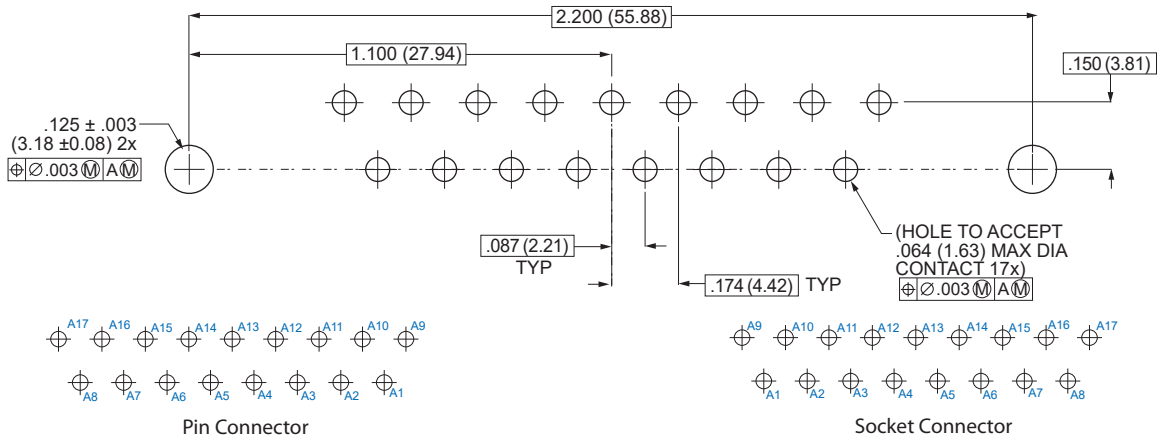

M-4P4 Arrangement

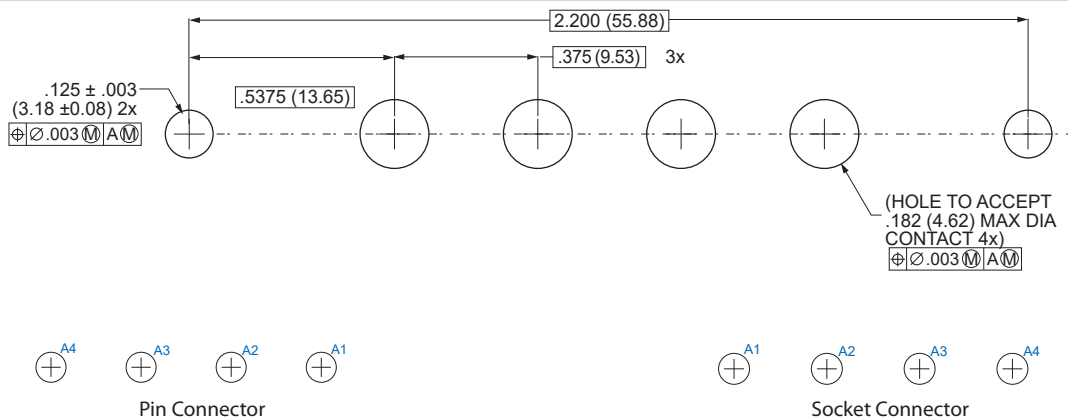



HIGH-SPEED

Series 792

The Next-Generation Ultraminiature Rectangular Connector for High Speed Aerospace Applications

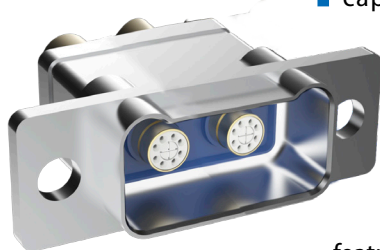
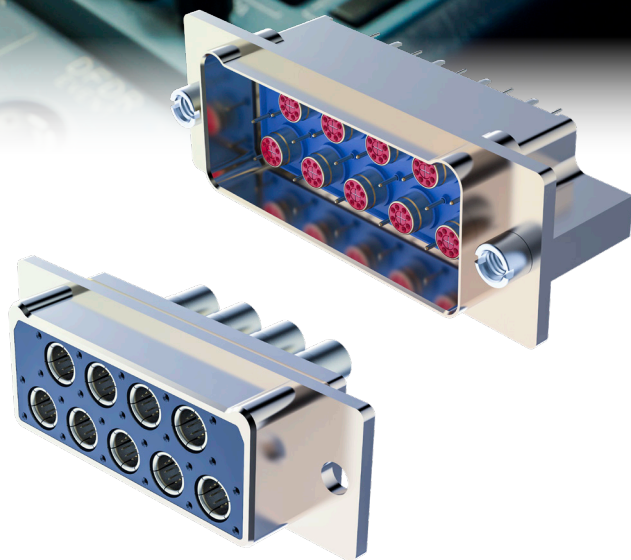

The Series 792 connector brings high speed data capability to the Glenair Series 79 rectangular connector family. Size 8 cavities accept standard quadrax and El Ochoito datalink contacts. The 792's small size and blind mate capability makes it a perfect choice for radars, weapons systems, communications gear, satellites, exoatmospheric vehicles, avionics, and instrumentation. Board mount versions feature straight and right angle terminals.

The Series 792 is an aerospace-grade ultraminiature rectangular connector for high speed datalinks. The Series 792 features machined aluminum alloy shells with dual lobes for polarization. The 100% scoop-proof interface protects contacts from damage. An optional ground spring reduces susceptibility to EMI problems. Board mount versions include straight or right angle terminals.

- Ethernet, USB 3.0, HDMI
- Printed circuit board and cable
- Scoop-proof interface
- 12 arrangements, 6 shell sizes for the ultimate in versatility
- Rugged aluminum alloy dual lobe shell
- Environmental
- EMI protection
- Blind mating



**MISSION-CRITICAL
INTERCONNECT
SOLUTIONS**

Glenair, Inc.

1211 Air Way • Glendale, California • 91201-2497

Telephone: 818-247-6000 • Fax: 818-500-9912 • sales@glenair.com

www.glenair.com

**Glenair Power
Products Group**

20 Sterling Drive
Wallingford, CT
06492

Telephone:
203-741-1115
Facsimile:
203-741-0053
sales@glenair.com

Glenair UK Ltd

40 Lower Oakham Way
Oakham Business Park
Mansfield, Notts
NG18 5BY England

Telephone:
+44-1623-638100
Facsimile:
+44-1623-638111
sales@glenair.co.uk

Glenair Microway Systems

7000 North Lawndale Avenue
Lincolnwood, IL
60712

Telephone:
847-679-8833
Facsimile:
847-679-8849

Glenair Nordic AB

Gustav III : S Boulevard 46
SE-169 27 Solna
Sweden

Telephone:
+46-8-50550000
sales@glenair.se

Glenair Electric GmbH

Schaberweg 28
61348 Bad Homburg
Germany

Telephone:
06172 / 68 16 0
Facsimile:
06172 / 68 16 90
info@glenair.de

Glenair Iberica

C/ La Vega, 16
45612 Velada
Spain

Telephone:
+34-925-89-29-88
Facsimile:
+34-925-89-29-87
sales@glenair.es

Glenair Italia S.p.A.

Via Del Lavoro, 7
40057 Quarto Inferiore –
Granarolo dell'Emilia
Bologna, Italy

Telephone:
+39-051-782811
Facsimile:
+39-051-782259
info@glenair.it

Glenair France SARL

7, Avenue Parmentier
Immeuble Central Parc #2
31200 Toulouse
France

Telephone:
+33-5-34-40-97-40
Facsimile:
+33-5-61-47-86-10
sales@glenair.fr

Glenair Korea

B-1304 Gunpo IT Valley
148 Gosan-Ro, Gunpo-Si
Kyunggi-Do, Korea
435-733

Telephone:
+82-31-8068-1090
Facsimile:
+82-31-8068-1092
sales@glenair.kr

