

SuperNine® RJ45 CAT 5e

MIL-DTL-38999 Series III Type connectors

233-301 Receptacle with crimp removable contacts



RJ45 CAT 5E AND 6A CONNECTORS



Part Number Development									
Sample Part Number	233-301	NF	00	G	17	5H	N	1	T
Basic Number	233-301								
Finish	See Material and Finish table								
Connector Style	See Connector Style table								
Insert-to-Shell Grounding	- = Inline shielded RJ45 insert G = Shielded and grounded to shell ²								
Shell Size	17 or 19								
RJ45 Category	5H = CAT 5e For Cat 6A applications consult factory								
Alternate Key Position¹	Per MIL-DTL-38999 A, B, C, D, E, N = Normal								
RJ45 Orientation	1, 2, 3, or 4								
Shrink Boot	T = Part No. 770-028 (Omit for None)								

Connector Style ¹	
00	Wall mount receptacle with slotted holes
05	Inline Receptacle
07	rear panel mount, jam nut receptacle
D0	Wall mount receptacle with round holes
CM	Wall mount receptacle with metric clinch nuts
CS	Wall mount receptacle with metric clinch nuts
G6	plug

Material and Finish	
NF	Aluminum/Cadmium, Olive Drab
ME	Aluminum/Electroless Nickel
MT	Aluminum/Nickel PTFE
ZR	Aluminum/Black Zinc-Nickel

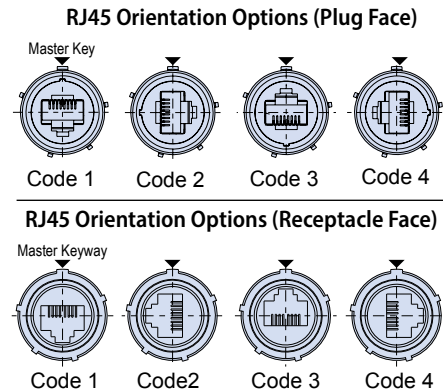

NOTES

- See Section A for alternate key/keyway positions and panel cutout dimensions
- G option is inline shielded and grounded to shell, available for receptacle only
- Front panel mount only
- Crimp removable size 22 pin contacts (M39029/58-360) supplied loose
- Meets IP67 in unmated condition and IP68 mated condition
- For shrink boot see part number 770-028
- Receptacle connector has RJ45 jack

All external dimensions, features, etc. compliant with D38999/20, /24, &/26. Consult factory for additional information.

G6 PLUG WITH ACCESSORY THREADS

Plug Dimensions				
Shell Size	A Dia Max		B Dia	
	in	mm	in	mm
17	1.406	35.71	.928 .922	23.57 23.42
19	1.516	38.51	1.033 1.027	26.24 26.09

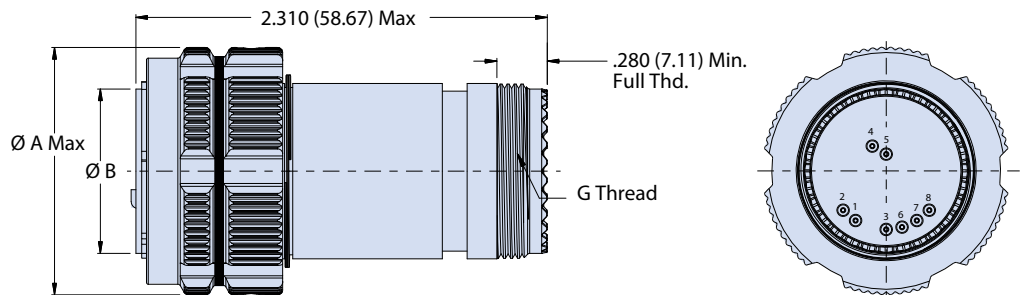

05 - INLINE AND 07 - REAR PANEL MOUNT, JAM NUT RECEPTACLE WITH ACCESSORY THREADS

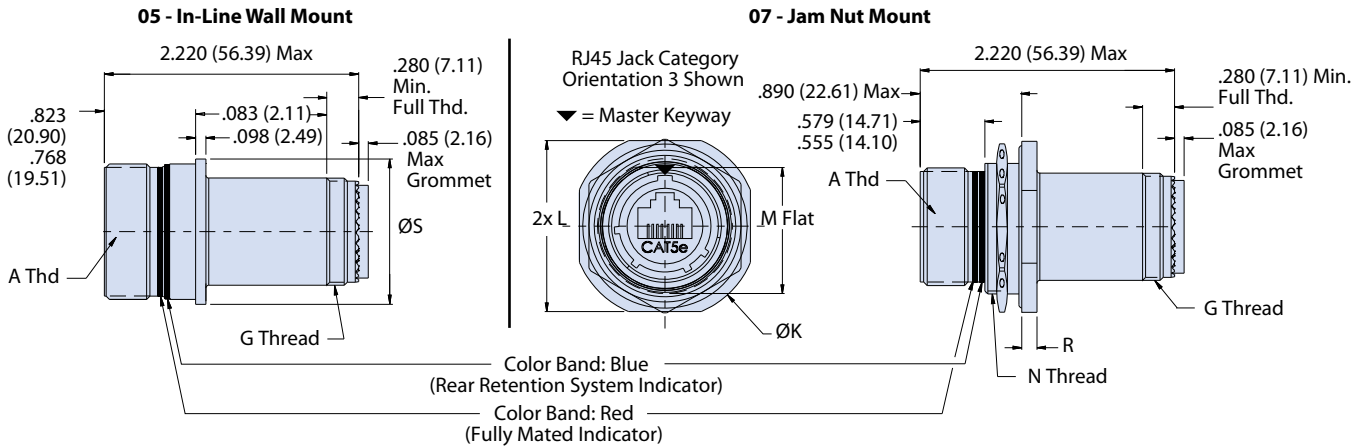

00, D0 AND CM - WALL MOUNT RECEPTACLES WITH ACCESSORY THREADS

00 - Wall Mount Receptacle with Slotted Holes (Mating Face)

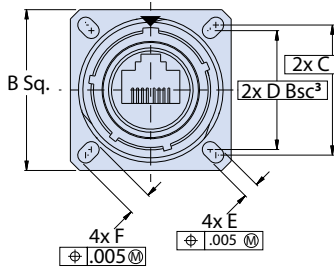

D0 - Wall Mount Receptacle with Round Holes (Mating Face)

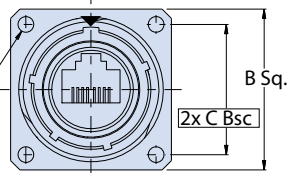

CM - Wall Mount Receptacle with Metric Clinch Nuts (Mating Face)

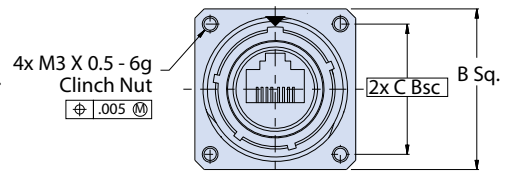

00, D0 and CM - Wall Mount Receptacle

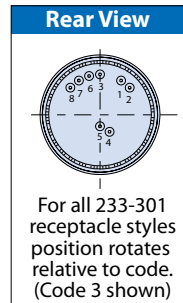
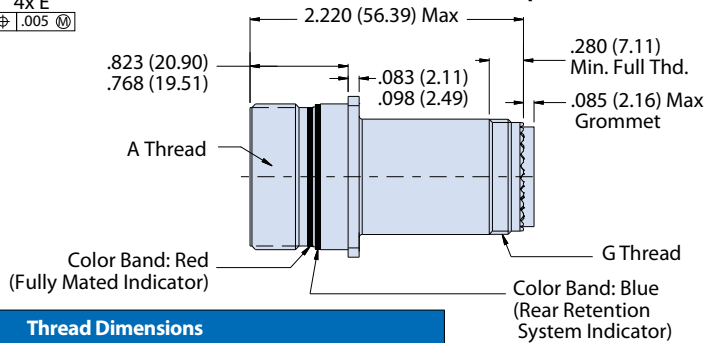

Thread Dimensions			
Shell Size	A Thread	G Thread	N Thread
17	1.1875-.1P-.3L-TS-2A	M25 x 1.0-6g 0.100R	M32 x 1.0-6g 0.100R
19	1.2500-.1P-.3L-TS-2A	M28x 1.0-6g 0.100R	M35 x 1.0-6g 0.100R

In-line and Jam Nut Receptacle Dimensions					
Shell Size	ØK	L	M	R	ØS
17	1.764 (44.81)	1.642 (41.71)	1.191 ()	.122 (3.09)	1.275 (32.39)
	1.740 (44.20)	1.610 (40.89)	1.181 ()	.083 (2.11)	
19	1.949 (49.50)	1.827 (46.51)	1.316 ()	.153 (3.89)	1.337 (33.96)
	1.925 (48.90)	1.795 (45.59)	1.305 ()	.114 (2.90)	

Wall Mount Receptacle Dimensions						
Shell Size	B Sq	C Bsc	D Bsc³	E	F	Ø H Holes
17	1.323 (33.60)	1.062 (26.97)	.969 (24.61)	.136 (3.45)	.202 (5.13)	.136 (3.45)
	1.299 (32.99)					
19	1.449 (36.80)	1.156 (29.36)	1.062 (26.97)	.120 (3.05)	.186 (4.72)	.120 (3.05)
	1.425 (36.20)					