



IAW MIL-DTL-5015

## Appendix



For Super ITS-MB, Super ITS-IGE-MB and Super-ITS-RG Connectors

### *Super ITS-MB / IGE -MB / ITS-RG*

<b>Standard Insert Arrangements</b>	Page D-2
<b>Thermocouple Insert Arrangements</b>	Page D-7
<b>Standard Contact Layouts</b>	Page D-9
<b>Insert Rotation Alternate Positions</b>	Page D-31
<b>Panel Cutout Dimensions and Max Panel Thickness</b>	Page D-33
<b>Super ITS-MB and Super ITS-RG Contact Performance Ratings</b>	Page D-34
<b>Super ITS-MB and Super ITS-RG Pin Crimp Contacts and Crimp Tools</b>	Page D-35
<b>Super ITS-MB and Super ITS-RG Socket Crimp Contacts and Crimp Tools</b>	Page D-37
<b>Super ITS-MB and Super ITS-RG Pin Contact Insertion and Removal Tools</b>	Page D-39
<b>Super ITS-MB and Super ITS-RG Socket Contact Insertion and Removal Tools</b>	Page D-41
<b>Super ITS-MB and Super ITS-RG Pin Crimp Contact Dimensions</b>	Page D-43
<b>Super ITS-MB and Super ITS-RG Socket Crimp Contact Dimensions</b>	Page D-45
<b>Super ITS-MB and Super ITS-RG LouverBand™ Socket Contact</b>	Page D-47
<b>Super ITS-MB and Super ITS-RG Contact Reducers</b>	Page D-48
<b>Super ITS-MB and Super ITS-RG Coaxial Pin and Socket Contacts</b>	Page D-49
<b>Super ITS-MB and Super ITS-RG Coaxial Contact Assembly Procedures</b>	Page D-50
<b>Super ITS-MB, Super ITS-RG, and Super IGE-MB Plug Covers</b>	Page D-51
<b>Super ITS-MB, Super ITS-RG, and Super IGE-MB Wall Mount Receptacle Cover</b>	Page D-52
<b>Super ITS-MB, Super ITS-RG, and Super IGE-MB Jam-Nut Receptacle Cover</b>	Page D-53
<b>Super ITS-MB, Super ITS-RG and Super IGE-MB Front and Rear Panel Mount Dummy Stowage Receptacles</b>	Page D-54
<b>Super ITS-MB Super IGE-MB Cable Clamps and Neoprene Sleeves</b>	Page D-55
<b>Super ITS-MB, Super ITS-RG, and Super IGE-MB and Wall Mount Gaskets</b>	Page D-56
<b>Super ITS-MB and Super ITS-RG Wire Sealing Plugs</b>	Page D-57



# IAW MIL-DTL-5015 Standard Insert Arrangements



For Seacrow (ITS-MB and IGE-MB), Radgrip (ITS-RG),  
and Nuclear-Grade (ITS-NG) Connectors

SUPER ITS: APPENDIX - INSERT ARRANGEMENTS / ACCESSORIES

Contact			Contact Size							
Layout	Rating	Qty	4/0	0	4	8	12	16	18	20
10SL-3	A	3						3		
10SL-4	A	2						2		
14S-1	A	3						3		
14S-2	I	4						4		
14S-5	I	5						5		
14S-6	I	6						6		
14S-7	A	3						3		
14S-9	A	2						2		
14S-07	I	7						7		
16S-1	A	7						7		
16S-4	D	2						2		
16S-5	A	3						3		
16S-8	A	5						5		
16-2	E	1					1			
16-7	A	3				1		2		
16-9	A	4					2	2		
16-10	A	3					3			
16-11	A	2					2			
16-12	A	1			1					
16-A10*	I	10							10	
18-1**	--	10						10		
18-3	D	2					2			
18-4	D	4						4		
18-5	D	3					2	1		
18-6	D	1			1					
18-06	A	6					4	2		
18-7	B	1				1				
18-8	A	8					1	7		
18-9	I	7					2	5		
18-10	A	4					4			
18-10S MT	A	4					4			
18-11	A	5					5			
18-12	A	6						6		
18-13	A	4				1	3			
18-16	C	1					1			
18-19	A	10						10		
18-20	A	5						5		
18-22	D	3						3		
18-30 (18-20x110°)	A	5						5		
20-2	D	1		1						
20-3	D	3					3			
20-4	D	4					4			
20-6	D	3						3		
20-7**	--	8						8		
20-8	I	6				2		4		

Contact			Contact Size							
Layout	Rating	Qty	4/0	0	4	8	12	16	18	20
20-9**	--	8					1	7		
20-11	I	13						13		
20-14	A	5				2	3			
20-15	A	7					7			
20-16	A	9					2	7		
20-17	A	6					5	1		
20-18	A	9					3	6		
20-19	A	3				3				
20-21	A	9					1	8		
20-22	A	6				3		3		
20-23	A	2				2				
20-24	A	4				2		2		
20-A24	A	4				2		2		
20-25 (20-11x100°)	I	13						13		
20-27	A	14						14		
20-29	A	17						17		
20-30 (20-11x250°)	I	13						13		
20-33	A	11						11		
20-A8	I	8				2		6		
20-A9**	--	9					9			
20-A48	I	19						19		
20-B8	A	8					4	4		
22-1	D	2				2				
22-2	D	3				3				
22-4	A	4				2	2			
22-5	D	6					2	4		
22-7	E	1		1						
22-9	E	3					3			
22-10	E	4						4		
22-11	B	2						2		
22-12	D	5				2		3		
22-14	A	19						19		
22-15**	--	6					5	1		
22-17**	--	9					1	8		
22-18**	--	8						8		
22-19	A	14						14		
22-20	A	9						9		
22-21	A	3		1				2		
22-22	A	4				4				
22-23**	--	8					8			
22-27**	--	9				1		8		
22-28	A	7					7			
22-34	D	5					3	2		

\* Only crimp contact version

\*\* Multiple contact sizes; see insert arrangement layouts in this section



IAW MIL-DTL-5015  
STANDARD INSERT ARRANGEMENTS



For Seacrow (ITS-MB and IGE-MB), Radgrip (ITS-RG),  
and Nuclear-Grade (ITS-NG) Connectors

Contact			Contact Size							
Layout	Rating	Qty	4/0	0	4	8	12	16	18	20
22-82	A	10				2		8		
22-A10	A	10						10		
22-A37*	A	37							37	
22-22S MT	A	4				4				
24-2	D	7					7			
24-3	A	7					2	5		
24-4	D	4		1				3		
24-5	A	16						16		
24-06	D	6				4		2		
24-6**	--	8					8			
24-07	D	7					7			
24-7	A	16					2	14		
24-9	A	2			2					
24-10	A	7				7				
24-11	A	9				3	6			
24-12	A	5			2		3			
24-013	A	13					6	7		
24-19	A	12						12		
24-20	D	11					2	9		
24-22	D	4				4				
24-27	E	7						7		
24-28	I	24						24		
24-67	A	19					19			
24-A1	B	1		1						
24-A8	A	8				5	3			
24-A11	A	11				2		9		
24-A12	A	12			2			10		
24-A25	A	25						25		
24-A28	I	28						28		
24-A55*	I	55								55
24-G5	A	5				5				
28-1**	--	9				3	6			
28-2	D	14					2	12		
28-3	E	3				3				
28-6	D	3			3					
28-09	A	9			4			5		
28-9	D	12					6	6		
28-10**	--	7			2	2	3			
28-11	A	22					4	18		
28-12	A	26						26		
28-13 (28-12x100°)	A	26						26		
28-15	A	35						35		
28-16	A	20						20		
28-17**	--	15						15		
28-18**	--	12						12		

Contact			Contact Size							
Layout	Rating	Qty	4/0	0	4	8	12	16	18	20
28-19**	--	10					4	6		
28-20	A	14					10	4		
28-21	A	37						37		
28-22	D	6				3		3		
28-51	D	12					12			
28-59	A	17					7	10		
28-70	A	7				7				
28-72*	I	72								72
28-84	A	9				9				
28-124	A	16				4		12		
28-A29	A	29				2		27		
28-A31*	A	31				6				25
28-A35	A	35						35		
28-A63	I	28					9	19		
28-B1	B	1		1						
28-B2	E	2				2				
32-1**	--	5		2			3			
32-2	E	5				3		2		
32-3	D	9		1	2		2	4		
32-5	D	2		2						
32-6	A	23			2	3	2	16		
32-7**	--	35					7	28		
32-8	A	30					6	24		
32-9	D	14			2			12		
32-013	D	13					13			
32-13	D	23					5	18		
32-15	D	8		2			6			
32-17	D	4			4					
32-22	A	54						54		
32-31	A	31						31		
32-59	A	42				2		40		
32-68	A	16			4			12		
32-689	A	9			3			6		
32-A5GM	A	5			5					
32-76	A	19					19			
32-79	D	5			4	1				
32-88	A	54						54		
32-A1	A	1	1							
32-A3	E	3			3					
32-A8	A	8				8				
32-A25	A	25					25			
32-A27	A	27					10	17		
32-A28	A	28					28			
32-A30	A	30					10	20		
32-A40	A	40						40		

\* Only crimp contact version

\*\* Multiple contact sizes; see insert arrangement layouts in this section



# I AW MIL-DTL-5015 Standard Insert Arrangements



For Seacrow (ITS-MB and IGE-MB), Radgrip (ITS-RG),  
and Nuclear-Grade (ITS-NG) Connectors

SUPER ITS: APPENDIX - INSERT ARRANGEMENTS / ACCESSORIES

Contact			Contact Size							
Layout	Rating	Qty	4/0	0	4	8	12	16	18	20
32-A48	I	48						48		
32-A55	A	55						55		
32-B22	A	22			2			20		
36-01	C	1	1							
36-3	D	6		3			3			
36-4**	--	3		3						
36-5	A	4		4						
36-6	A	6		2	4					
36-7	A	47				7	40			
36-8	A	47				1	46			
36-9	A	31		1	2	14	14			
36-10	A	48					48			
36-14	D	16			5	5	6			
36-15**	--	35					35			
36-18 (36-9x100*)	A	31		1	2	14	14			
36-22	D	22				22				
36-35	A	36			4		32			
36-54 = 36-B39	A	39			8		31			
36-66	A	56				4	52			
36-74	A	44			1		43			
36-77	D	7		7						
36-A7	A	7	3	2		2				
36-A10	A	10		2	8					
36-A35	A	8	4				4			
36-A51	D	6	3	2			1			
36-A72*	I	72				4	16	52		
36-A99*	A	65					15		50	
36-B61	E	6		2			4			
36-B78	D	14			12		2			
36-B90	D	1	n.1 Special Contact							
36-D78	D	14			10		4			
40-1	D	30				6	24			
40-9	A	47			1	22	24			
40-10	A	29		4	9		16			
40-26	A	26			7	19				
40-31	D	31				31				
40-35	D	35				35				
40-47	A	47			1	22	24			
40-53	A	60					60			
40-56	A	85					85			
40-62	A	60					60			
40-63	A	61					61			
40-67	A	11		10			1			
40-100*	A	100						100		
40-150*	I	150						150		

Contact			Contact Size							
Layout	Rating	Qty	4/0	0	4	8	12	16	18	20
40-951	A	51					25	26		
40-A3	A	5	3				2			
40-A4	A	6	4				2			
40-A5	A	5	3	1			1			
40-A5GM	A	5	5							
40-A6	B	6					6			
40-A8	E	8	4					4		
40-A9	A	9	3			6				
40-A10	D	8		4				4		
40-A14	A	14		8			6			
40-A20	D	20				2	18			
40-A24	D	24				8	16			
40-A38	A	38					38			
40-A51	A	31				15		16		
40-A55	A	5	5							
40-A56	A	85						85		
40-A62	A	62				2		60		
40-A65	A	65						65		
40-A70	A	70						70		
40-B4	E	4	4							
40-B19	A	19				19				
40-B25	A	29	4					25		
40-B37	A	37					37			
40-D4	C	4				4				
40-G4	E	4				4				

\* Only crimp contact version

\*\* Multiple contact sizes; see insert arrangement layouts in this section



# IAW MIL-DTL-5015 Standard Insert Arrangements



For Seacrow (ITS-MB and IGE-MB), Radgrip (ITS-RG),  
and Nuclear-Grade (ITS-NG) Connectors

Layout	Number of Contacts		Standard Insert	Alternate Position	Contact Material
	#16	#12			
10SL-51	2	—	10SL-4	45	A=Fe; B=Con
10SL-52	2	—	10SL-4	45	A=Cu; B=Con
10SL-53	2	—	10SL-4	45	A=Al; B=Ch
10SL-54	3	—	10SL-3	—	A=Fe; B=Con; C=Cu
10SL-55	3	—	10SL-3	—	A=Al; B=Ch; C=Cu
10SL-56	2	—	10SL-4	—	A=Al; B=Ch
10SL-57	2	—	10SL-4	—	A=Con; B=Ch
12S-51	2	—	12S-3	315	A=Ch; B=Al
12S-54	2	—	12S-3	315	A=Fe; B=Con
12S-55	2	—	12S-3	45	A=Cu; B=Con
12S-56	2	—	12S-3	—	A=Al; B=Ch
12S-57	2	—	12S-3	60	A=Ch; B=Al
12S-58	2	—	12S-3	120	A=Fe; B=Con
12S-59	2	—	12S-3	—	A=Fe; B=Con
12S-62	2	—	12S-3	—	A=Ch; B=Al
14S-51	2	—	14S-9	90	A=Al; B=Ch
14S-52	4	—	14S-2	45	A, B=Cu; C=Al; D=Ch
14S-53	2	—	14S-9	90	A=Fe; B=Con
14S-54	6	—	14S-6	45	A, C, E=Fe; B, D, F=Con
14S-55	4	—	14S-2	45	A, C=Fe; B, D=Con
14S-56	4	—	14S-2	45	A=Fe; B=Con; C, D=Cu
14S-57	4	—	14S-2	45	A, C=Al; B, D=Ch
14S-58	3	—	14S-4	45	A=Al; B=Ch; C=Cu
14S-59	2	—	14S-9	90	A=Cu; B=Con
14S-60	2	—	14S-9	—	A=Al; B=Ch
14S-61	6	—	14S-6	45	A=Al; B=Ch; C=Fe; D=Con; E, F=Cu
14S-63	6	—	14S-6	—	A, C=Al; B, D=Ch; E=Fe; F=Con
14S-64	4	—	14S-2	—	A, C=Con; B, D=Cu
14S-65	6	—	14S-6	—	A, C, E=Cu; B, D, F=Con
14S-67	6	—	14S-6	—	A=Al; B=Ch; Bal=Cu
14S-68	4	—	14S-2	45	A=Ch; B=Con; C, D=Cu
14S-69	3	—	14S-7	—	A=Con; B=Ch; C=Cu
14S-70	4	—	14S-2	—	A=Ch; D=Al; Bal=Cu
14S-71	4	—	14S-2	—	n°2=Ch; n°2=Con
14S-72	4	—	14S-2	—	A, C=Fe; B, D=Con
14S-73	4	—	14S-2	—	A, C=Ch; B, D=Al
14S-74	4	—	14S-2	—	A=Al; B=Ch; Bal=Cu
14S-77	6	—	14S-6	—	A, B, C=Al; D, E, F=Ch
14S-78	4	—	14S-2	—	A, B=Al; C, D=Ch
14S-79	5	—	14S-5	—	n°1=Al; n°1=Ch, Bal=Cu
14S-80	3	—	14S-7	—	n°2=Fe; n°1=Con
16S-50	5	—	16S-8	—	n°1=Con; n°1=Fe, n°3=Cu

Layout	Number of Contacts		Standard Insert	Alternate Position	Contact Material
	#16	#12			
16S-51	7	—	16S-1	—	A, F=Al; B=Ch; Bal=Cu
16S-52	2	—	16S-4	—	A=Ch; B=Al
16S-53	3	—	16S-5	—	A, B, C=Fe
16S-54	7	—	16S-1	—	A=Al; B=Ch; Bal=Cu
10SL-51	2	—	10SL-4	45	A=Fe; B=Con
10SL-52	2	—	10SL-4	45	A=Cu; B=Con
10SL-53	2	—	10SL-4	45	A=Al, B=Ch
10SL-54	3	—	10SL-3	—	A=Fe; B=Con, C=Cu
10SL-55	3	—	10SL-3	—	A=Al; B=Ch, C=Cu
10SL-56	2	—	10SL-4	—	A=Al; B=Ch
10SL-57	2	—	10SL-4	—	A=Con; B=Ch
12S-51	2	—	12S-3	315	A=Ch; B=Al
12S-54	2	—	12S-3	315	A=Fe; B=Con
12S-55	2	—	12S-3	45	A=Cu; B=Con
12S-56	2	—	12S-3	—	A=Al; B=Ch
12S-57	2	—	12S-3	60	A=Ch; B=Al
12S-58	2	—	12S-3	120	A=Fe; B=Con
12S-59	2	—	12S-3	—	A=Fe; B=Con
12S-62	2	—	12S-3	—	A=Ch; B=Al
14S-51	2	—	14S-9	90	A=Al; B=Ch
14S-52	4	—	14S-2	45	A, B=Cu; C=Al, D=Ch
14S-53	2	—	14S-9	90	A=Fe; B=Con
14S-54	6	—	14S-6	45	A, C, E=Fe; B, D, F=Con
14S-55	4	—	14S-2	45	A, C=Fe; B, D=Con
14S-56	4	—	14S-2	45	A=Fe; B=Con; C, D=Cu
14S-57	4	—	14S-2	45	A, C=Al; B, D=Ch
14S-58	3	—	14S-4	45	A=Al; B=Ch; C=Cu
14S-59	2	—	14S-9	90	A=Cu; B=Con
14S-60	2	—	14S-9	—	A=Al; B=Ch
14S-61	6	—	14S-6	45	A=Al; B=Ch; C=Fe; D=Con; E, F=Cu
14S-63	6	—	14S-6	—	A, C=Al; B, D=Ch; E=Fe; F=Con
14S-64	4	—	14S-2	—	A, C=Con; B, D=Cu
14S-65	6	—	14S-6	—	A, C, E=Cu; B, D, F=Con
14S-67	6	—	14S-6	—	A=Al; B=Ch; Bal=Cu
14S-68	4	—	14S-2	45	A=Ch; B=Con; C, D=Cu
14S-69	3	—	14S-7	—	A=Con; B=Ch; C=Cu
14S-70	4	—	14S-2	—	A=Ch; D=Al; Bal=Cu
14S-71	4	—	14S-2	—	n°2=Ch; n°2=Con
14S-72	4	—	14S-2	—	A, C=Fe; B, D=Con
14S-73	4	—	14S-2	—	A, C=Ch; B, D=Al
14S-74	4	—	14S-2	—	A=Al; B=Ch; Bal=Cu
14S-77	6	—	14S-6	—	A, B, C=Al; D, E, F=Ch
14S-78	4	—	14S-2	—	A, B=Al; C, D=Ch
14S-79	5	—	14S-5	—	n°1=Al; n°1=Ch, Bal=Cu
14S-80	3	—	14S-7	—	n°2=Fe; n°1=Con
16S-50	5	—	16S-8	—	n°1=Con; n°1=Fe, n°3=Cu

SUPER ITS: APPENDIX - INSERT ARRANGEMENTS / ACCESSORIES





# IAW MIL-DTL-5015 Standard Insert Arrangements



For Seacrow (ITS-MB and IGE-MB), Radgrip (ITS-RG),  
and Nuclear-Grade (ITS-NG) Connectors

SUPER ITS: APPENDIX - INSERT ARRANGEMENTS / ACCESSORIES

D

Layout	Number of Contacts		Standard Insert	Alternate Position	Contact Material
	#16	#12			
14S-79	5	—	14S-5	—	n°1=Al; n°1=Ch; Bal=Cu
14S-80	3	—	14S-7	—	n°2=Fe; n°1=Con
16S-50	5	—	16S-8	—	n°1=Con; n°1=Fe; n°3=Cu
16S-51	7	—	16S-1	—	A, F=Al; B=Ch; Bal=Cu
16S-52	2	—	16S-4	—	A=Ch; B=Al
16S-53	3	—	16S-5	—	A, B, C=Fe
16S-54	7	—	16S-1	—	A=Al; B=Ch; Bal=Cu
16S-55	2	—	16S-4	—	n°1=Con; n°1=Cu
16S-56	7	—	16S-1	—	A, D=Fe; B, E=Con; Bal=Cu
16S-57	3	—	16S-5	—	n°1=Ch; n°1=Al; n°1=Cu
16S-58	5	—	16S-8	—	n°2=Fe; n°2=Con; n°1=Cu
16S-59	7	—	16S-1	—	n°3=Al; n°3=Ch; n°1=Cu
16-13	2	—	16-13	—	A=Fe; B=Con
16-52	2	—	16-11	90	A=Al; B=Ch
16-53	2	2	16-9	70	A=Al; C=Ch; B, D=Cu
16-55	—	3	16-10	45	A=Al; B=Ch; C=Cu
16-56	—	2	16-13	90	A=Con; B=Cu
16-57	—	3	16-10	—	A=Al; B=Cu; C=Ch
16-58	—	3	16-10	—	A=Con; B, C=Cu
16-60	—	2	16-13	—	A=Al; B=Ch
18-15	—	4	18-15	—	A, C=Fe; B, D=Con
18-41	4	—	18-4	—	A, C=Fe; B, D=Con
18-42	4	—	18-4	—	A, C=Al; B, D=Ch
18-43	4	—	18-4	—	A, C=Ch; B, D=Con
18-44	3	—	18-22	—	n°1=Al; n°1=Ch; n°1=Cu
18-45	5	—	18-20	—	A=Fe; B=Con; Bal=Cu
18-46	4	—	18-4	—	n°1=Ch; n°1=Al; n°2=Cu
18-47	4	—	18-4	—	A, C=Ch; B, D=Al
18-49	10	—	18-1	—	n°3=Fe; n°3=Con; Bal=Cu
18-50	—	2	18-3	—	n°1=Al; n°1=Ch
18-51	6	—	18-12	—	A, B=Fe; E, D=Con; C, F=Cu / (A=Fe; B, E=Con; D=Cu; C,F=Dummy)
18-52	—	5	18-11	—	A=Fe; B=Con; C=Ch; D=Al; E=Cu / (A=Fe; B=Con; C=Ch; D=Al; E=Dummy)
18-53	6	—	18-12	—	A, D=Fe; B, E=Con; C, F=Cu / (A, D=Fe; B, E=Con; C, F=Dummy)

Layout	Number of Contacts		Standard Insert	Alternate Position	Contact Material
	#16	#12			
18-54	—	4	18-15	—	A, C=Al; B, D=Ch
18-56	10	—	18-1	45	A, C, E, G, I=Fe; B, D, F, H, J=Con
18-57	6	—	18-12	45	A, C, E=Al; B, D, F=Ch
18-59	6	—	18-12	45	A, C=Fe; B, E, F=Con; D=Cu
18-60	—	5	18-11	45	A, D=Al; B, C=Ch; E=Cu
18-61	6	—	18-12	—	A, C=Fe; B, D=Con; E=Ch; F=Al
18-62	6	—	18-12	—	A, B, C=Fe; D, E, F=Con
18-63	—	4	18-15	—	A, C=Con; B, D=Cu
18-65	6	—	18-12	—	A=Fe; B=Con - Bal=Cu
18-66	10	—	18-1	—	A, C, E, G, I=Cu; B, D, F, H, J=Con
18-67	6	—	18-12	—	A, C, E=Cu; B, D, F=Con
18-68	5	—	18-11	—	A, D=Al; B, C=Ch; E=Cu
18-69	10	—	18-1	—	A=Al; B, C=Ch; Bal=Cu
18-70	—	5	18-11	—	A=Fe; B=Con; C=Ch; D=Al; E=Cu
18-71	6	—	18-12	—	n°2=Al; n°2=Ch; n°2=Cu
18-72	—	4	18-10	45	n°2=Fe; n°2=Con
18-73	—	4	18-10	—	n°2=Fe; n°2=Con
18-74	—	4	18-10	—	n°2=Con; n°2=Cu
18-75	10	—	18-1	—	n°2=Al; n°2=Ch; Bal=Cu
20-222	3	3#8	20-22	-	B=Fe; D=Con; Bal=Cu
20-50	17	-	20-29	-	n°7=Al; n°7=Ch; n°3=Cu
20-51	8	-	20-7	-	A, C, E, G=Ch; B, D, F, H=Al
20-52	-	4	20-4	315	A=Fe; B=Con; C=Ch; D=Al
20-56	-	8	20-7	45	A, B, G, H=Fe; C, D, E, F=Con
20-60	8	-	20-7	45	D=Ch; E=Al; Bal=Cu
20-61	17	-	20-29	45	A, B, M=Cu; Bal=Con
20-62	-	7	20-15	80	A, C, E=Al; B, D, F=Ch; G=Cu
20-64	14	-	20-27	-	H=Al; C=Ch; Bal=Cu
20-641	14	-	20-27	-	A, B, C, D, E, F, G=Al; H, I, J, K, L, M, N=Ch
20-65	14	-	20-27	-	A, B, C, D, E, F, G=Fe; H, I, J, K, L, M, N=Con
20-67	7	2	20-16	-	H=Al; I=Ch; Bal=Cu



# IAW MIL-DTL-5015 Thermocouple Insert Arrangements



For Seacrow (ITS-MB and IGE-MB), Radgrip (ITS-RG),  
and Nuclear-Grade (ITS-NG) Connectors

Layout	Number of Contacts		Standard Insert	Alternate Position	Contact Material
	#16	#12			
20-68	8	-	20-7	-	A, B, G, H=Con; C, D, E, F=Cu
20-69	14	-	20-27	-	A, B, C, D, E, F, G=Cu; H, I, J, K, L, M, N=Con
20-70	17	-	20-29	-	A, C, E, G, J, L, N, R, T=Fe; B, D, F, H, K, M, P, S=Con
20-71	17	-	20-29	-	S=A; R=Ch; Bal=Cu
20-74	17	-	20-29	-	A, C, E, G, J, L, N, R=Fe; B, D, F, H, K, M, P, S=Con; T=Cu
20-75	-	7	20-15	-	G=Al; Bal=Ch
20-76	17	-	20-29	-	n°8=Ch; n°8=Al; n°1=Cu
20-78	-	4	20-4	-	A=Fe; B=Con; Bal=Cu
20-80	-	3	20-3	-	A=Al; C=Ch; B=Cu
20-81	8	1	20-21	-	n°4=Al; n°4=Ch; I=Cu
20-82	14	-	20-27	-	n°4=Al; n°10=Cu
20-83	14	-	20-27	-	A, B=Ch; C, D=Al; Bal=Cu
20-84	3	3#8	20-22	-	B=Al; D=Ch; Bal=Cu
20-85	14	-	20-27	-	n°12=Ch; n°1=Al; n°1=Cu
20-86	14	-	20-27	-	n°2=Al; n°12=Ch
22-36	-	8	22-36	-	B, D, F, H=Con; A, C, E, G=Fe
22-57	19	-	22-14	45	A, C, E, G, J, L, N, R=Fe; B, D, F, H, K, M, P, S=Con; T, U, V=Cu
22-60	19	-	22-14	45	U=Al; N=Ch; Bal=Cu
22-62	-	8	22-23	300	A, B, F, G=Al; C, D, E, H=Ch
22-68	14	-	22-19	45	A, C, E, G, J, L, M=Fe; B, D, F, H, K, P, N=Con
22-69	14	-	22-19	45	A, C, E, G, J, L, M=Cu; B, D, F, H, K, P, N=Con
22-71	19	-	22-14	-	V=Al; U=Ch; Bal=Cu
22-72	4	2	20-5	-	B=Al; E=Ch; Bal=Cu
22-73	4	2	20-5	-	E=Al; B=Ch; Bal=Cu
22-74	-	8	22-23	-	A, C, E, G=Fe; B, D, F, H=Con
22-75	-	8	22-23	-	A=Al; B, D, G, H=Cu; C=Ch; E=Fe; F=Con
22-77	14	-	22-19	-	B, D, F, H, J, K, M, P=Cu; A, E, L=Fe; C, G, N=Con
22-78	19	-	22-14	-	A, C, E, G, H, K, M, P, R, T=Con; Bal=Cu
22-79	4	-	22-10	-	A, C=Con; B, D=Cu

Layout	Number of Contacts		Standard Insert	Alternate Position	Contact Material
	#16	#12			
22-81	2	3	22-34	-	E=Fe; D=Con; Bal=Cu
22-82	19	-	22-14	-	A, L, C, E, G, J=Fe; B, M, D, F, H, K=Con; N, U, P, R, S, T=Cu; V=Dummy
22-83	19	-	22-14	-	A, L, C, E, G, J=Al; B, M, D, F, H, K=Con; N, U, P, R, S, T=Cu; V=Dummy
22-85	4	2	22-5	-	n°2=Al; n°2=Ch; Bal=Cu
24-412	12	-	24-19	-	n°6=Cu; n°6=Con
24-56	9	2	24-20	45	E=Al; F=Ch; Bal=Cu
24-57	24	-	24-28	45	A, C, J, V, Y, W, K, E, H, U, S, M=Ch; Bal=Al
24-62	24	-	24-28	-	A, C, E, G=Fe; B, D, F, H=Con; R, T=Ch; S, U=Al; Bal=Cu
24-621	24	-	24-28	-	A, C, E, G, J, L, K, N, S, U, W, Y=Fe; B, D, H, Q, R, M, P, T, V, X, Z=Con
24-622	24	-	24-28	-	A, C, E, G, J, L, K, N, S, U, W, Y=Ch; B, D, F, H, Q, R, M, P, T, V, X, Z=Al
24-63	24	-	24-28	-	A, C, E, G, J, L, K, N, S, U, W, Y=Cu; B, D, F, H, Q, R, M, P, T, V, X, Z=Con
24-64	16	-	24-5	-	A, B, C, D, E, F, G, H=Fe; J, K, L, M, N, P, R, S=Con
24-68	24	-	24-28	-	D=Con; Bal=Cu
24-69	12	-	24-19	-	n°5=Con; n°7=Cu
24-71	16	-	24-5	-	A, B, C, D, E, F, G, H=Al; J, K, L, M, N, P, R, S=Ch
28-201	4	10	28-20	-	A, C, E, G, J, P=Con; Bal=Cu
28-53	18	4	28-11	45	J, L=Al; K, M=Ch
28-58	4	10	28-20	45	A, C, E, G, K, M=Al; B, D, F, H, L, N=Ch; J, P=Cu
28-61	37	-	28-21	45	A, C, Z, m, r, n, a, K, F, H, X, k, h, T, M, N, d=Fe; Bal=Con
28-63	4	10	28-20	315	A, C, E, G, J=Al; B, D, F, H, P=Ch; Bal=Cu
28-64	35	-	28-15	-	A, d=Al; B, j=Ch; C, D, E, F, G, N, P, R, S, H, J, K, L, M, W, X, Y, Z = Con; Bal = Cu

SUPER ITS: APPENDIX - INSERT ARRANGEMENTS / ACCESSORIES





IAW MIL-DTL-5015

# Thermocouple Insert Arrangements



For Seacrow (ITS-MB and IGE-MB), Radgrip (ITS-RG), and Nuclear-Grade (ITS-NG) Connectors

SUPER ITS: APPENDIX - INSERT ARRANGEMENTS / ACCESSORIES

Layout	Number of Contacts		Standard Insert	Alternate Position	Contact Material
	#16	#12			
28-65	26	-	28-12	-	A, C, E, G, J, L, N, R, T, V = Fe; X, Z = Al; B, D, F, H, K, M, P, S, U, W = Con; Y, a = Ch; b, d = Cu
28-66	20	-	28-16	-	n°10=Con; n°10=Cu
28-67	20	-	28-16	-	U=Con; Bal=Cu
28-68	35	-	28-15	45	T=Al; U=Ch; Bal=Cu
28-69	18	4	28-11	-	G=Al; R=Ch; Bal=Cu
28-70	18	4	28-11	-	A=Al; B=Ch; Bal=Cu
28-77	20	-	28-16	-	n°6=Fe; n°6=Con; Bal=Cu
28-78	35	-	28-15	-	A, B=Ch; C, D=Al; Bal=Cu
28-80	20	-	28-16	-	n°10=Fe; n°10=Con
28-81	35	-	28-15	-	n°10=Al; n°10=Ch; Bal=Cu
28-811	35	-	28-15	-	n°17=Ch; n°17=Al; n°1=Dummy
28-82	35	-	28-15	-	n°12=Fe; n°12=Con; Bal=Cu
32-50	34	6	32-8	-	M=Ch; N=Al; Bal=Cu
32-51	24	6	32-8	90	M=Ch; N=Al; Bal=Cu
32-55	24	6	32-8	125	M, N=Ch; O, P=Al; Bal=Cu
32A-401	40	-	32A-40	-	n°13=Al; n°13=Ch; n°14=Cu
36-101	48	-	36-10	-	n°24=Al; n°24=Ch
36-102	48	-	36-10	-	n°24=Ch; n°24=Con
36-53	40	7	36-7	45	U, V, W =Al; X, Y, Z=Ch; Bal=Cu
36-56	48	-	36-10	-	A, C, E, G, L, J, H, P, R, T, V, X, Z, b, d, f, h, k, q, m, n, u, w, y=Con - Bal=Cu
36-57	46	1	36-8	-	W =Al; f=Ch; Bal=Cu
36-58	35	-	36-15	-	H=Al; G=Ch; Bal=Cu
36-61	35	-	36-15	-	A, C, E, J, K, L, M, N, P, R, T, V, f, X, Y, h, j, c = Con; Bal=Cu
36-62	48	-	36-10	-	A, C, E=Al; B, D, F=Ch; Bal=Cu
36-63	48	-	36-10	-	n°16=Al; n°16=Ch; n°16=Cu
36-64	48	-	36-10	-	n°24=Fe; n°24=Con

Layout	Number of Contacts		Standard Insert	Alternate Position	Contact Material
	#16	#12			
40-58	85	-	40-56	-	A, C, E, H, K, M, P, S, U, W, Y, a, c, f, h, j, m, p, r, t, v, x, z, AB, AD, AF, AJ, AL, AN, AP, AS, AU, AW, AY, BA, BC, BE, BH, BK, BM, BP, BS, BU=Fe; Bal=Con
40-59	85	-	40-56	-	B=Ch - C=Con - Bal=Cu



For Super ITS-MB Seacrow, Super ITS-RG Radgrip,  
and Super ITS-NG Nuclear-Grade Connectors

**1 CONTACT**

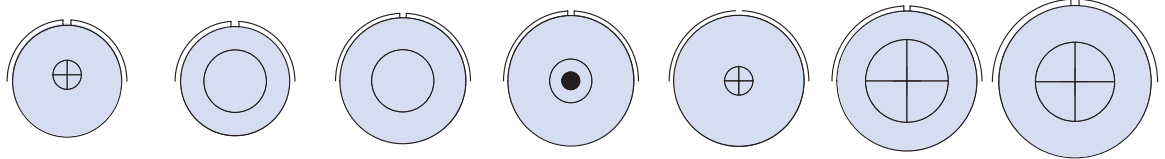

Arrangement	16-2	12-12	18-6	18-7	18-16	20-2	22-7
Contact Size	12	4	4	8	12	0	0
Service Rating	E	A	D	B	C	D	E

**1 CONTACT**

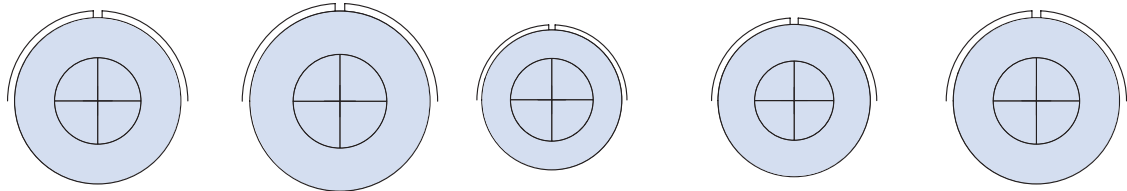

Arrangement	24-A1	28-B1	202	22-7	24-A1
Contact Size	0	0	0	0	0
Service Rating	B	B	D	E	B

**1 CONTACT**

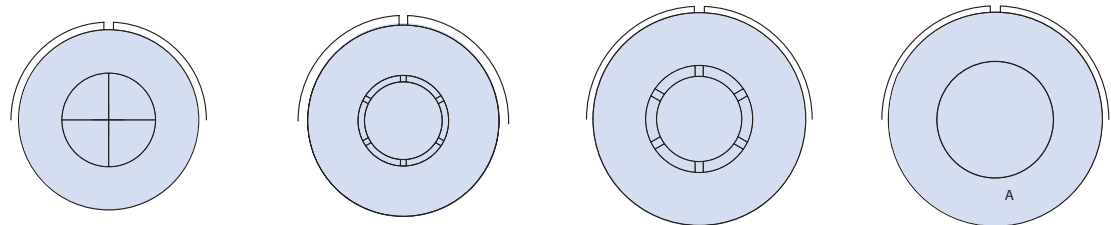

Arrangement	28-B1	32-A1	36-01	36-B90
Contact Size	0	AWG 4/0	AWG 4/0	special
Service Rating	B	A	C	D

**2 CONTACTS**

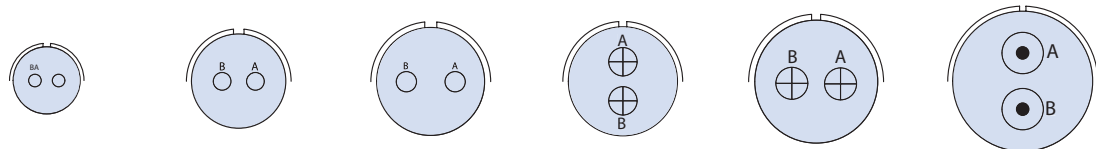

Arrangement	10SL-4	14S-9	16S-4	16-11	18-3	20-23
Contact Size	16	16	16	12	12	8
Service Rating	A	A	D	A	D	A

**CONTACT  
LEGEND**



2 CONTACTS					
Arrangement	22-1	22-11	24-9	28-B2	32-5
Contact Size	8	16	8	8	0
Service Rating	D	B	E	E	D

3 CONTACTS					
Arrangement	10SL-3	145-1	145-7	16S-5	16-7
Contact Size	16	16	16	16	1/8, 2/169
Service Rating	A	A	A	A	A

3 CONTACTS					
Arrangement	16-10	18-5	18-22	20-3	20-6
Contact Size	12	2/12, 1/16	16	12	16
Service Rating	A	D	D	D	D

3 CONTACTS					
Arrangement	20-19	22-2	22-9	22-21	28-3
Contact Size	B	8	12	1/0, 2/16	8
Service Rating	A	DV	E	A	E

CONTACT LEGEND							
	20	18	16	12	80	4	4/0

for Super ITS-MB Seacrow, Super ITS-RG Radgrip,  
and Super ITS-NG Nuclear-Grade Connectors

### 3 CONTACTS

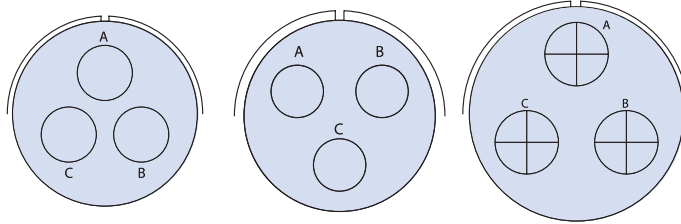

Arrangement	28-6	32-A3	36-4
Contact Size	4	4	0
Service Rating	D	E	A=D; B, C=A

### 4 CONTACTS

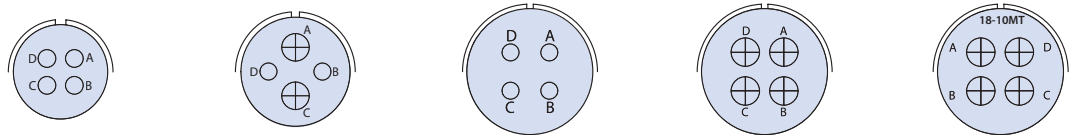

Arrangement	14S-2	16-9	18-4	18-10	18-10S MT*
Contact Size	16	2/12, 2/16	16	12	12
Service Rating	I	A	D	A	A

### 4 CONTACTS

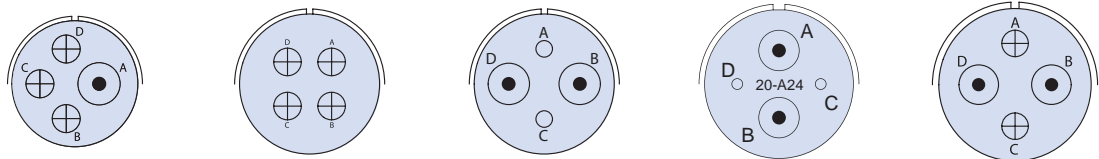

Arrangement	18-13	20-4	20-24	20-A24	22-4
Contact Size	1/8, 3/12	12	2/8, 2/16	2/8, 2/16	2/8, 2/12
Service Rating	A	DS	A	A	A

### 4 CONTACTS

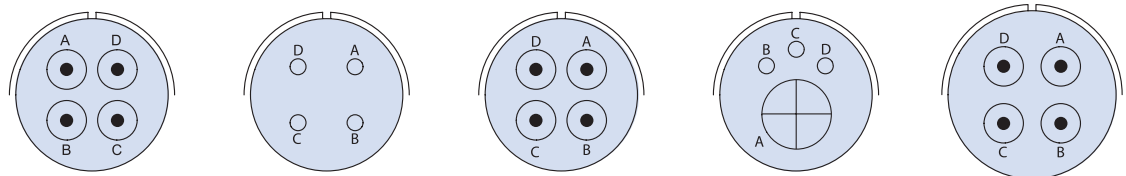

Arrangement	22-22S MT**	22-10	22-22	24-4	24-22
Contact Size	8	16	8	1/0, M 3/16	8
Service Rating	A	E	A	D	D

#### CONTACT LEGEND



### 4 CONTACTS

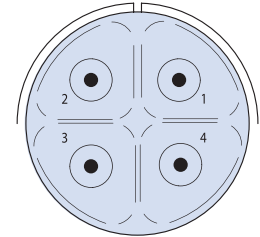
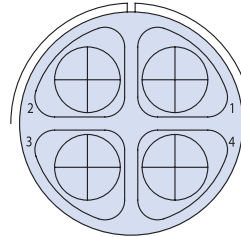
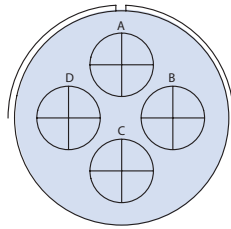
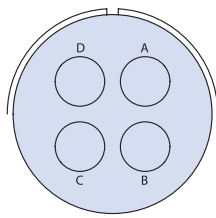

Arrangement	32-17	36-5	40-B4***	40-D4***
Contact Size	4	0	0	8
Service Rating	D	A	E	C

### 4 CONTACTS

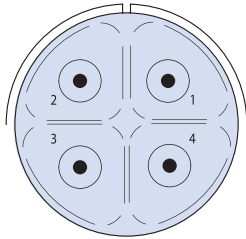

Arrangement	40-G4
Contact Size	8
Service Rating	E

### 5 CONTACTS

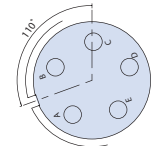
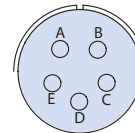
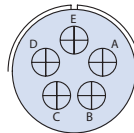
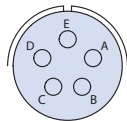
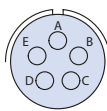

Arrangement	14S-5	16S-8	18-11	18-20	18-30 (18-20 X 110°)
Contact Size	16	16	12	16	16
Service Rating	I	A	A	A	A

### 5 CONTACTS

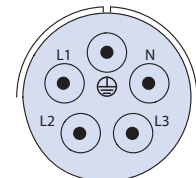
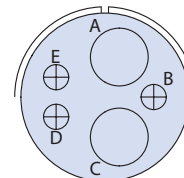
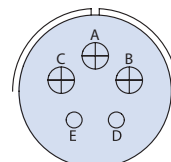
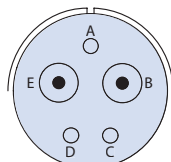
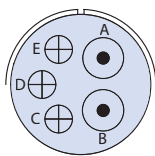

Arrangement	20-14	22-12	22-34	2412	24-G5
Contact Size	2/8, 3/12	2/8, 3/16	3/12, 2/16	2/4, 3/12	8
Service Rating	A	D	D	A	A

<b>CONTACT LEGEND</b>	20	18	16	12	80	4	4/0
-----------------------	----	----	----	----	----	---	-----

for Super ITS-MB Seacrow, Super ITS-RG Radgrip,  
and Super ITS-NG Nuclear-Grade Connectors

**5 CONTACTS**

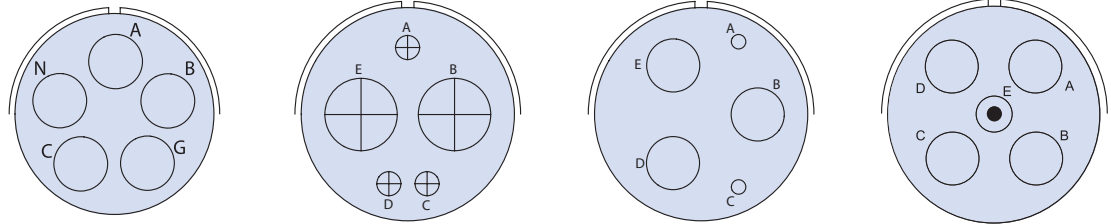

Arrangement	32-A5GM	32-1	32-2	32-79
Contact Size	4	2/0, 3/12	3/4, 2/16	4/4, 1/8
Service Rating	A	A=E; B,C, D, E=D	E	D

**5 CONTACTS**

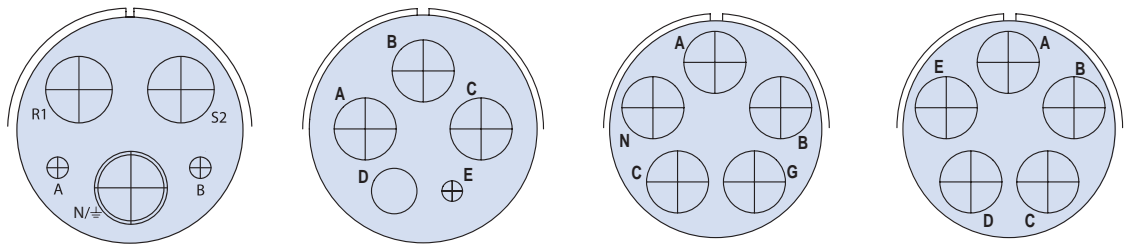

Arrangement	40-A3	40-A5	40-A5 GM	40-A55
Contact Size	1/0M, 2/0, 2/12	3/0, 1/4, 1/12	0	0
Service Rating	A	A	A	A

**5 CONTACTS**

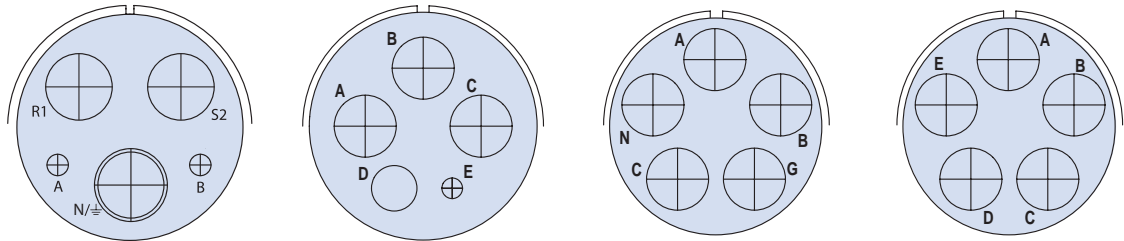

Arrangement	40-A3	40-A5	40-A5 GM	40-A55
Contact Size	1/0M, 2/0, 2/12	3/0, 1/4, 1/12	0	0
Service Rating	A	A	A	A

**CONTACT  
LEGEND**



for Super ITS-MB Seacrow, Super ITS-RG Radgrip,  
and Super ITS-NG Nuclear-Grade Connectors

**6 CONTACTS**



Arrangement	14S-6	18-06	18-12	20-8
Contact Size	16	4/12, 2/16	16	2/8, 4/16
Service Rating	I	A	A	I

**6 CONTACTS**

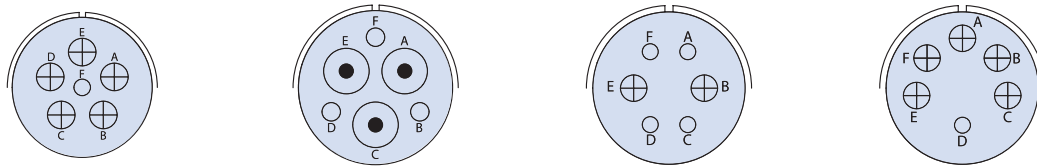

Arrangement	20-17	20-22	22-5	22-15
Contact Size	2/12, 4/16	3/8, 3/16	2/12, 4/16	D=E; A,B,C,E,F=A
Service Rating	D	A	D	

**6 CONTACTS**

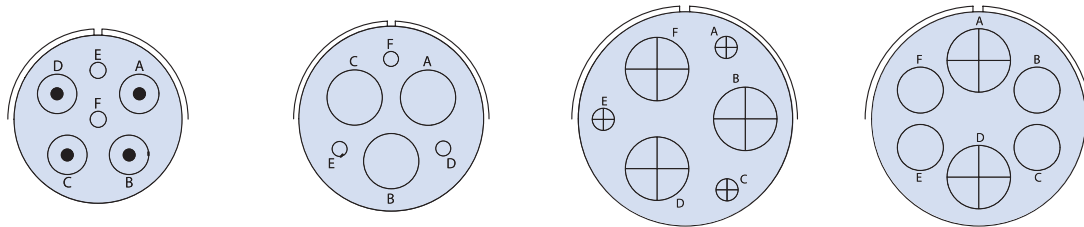

Arrangement	24-06	28-22	36-3	36-6
Contact Size	4/8, 2/16	3/4, 3/16	3/0, 3/12	2/0, 4/4
Service Rating	D	D	D	A

**6 CONTACTS**

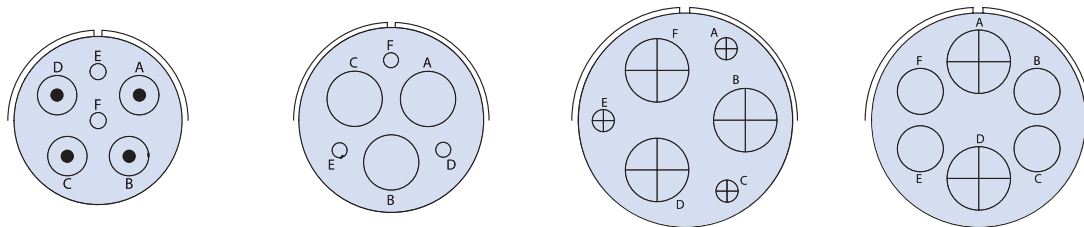

Arrangement	24-06	28-22	36-3	36-6
Contact Size	4/8, 2/16	3/4, 3/16	3/0, 3/12	2/0, 4/4
Service Rating	D	D	D	A

<b>CONTACT LEGEND</b>	20	18	16	12	80	4	4/0
-----------------------	----	----	----	----	----	---	-----

for Super ITS-MB Seacrow, Super ITS-RG Radgrip,  
and Super ITS-NG Nuclear-Grade Connectors

### 6 CONTACTS

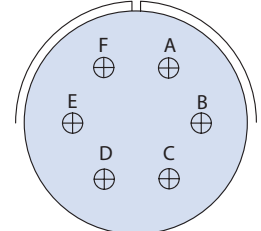
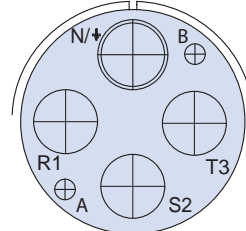
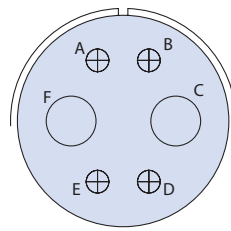
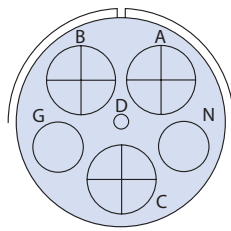

Arrangement	36-A51	36-B61	40-A4	40-A6
Contact Size	3/0, 2/4, 1/16	2/4, 4/12	1/0M, 3/0, 2/12	12
Service Rating	D	E	A	B

### 7 CONTACTS

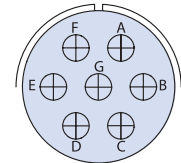
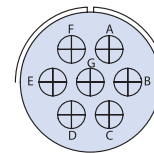
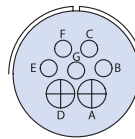
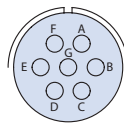
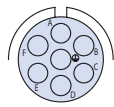

Arrangement	14S-07	16S-1	18-9	20-15	22-28
Contact Size	16	16	2/12, 5/16	12	12
Service Rating	I	A	I	A	A

### 7 CONTACTS

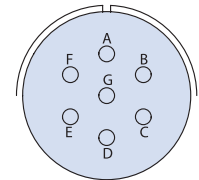
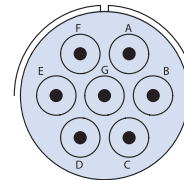
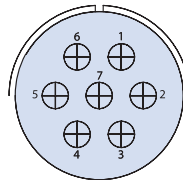
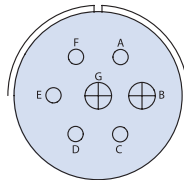
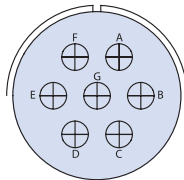

Arrangement	24-2	24-3	24-07	24-10	24-27
Contact Size	12	2/12, 5/16	12	8	16
Service Rating	D	A	D	A	E

#### CONTACT LEGEND



for Super ITS-MB Seacrow, Super ITS-RG Radgrip,  
and Super ITS-NG Nuclear-Grade Connectors

### 7 CONTACTS

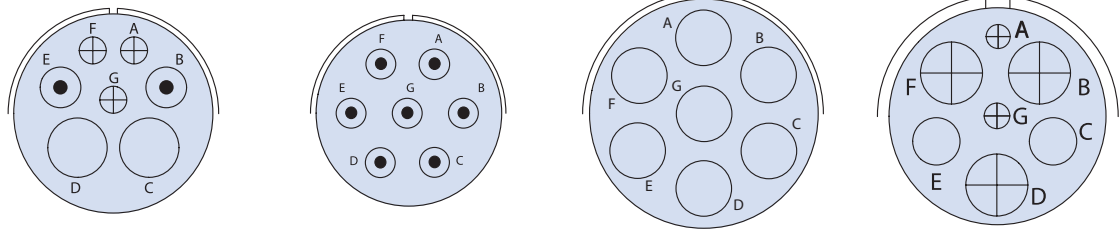

Arrangement	28-10	28-70	36-77	36-A7
Contact Size	2/4, 2/8, 3/	8	4	3/0, 2/4, 2/12
Service Rating	G=D; Bal=A	A	D	A

### 8 CONTACTS

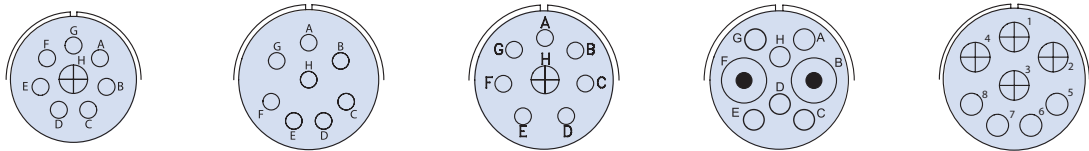

Arrangement	18-8	20-7	20-9	20-A8	20-B8
Contact Size	1/12, 7/16	16	1/12, 7/16	2/8, 6/16	4/12, 4/16
Service Rating	A	A, B, H, G = D; C, D, E, F=A	H=D; Bal=A	I	A

### 8 CONTACTS

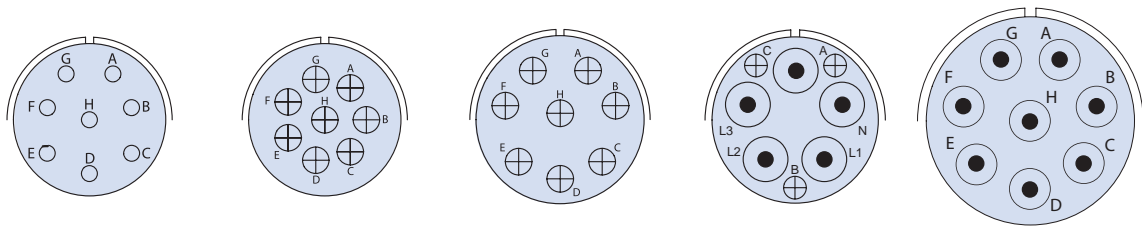

Arrangement	22-18	22-23	24-6	24-A8	32-A8
Contact Size	16	12	12	3/12, 5/8	8
Service Rating	A,B,F,G, H = D; C,D, E=A	H=D; Bal=A	A,G,H=D; Bal=A	A	A

#### CONTACT LEGEND





for Super ITS-MB Seacrow, Super ITS-RG Radgrip,  
and Super ITS-NG Nuclear-Grade Connectors

**9 CONTACTS**

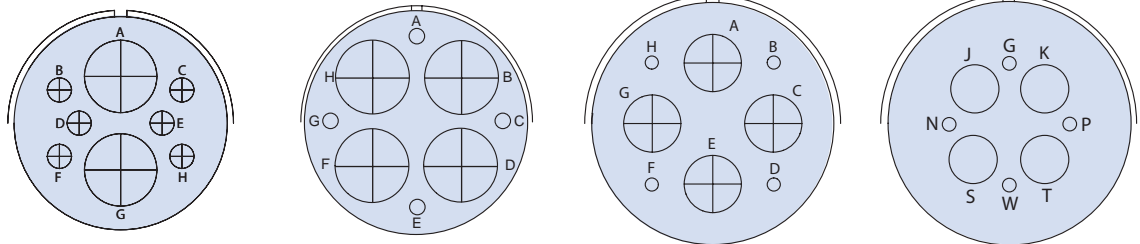

Arrangement	32-15	36-A35	40-A8	40-A10
Contact Size	2/0, 6/12	4/16, 4/0	4/0, 4/16	4/4, 4/16
Service Rating	D	A	E	D

**9 CONTACTS**

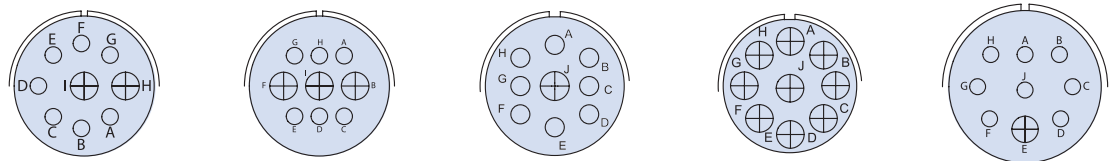

Arrangement	20-16	20-18	20-21	20-A9	22-17
Contact Size	2/12, 7/16	3/12, 6/16	1/12, 8/16	12	1/12, 8/16
Service Rating	A	A	A	J=D; Bal=A	A=D; Bal=A

**9 CONTACTS**

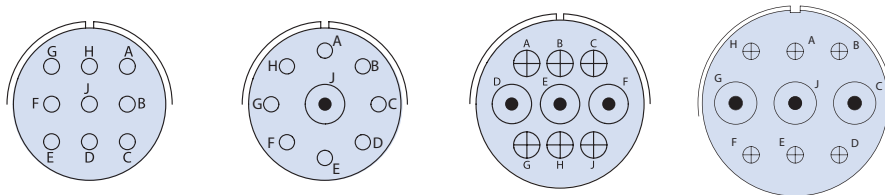

Arrangement	22-20	22-27	24-11	28-1
Contact Size	16	1/8, 8/16	3/8, 6/12	3/8, 6/12
Service Rating	A	J=D; Bal=A	A	A,J, E=D; Bal=A

**CONTACT  
LEGEND**



for Super ITS-MB Seacrow, Super ITS-RG Radgrip,  
and Super ITS-NG Nuclear-Grade Connectors

### 9 CONTACTS

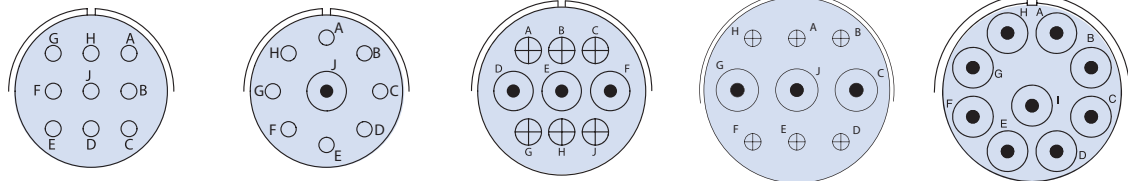

Arrangement	22-20	22-27	24-11	28-1	28-84
Contact Size	16	1/8, 8/16	3/8, 6/12	3/8, 6/12	8
Service Rating	A	J=D; Bal=A	A	A,J, E=D; Bal=A	A

### 9 CONTACTS

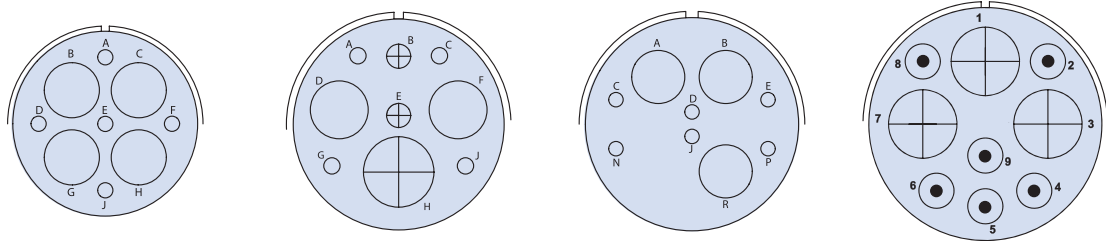

Arrangement	28-09	32-3	32-689	40-A9
Contact Size	4/4, 5/16	1/0, 2/4, 2/12, 4/16	3/4, 6/16	6/8, 3/0
Service Rating	A	D	A	A

### 10 CONTACTS

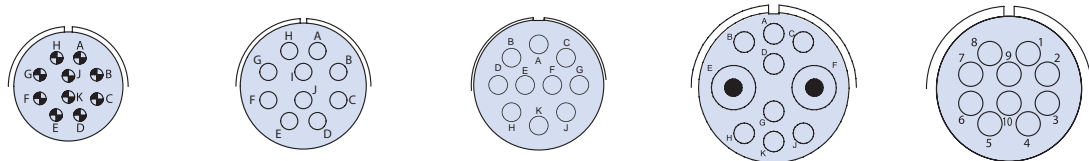

Arrangement	16-A10*	18-1	18-19	22-82	22-A10
Contact Size	18	16		8/16, 2/8	
Service Rating	I	B,C,F,G=A; Bal=I	A	A	A

#### CONTACT LEGEND



for Super ITS-MB Seacrow, Super ITS-RG Radgrip,  
and Super ITS-NG Nuclear-Grade Connectors

### 10 CONTACTS

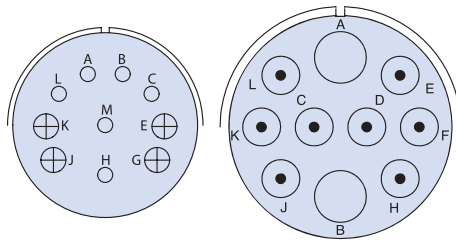

Arrangement	28-19	36-A10
Contact Size	4/12, 6/16	2/4, 8/8
Service Rating	A, B=D; K, M=B; Bal=A	A

### 11 CONTACTS

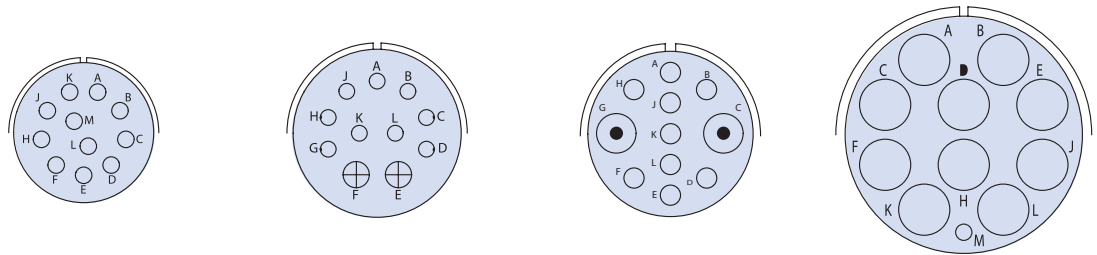

Arrangement	20-33	24-20	24-A11	40-67
Contact Size	16	2/12, 9/16	2/8, 9/16	10/4, 1/16
Service Rating	A	D	A	A

### 12 CONTACTS

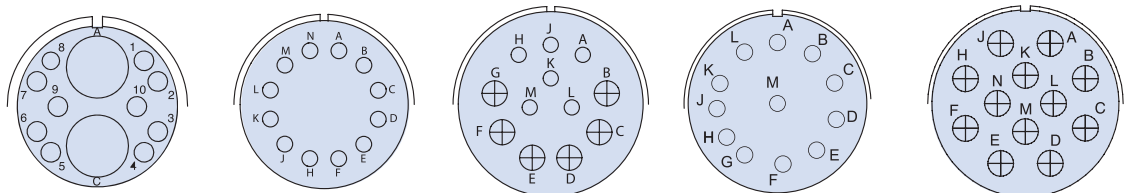

Arrangement	24-A12	24-19	28-9	28-18	28-51
Contact Size	2/4, 10/16	16	6/12, 6/16	16	12
Service Rating	A	A	D	A, B=A; G,H,J,K,L=D; M=C; Bal=I	D

#### CONTACT LEGEND



for Super ITS-MB Seacrow, Super ITS-RG Radgrip,  
and Super ITS-NG Nuclear-Grade Connectors

### 13 CONTACTS

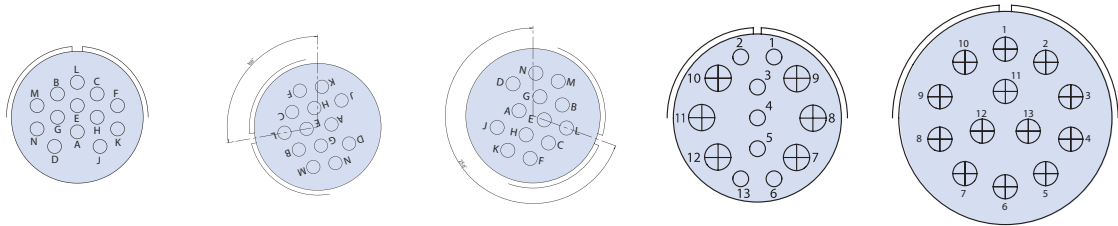

Arrangement	20-11	20-25(20-11 x 100°)	20-30 (20-11 x 250°)	24-013	32-013
Contact Size	16	16	13/16	6/12, 7/16	12
Service Rating	I	I	I	A	D

### 14 CONTACTS

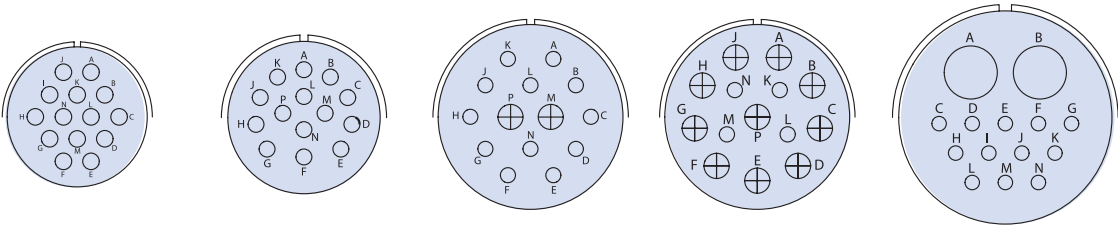

Arrangement	20-27	22-19	28-2	28-20	32-9
Contact Size			2/12, 12/16	10/12, 4/16	2/4, 12/16
Service Rating	A	A	D	A	A

### 14 CONTACTS

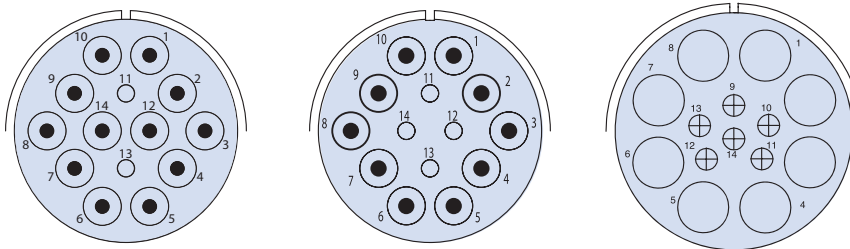

Arrangement	36-B78	36-D78	40-A14
Contact Size	12/8, 2/16	10/8, 4/16	6/12, 8/4
Service Rating	D	D	A

#### CONTACT LEGEND



for Super ITS-MB Seacrow, Super ITS-RG Radgrip,  
and Super ITS-NG Nuclear-Grade Connectors

### 15 CONTACTS

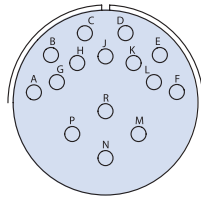

Arrangement	28-17
Contact Size	16
Service Rating	M,N,P=D; R=B; Bal=A

### 16 CONTACTS

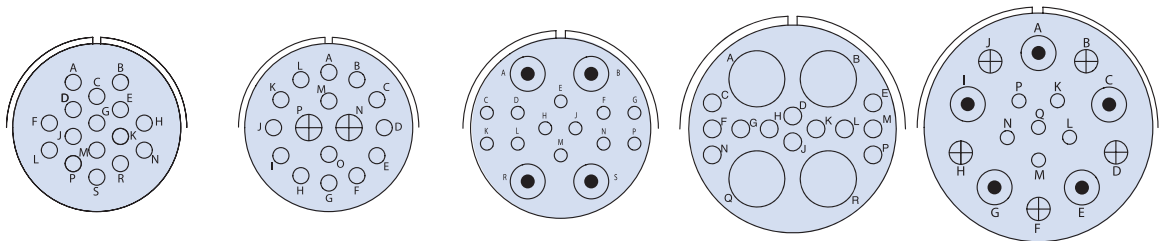

Arrangement	24-5	24-7	28-124	32-68	36-14
Contact Size	16	2/12,14/16	12/16, 4/8	4/4, 12/16	5/8, 5/12, 6/16
Service Rating	A	A	A	A	D

### 17 CONTACTS

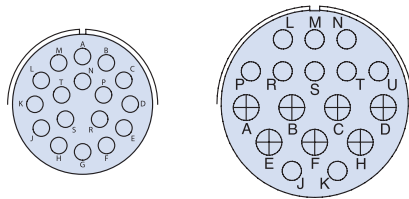

Arrangement	20-2-9	28-59
Contact Size	16	7/12, 10/16
Service Rating	A	A

#### CONTACT LEGEND



for Super ITS-MB Seacrow, Super ITS-RG Radgrip,  
and Super ITS-NG Nuclear-Grade Connectors

### 19 CONTACTS

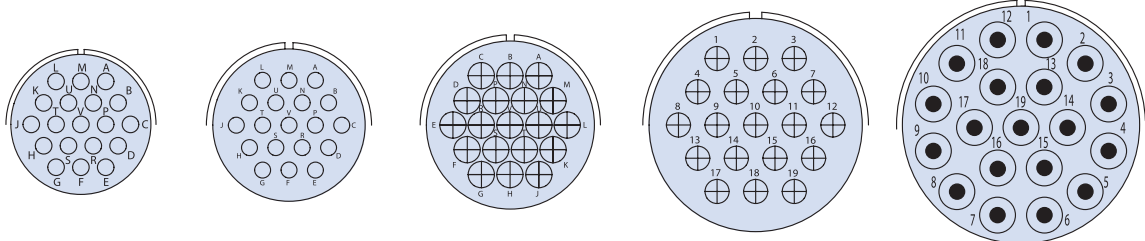

Arrangement	20-A48	22-14	24-67	32-76	40-B19
Contact Size	16	16	12	12	8
Service Rating	I	A	A	A	A

### 20 CONTACTS

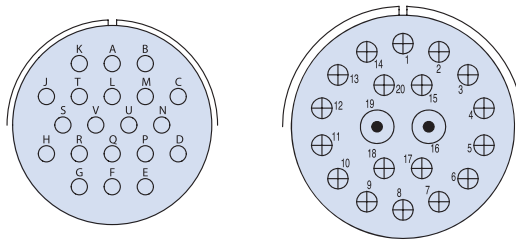

Arrangement	28-16	40-A20
Contact Size	16	2/8, 18/12
Service Rating	A	D

### 22 CONTACTS

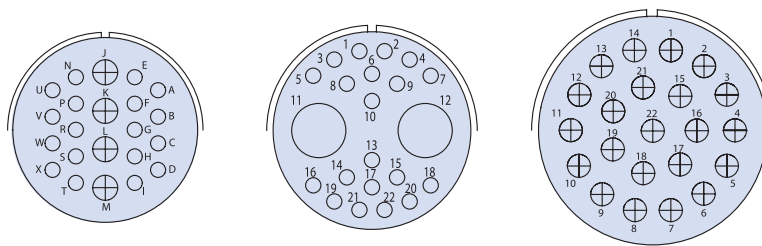

Arrangement	28-11	32-B22	36-22
Contact Size	4/12, 18/16	2/4, 20/16	12
Service Rating	A	A	D

#### CONTACT LEGEND



for Super ITS-MB Seacrow, Super ITS-RG Radgrip,  
and Super ITS-NG Nuclear-Grade Connectors

### 22 CONTACTS

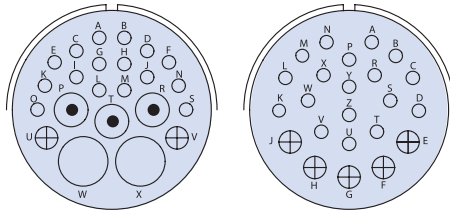

Arrangement	32-6	32-13
Contact Size	2/4, 3/8, 2/12, 16/16	5/12, 18/16
Service Rating	A	D

### 24 CONTACTS

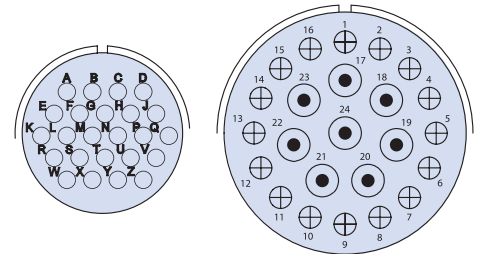

Arrangement	24-28	40-A24
Contact Size	16	8/8, 16/12
Service Rating	I	D

### 25 CONTACTS

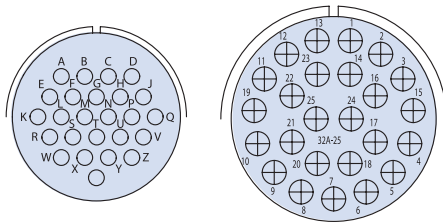

Arrangement	24-A25	32-A25
Contact Size	16	12
Service Rating	A	A

### 26 CONTACTS

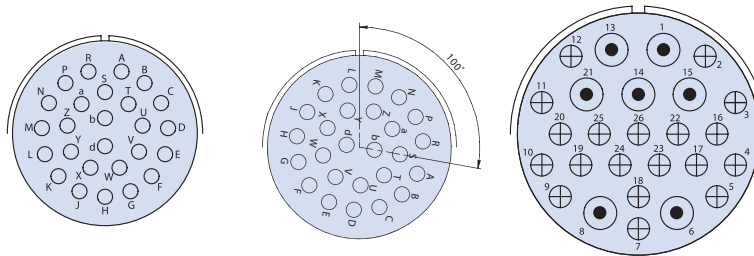

Arrangement	28-12	28-13 (28-12 x 100°)	40-26
Contact Size	16	16	7/8, 19/12
Service Rating	A	A	A

#### CONTACT LEGEND



### 27 CONTACTS

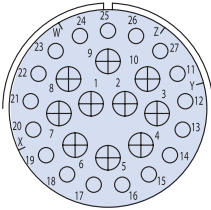

Arrangement	32-A27
Contact Size	10/12, 17/16
Service Rating	

### 28 CONTACTS

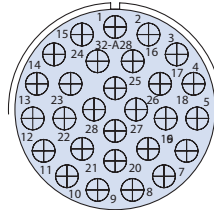
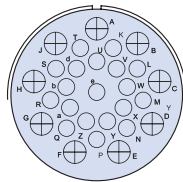
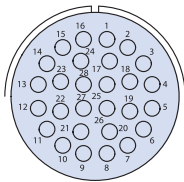

Arrangement	24-A28	28/-A63	32-A28
Contact Size	16	9/12, 19/16	12
Service Rating	I	I	A

### 29 CONTACTS

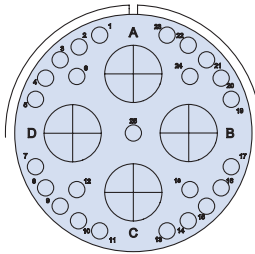
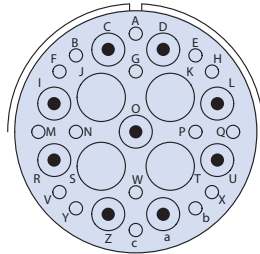
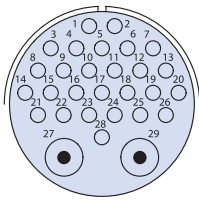

Arrangement	28-A29	40-10	40-B25
Contact Size	2/8, 27/16	4/4, 9/8, 16/16	25/16, 4/0
Service Rating	A	A	A

**CONTACT LEGEND**





for Super ITS-MB Seacrow, Super ITS-RG Radgrip,  
and Super ITS-NG Nuclear-Grade Connectors

### 30 CONTACTS

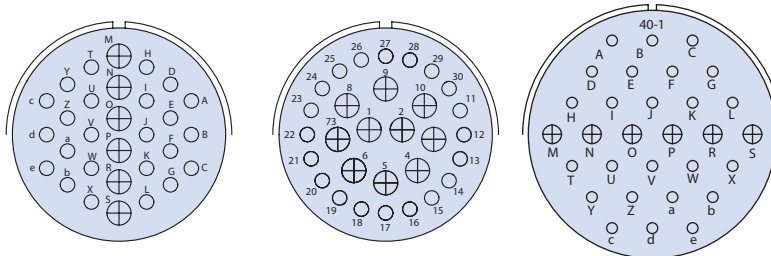

Arrangement	32-8	32-A30	40-1
Contact Size	6/12, 24/16	10/12, 20/16	6/12, 24/16
Service Rating	A	A	D

### 31 CONTACTS

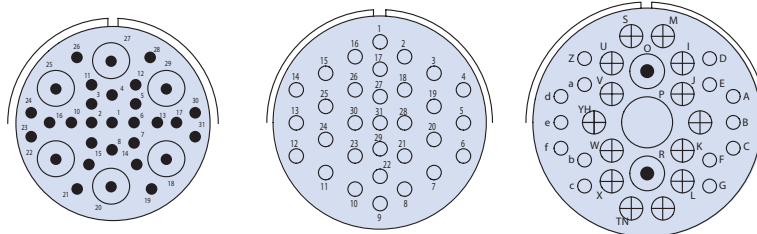

Arrangement	28-A31*	32-31	36-9
Contact Size	6/8, 25/20	16	1/4, 2//, 14/12, 14/16
Service Rating	A	A	A

### 35 CONTACTS

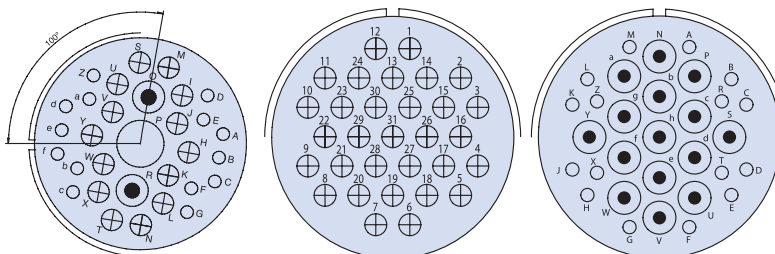

Arrangement	28/-15	28-A35	32-7
Contact Size	16	16	7/12, 28/16
Service Rating	A	A	A,B,H,J = I; Bal = A

#### CONTACT LEGEND



### 35 CONTACTS

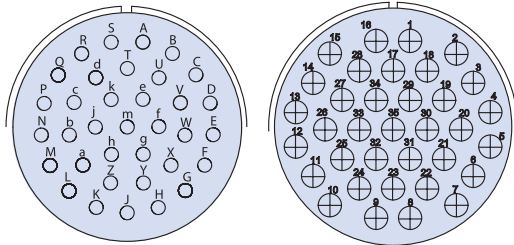

Arrangement	36-15	40-35
Contact Size	16	12
Service Rating	M = d; Bal = A	D

### 36 CONTACTS

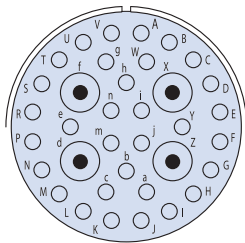

Arrangement	36-35
Contact Size	4/8, 32/16
Service Rating	A

### 37 CONTACTS

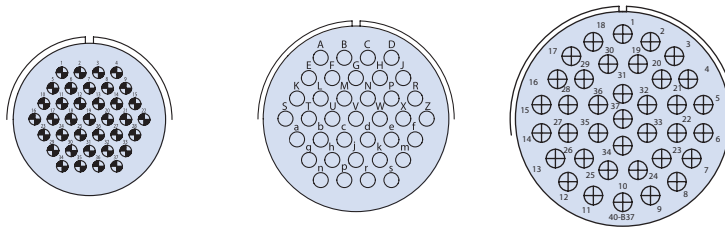

Arrangement	22-A37*	28-21	40-B37
Contact Size	18	16	12
Service Rating	A	A	A

**CONTACT LEGEND**



for Super ITS-MB Seacrow, Super ITS-RG Radgrip,  
and Super ITS-NG Nuclear-Grade Connectors

### 38 CONTACTS

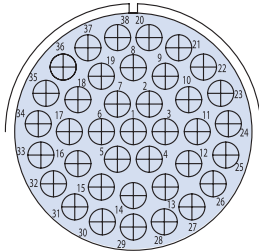

Arrangement	40-A38
Contact Size	12
Service Rating	A

### 39 CONTACTS

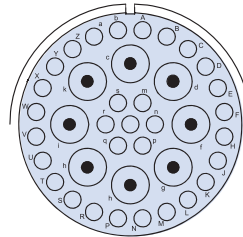

Arrangement	36-54 = 36-B39
Contact Size	8/8, 31/16
Service Rating	A

### 40 CONTACTS

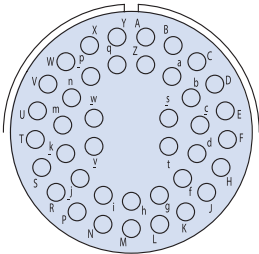

Arrangement	32-A40
Contact Size	16
Service Rating	A

### 42 CONTACTS

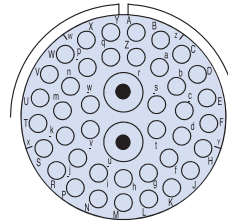

Arrangement	32-59
Contact Size	2/8, 40/16
Service Rating	A

### 44 CONTACTS

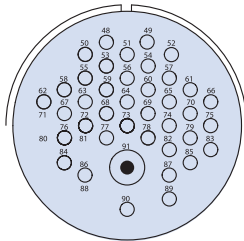

Arrangement	36-74
Contact Size	1/8, 43/16
Service Rating	A

#### CONTACT LEGEND



### 47 CONTACTS

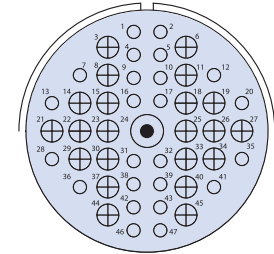
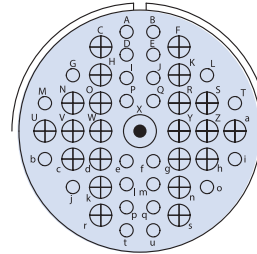
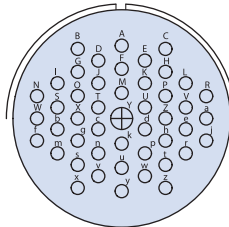
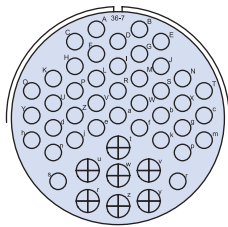

Arrangement	36-7	36-8	40-9	40-47
Contact Size	7/12, 40/16	1/12, 46/16	8, 22/12, 24/16	16 1/8, 22/12, 24/16
Service Rating	A	A	A	A

### 48 CONTACTS

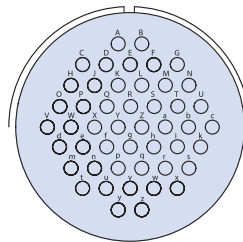
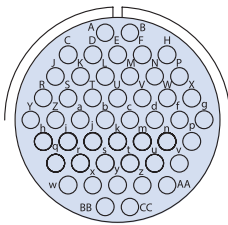

### 51 CONTACTS

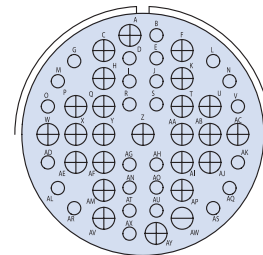

Arrangement	32-48	36-10	Arrangement	40-951
Contact Size	16	16	Contact Size	25/12, 26/16
Service Rating	I	A	Service Rating	A

### 54 CONTACTS

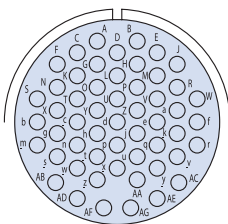
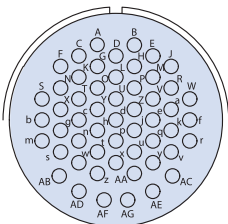

### 55 CONTACTS

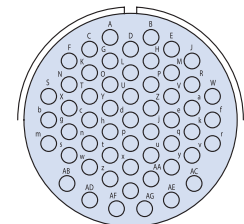
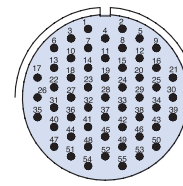

Arrangement	32-22	32-88	Arrangement	24-A55*	32-A55
Contact Size	16	16	Contact Size	20	16
Service Rating	A	A	Service Rating	I	A

#### CONTACT LEGEND



for Super ITS-MB Seacrow, Super ITS-RG Radgrip,  
and Super ITS-NG Nuclear-Grade Connectors

### 56 CONTACTS

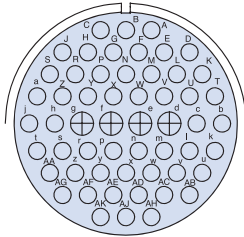

Arrangement	36-66
Contact Size	4/12, 52/16
Service Rating	A

### 60 CONTACTS

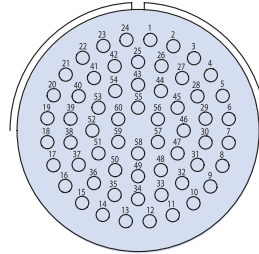

Arrangement	40-53
Contact Size	16
Service Rating	A

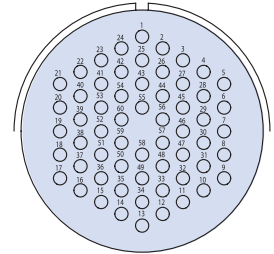

### 61 CONTACTS

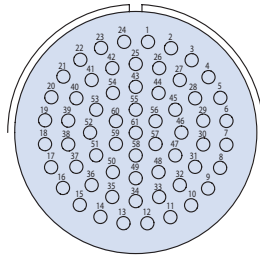

Arrangement	40-63
Contact Size	16
Service Rating	A

### 62 CONTACTS

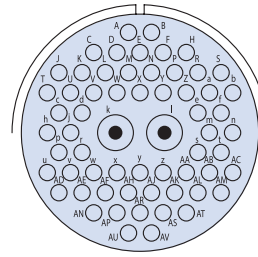

Arrangement	40-A62
Contact Size	2/8, 60/16
Service Rating	A

### 65 CONTACTS

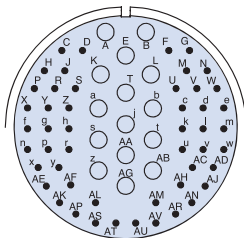

Arrangement	36-A99*
Contact Size	15/16, 50/20
Service Rating	A

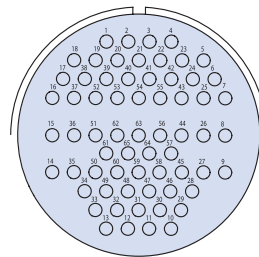

Arrangement	40-A65
Contact Size	16
Service Rating	A

### 70 CONTACTS

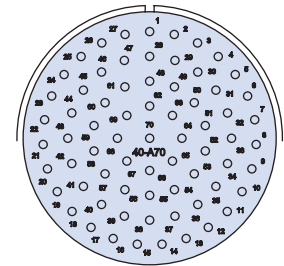

Arrangement	40-A70
Contact Size	16
Service Rating	A

#### CONTACT LEGEND



for Super ITS-MB Seacrow, Super ITS-RG Radgrig,  
and Super ITS-NG Nuclear-Grade Connectors

### 72 CONTACTS

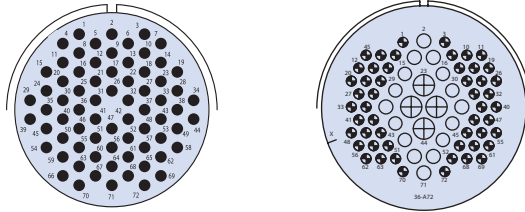

Arrangement	28-72*	36-A72*
Contact Size	20	4/12, 16/16, 52/18
Service Rating	I	I

### 85 CONTACTS

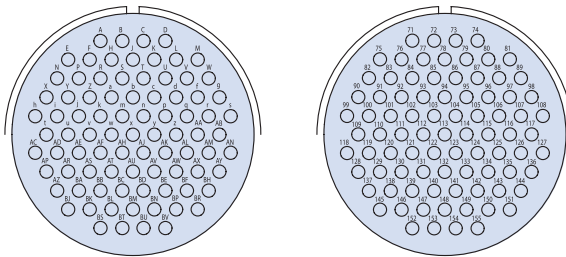

Arrangement	40-56	40-A56
Contact Size	16	16
Service Rating	A	A

### 100 CONTACTS

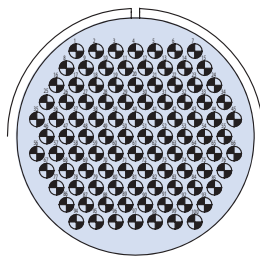

Arrangement	40-100
Contact Size	18
Service Rating	A

### 150 CONTACTS

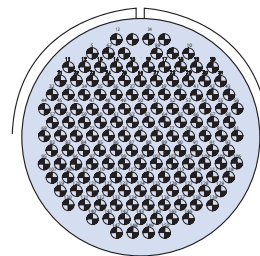

Arrangement	40-150*
Contact Size	18
Service Rating	I

#### CONTACT LEGEND



Contact Layout	A ±2™			
	W	X	Y	Z
10SL-3				
10SL-4				
14S-1	90	180	270	
14S-2		120	240	
14S-5		110		
14S-6	90			
14S-7	90	180	270	
14S-9	70	145	215	290
14S-07				
16S-1	80			280
16S-4	35	110	250	325
16S-5	70	145	215	290
16S-8		170	265	
16-2				
16-7	80	110	250	280
16-9	35	110	250	325
16-10	90	180	270	
16-11	35	110	250	325
16-12				
16-A10	35	112	235	315
18-1	70	145	215	290
18-3	35	110	250	325
18-4	35	110	250	325
18-5	80	110	250	280
18-6				
18-06	180			
18-7				
18-8	70			290
18-9	80	110	250	280
18-10		120	240	
18-10S MT				
18-11		170	265	
18-12	80			280
18-13	80	110	250	280
18-16				
18-19		120	240	

Contact Layout	A ±2™			
	W	X	Y	Z
18-20	90	180	270	
18-22	70	145	215	290
18-29	90	180	270	
18-30				
20-2				
20-3	70	145	215	290
20-4	45	110	250	
20-6	70	145	215	290
20-7	80	110	250	280
20-8	80	110	250	280
20-9	80	110	250	280
20-11				
20-14	80	110	250	280
20-15	80			280
20-16	80	110	250	280
20-17	90	180	270	
20-18	35	110	250	325
20-19	90	180	270	
20-21	35	110	250	325
20-22	80	110	250	280
20-23	35	110	250	325
20-24	35	110	250	325
20-A24	55	125	200	340
20-25				
20-27	35	110	250	325
20-29	80			280
20-30				
20-33				280
20-A8				
20-A9		110	250	
20-A48		80	280	
20-B8	80	110	250	280
22-1	35	110	250	325
22-2	70	145	215	290
22-4	35	110	250	325
22-5	35	110	250	325
22-7				
22-9	70	145	215	290
22-10	35	110	250	325
22-11	35	110	250	325
22-12	80	110	250	280
22-14	80	110	250	280

Contact Layout	A ±2™			
	W	X	Y	Z
22-15	80	110	250	280
22-17	80	110	250	280
22-18	80	110	250	280
22-19	80	110	250	280
22-20	35	110	250	325
22-21	80	110	250	280
22-22		110	250	
22-23	35		250	
22-27	80		250	280
22-28	80			280
22-34	80	110	250	280
22-82	80	110	250	280
22-A10		120	240	
22-A37	80	112	250	280
22-22S MT				
24-2	80			280
24-3	80	110	250	280
24-4	80	110	250	280
24-5	80	110	250	280
24-06	40			320
24-6	80	110	250	280
24-07	80			280
24-7	80	110	250	280
24-9	35	110	250	325
24-10	80			280
24-11	35	110	250	325
24-12	80	110	250	280
24-013				
24-19				
24-20	80	110	250	280
24-22	45	110	250	
24-27	80			280
24-28	80	110	250	280
24-67	80			335
24-A1				
24-A8				
24-A11	35	110	250	325
24-A12				
24-A25	80	110	250	280
24-A28	65	146	235	
24-A55	80	110	250	280
24-G5	70	110	240	270
28-1	80	110	250	280
28-2	35	110	250	325

Insert Rotation (front view)

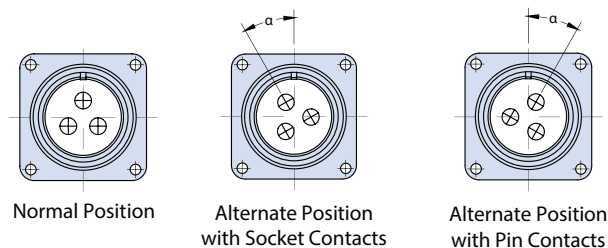



Contact Layout	A ±2™			
	W	X	Y	Z
28-3	70	145	215	290
28-6	70	145	215	290
28-09	110	250	260	280
28-9	80	110	250	280
28-10	80	110	250	280
28-11	80	110	250	280
28-12	90	180	270	
28-13				
28-15	80	110	250	280
28-16	80	110	250	280
28-17	80	110	250	280
28-18	70	145	215	290
28-19	80	110	250	280
28-20	80	110	250	280
28-21	80	110	250	280
28-22	70	145	215	290
28-51	80	135	190	
28-59	35	110	250	325
28-70	80			280
28-72	72	144	216	288
28-84	45	157	90	135
28-124	80	110	250	280
28-A29	80	110	250	280
28-A31	35		260	310
28-A35	80	110	250	280
28-A63		100	260	
28-B1				
28-B2				
32-1	80	110	250	280
32-2	70	145	215	290
32-3	80	110	250	280
32-5	35	110	250	325
32-6	80	110	250	280
32-7	80	125	235	280
32-8	80	125	235	280
32-9	80	110	250	280
32-013	65	130	230	295
32-13	80	110	250	280
32-15	35	110	250	280
32-17	45	110	250	
32-22	80	110	250	280
32-31	80	125	215	280
32-59	36	108	252	324
32-68	65	135	225	275

Contact Layout	A ±2™			
	W	X	Y	Z
32-689				
32-A5 GM				
32-76	80	110	250	280
32-79				
32-88	80	110	250	280
32-A1				
32-A3	22	44	76	98
32-A8	35	122		315
32-A25	60	120		
32-A27	30	115	285	335
32-A28				
32-A30				
32-A40	35	130		
32-A48	80	125	235	
32-A55	80	110	250	280
32-B22	35	110	250	325
36-01				
36-3	70	145	215	290
36-4	70	145	215	290
36-5		120	240	
36-6	35	110	250	325
36-7	80	110	250	280
36-8	80	110	250	280
36-9	80	125	235	280
36-10	80	125	235	280
36-14	90	180	270	
36-15	60	125	245	305
36-18				
36-22	80	110	250	280
36-35				
36-54 = 36-B39	67			
36-66	110	250	260	280
36-74				
36-77	45	90		
36-A7				
36-A10	45	110	250	315
36-A35				
36-A51	45	135	225	315
36-A72		110		
36-A99	30	135		
36-B61				
36-B78	35	106	254	325

Contact Layout	A ±2™			
	W	X	Y	Z
36-B90				
36-D78	35	106	254	325
40-1	65	130	235	300
40-9	65	125	225	310
40-10	65	125	225	310
40-26	80	110	250	280
40-31	80	110	250	280
40-35	70	130	230	290
40-47	65	125	225	310
40-53	80	110	250	280
40-56	72	144	216	288
40-62	30	130	220	290
40-63	80			280
40-67	70	110	230	280
40-100	30	105	230	315
40-150				
40-951	90	105		
40-A3	70	145	215	290
40-A4	50	120	240	325
40-A5	33			270
40-A6	35	110	250	280
40-A5GM	33			270
40-A8	35	110	250	325
40-A9				
40-A10	65			
40-A14				
40-A20	80	110	250	280
40-A24				
40-A38	37			
40-A51				
40-A55				
40-A56	72	144	216	288
40-A62	80	130	230	280
40-A65	70	145	215	285
40-A70	80	110	250	280
40-B4	45	110	215	300
40-B19	35	105	255	325
40-B25				
40-B37				
40-D4				
40-G4				

Insert Rotation (front view)

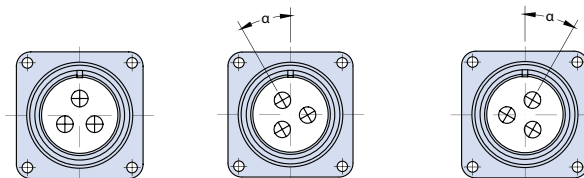

Normal Position

Alternate Position  
with Socket Contacts

Alternate Position  
with Pin Contacts



**PANEL CUTOUT DIMENSIONS**

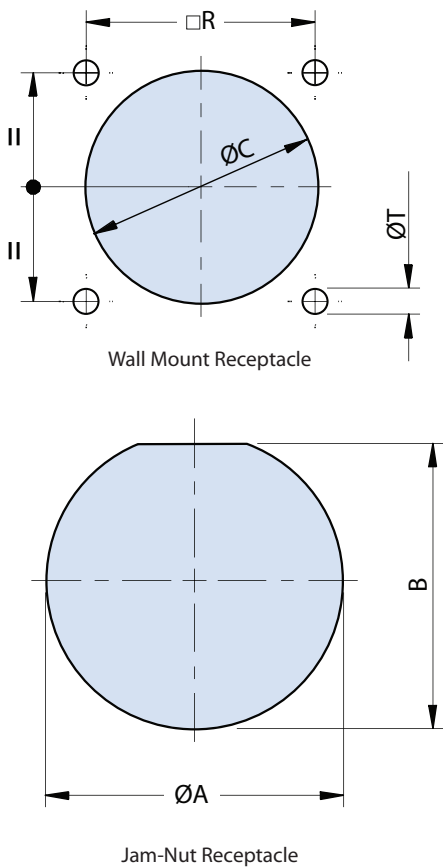

**Panel Cutout for Type 00, 02, 26 Connectors (Front Panel Mounting)**

Shell Size	10SL	14S	16S, 16	18	20	22	24	28	32	36	40
ØC	17 (0.67)	20 (0.79)	23 (0.91)	26.5 (1.04)	30 (1.18)	33 (1.30)	36 (1.42)	42 (1.65)	48.50 (1.91)	55 (2.17)	61 (2.40)
R ±0.1	18.2 (0.72)	23.0 (0.91)	24.6 (0.97)	27 (1.06)	29.4 (1.16)	31.8 (1.25)	34.9 (1.37)	39.7 (1.56)	44.5 (1.75)	49.2 (1.94)	55.5 (2.19)
ØT	3.4 (0.13)	3.4 (0.13)	3.4 (0.13)	3.4 (0.13)	3.4 (0.13)	3.4 (0.13)	3.9 (0.15)	3.9 (0.15)	4.5 (0.18)	4.5 (0.18)	4.5 (0.18)

**Panel Cutout for Type 03, 030, 038, 02PP Connectors (Rear Panel Mounting)**

Shell Size	10SL	14S	16S, 16	18	20	22	24	28	32	36	40
ØC	19.1 (0.75)	25.5 (1.00)	28.3 (1.11)	31.7 (1.25)	35 (1.38)	38.3 (1.51)	41.8 (1.65)	47.6 (1.87)	54.3 (2.14)	60.5 (2.38)	66.4 (2.61)
R ±0.1	18.2 (0.72)	23.0 (0.91)	24.6 (0.97)	27 (1.06)	29.4 (1.16)	31.8 (1.25)	34.9 (1.37)	39.7 (1.56)	44.5 (1.75)	49.2 (1.94)	55.5 (2.19)
ØT	4.5 (0.18)	4.5 (0.18)	4.5 (0.18)	4.5 (0.18)	4.5 (0.18)	4.5 (0.18)	4.5 (0.18)	5.5 (0.22)	5.5 (0.22)	5.5 (0.22)	5.5 (0.22)

**Panel Cutout for Type 07, 070, 078 Connectors (Jam-Nut Receptacles)**

Shell Size	10SL	14S	16S, 16	18	20	22	24	28	32	36	40
ØA + 0.25	22.40 (0.88)	28.75 (1.13)	31.95 (1.26)	35.10 (1.38)	38.30 (1.51)	41.45 (1.63)	44.65 (1.76)	51.00 (2.01)	57.35 (2.26)	63.70 (2.51)	70.05 (2.76)
ØB - 0.35	21.00 (0.83)	27.40 (1.08)	30.95 (1.22)	33.75 (1.33)	36.85 (1.45)	40.05 (1.58)	43.35 (1.71)	49.55 (1.95)	55.95 (2.20)	62.35 (2.45)	68.55 (2.70)

**Panel Mount Recommended Torque (Nm)**

Screw Size	Shell Material		
	Alum.	Marine Bronze	SST
M4	1.1	1.6	2
M5	2.1	2.9	3.7

**Jam Nut Torque for Type 07, 070, 078**

Shell Size	10SL	14S	16S, 16	18, 20	22	24, 28	32	36	40
Torque [Nm]	18	28	30	35	40	45	50	55	60

**MAXIMUM PANEL THICKNESS**

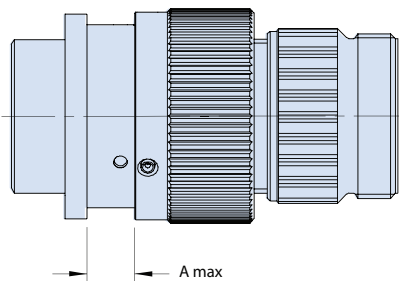

**Panel Thickness for Type 00, 02 Rear Panel Mount Connectors**

Shell Size	10SL	14S	16S, 16	18	20	22	24	28	32	36	40
A Max	3.7 (0.15)	3.7 (0.15)	3.7 (0.15)	3.7 (0.15)	3.7 (0.15)	3.7 (0.15)	5.25 (0.21)	5.25 (0.21)	6.1 (0.24)	6.1 (0.24)	6 (0.24)

**Panel Thickness for Type 02PP, 03, 030 and 038 RPM Wall Mount Connectors (Thrd)**

Shell Size	10SL	14S	16S, 16	18	20	22	24	28	32	36	40
A Max	7.2 (0.28)	7.2 (0.28)	7.2 (0.28)	7.5 (0.30)	7.5 (0.30)	7.5 (0.30)	7.5 (0.30)	7.5 (0.30)	7.5 (0.30)	7.5 (0.30)	7.5 (0.30)

**Panel Thickness for Type 02PP, 03, 030 and 038 Connectors**

Shell Size	10SL	14S	16S, 16	18	20	22	24	28	32	36	40
A Max	2.5 (0.10)	2.5 (0.10)	2.5 (0.10)	3.2 (0.13)	3.2 (0.13)	3.2 (0.13)	3.2 (0.13)	3.2 (0.13)	3.2 (0.13)	3.2 (0.13)	3.2 (0.13)

Contact Specifications*				
Contact Size	Rated Current at 20° C	Rated Current at 80° C	Max. Contact resist.	Wire size
20	7.5 A	7.5 A	12.0 mW	20-26 AWG
18	10A	7.5 A	12.0 mW	18-26 AWG
16	22 A	13 A	6.0 mW	16-22 AWG
12	41 A	23 A	3.0 mW	12-14 AWG
8	73 A	46 A	1.0 mW	8-10 AWG
4	135 A	80 A	0.5 mW	4-6 AWG
0	245 A	150 A	0.3 mW	0-2 AWG
4/0	350 A	225 A	0.2 mW	4/0 AWG

Service Rating*			
Service Rating Class	Operating Voltage VDC	Operating Voltage VAC RMS	Test Voltage VAC RMS
Instrument	250 V	200 V	1000 V
A	700 V	500 V	2000 V
D	1250 V	900 V	2800 V
E	1750 V	1250 V	3500 V
B	2450 V	1750 V	4500 V
C	4200 V	3000 V	7000 V

\*Minimum Insulating resistance:  $\geq 5 \times 10^3$  MΩ

\*Copper alloy / silver plated (standard) or gold plated (upon request)

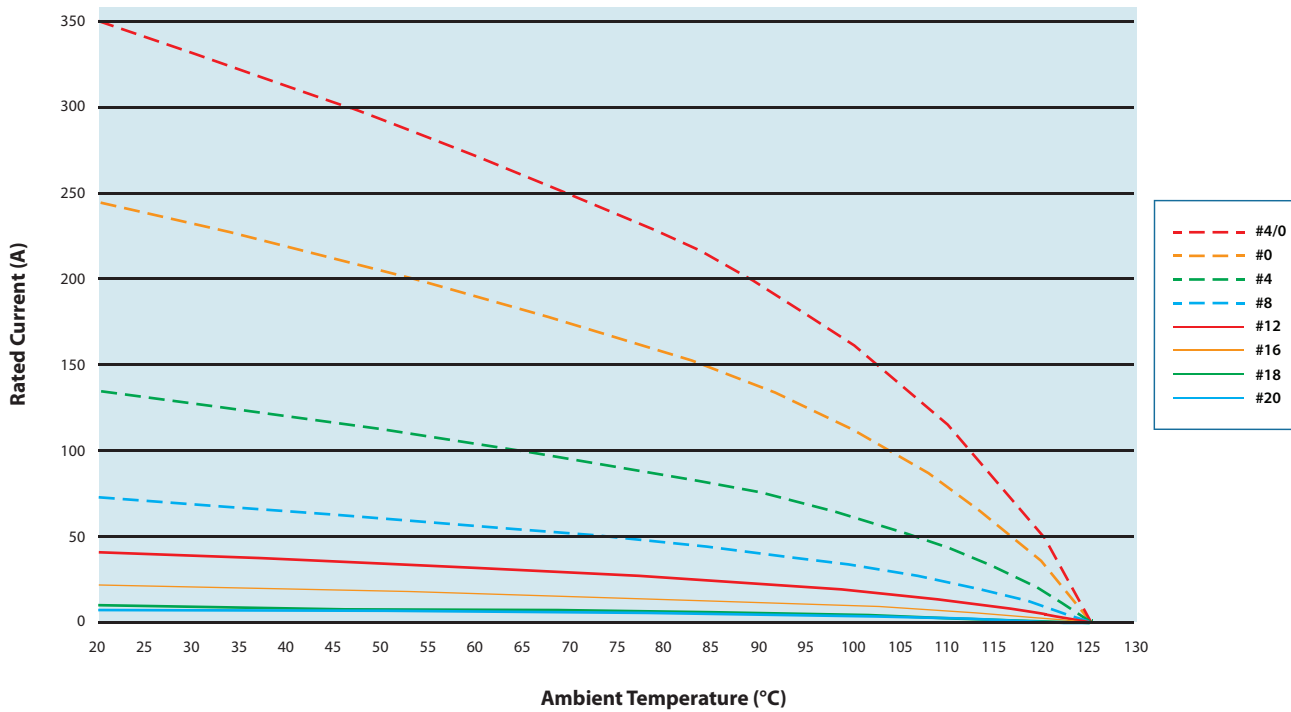

### INSULATING PARTS

High insulation synthetic rubber resistant to oils and high temperatures (-55°C to +125°C) in accordance with MIL-R-3065. All connectors are also available in fire resistant and halogen free materials.

**PIN CRIMP CONTACTS - MANUAL AND PNEUMATIC TOOLS**

Manual And Pneumatic Tools Part Numbers, Size & Dimensions							
Part Number	Contact Size	Wire Size		Manual Crimp Tool		Pneumatic Tool Type "A"	
		mm <sup>2</sup>	AWG	Manual Tool	Turret	Pneumatic Tool	Turret
10-375-20	20	0.15-0.6	26-20	M.105001	M.105026	M.105003	M.105026
10-40579	18	0.15-0.6	26-20	M.105001	M.105025	M.105003	M.105025
10-40553	16S	1-1.5	18-16	M.105007	M.105009	M.105002	M.105009
10-40553-12	16S	0.6	20	M.105007	M.105009	M.105002	M.105009
10-40553-13	16S	0.15-0.6	26-20	M.105001	M.105009	M.105003	M.105009
10-40553-15	16S	0.75-1.0	18	M.105007	M.105009	M.105002	M.105009
10-40553-20	16S	1-2	14	M.105007	M.105009	M.105002	M.105009
10-40553-26	16S	2.5-3.0	12	M.105007	M.105009	M.105002	M.105009
10-40557	16	1-1.5	18-16	M.105007	M.105009	M.105002	M.105012
10-40557L	16	1-1.5	18-16	M.105007	M.105012	M.105002	M.105009
10-40557-08	16	0.15-0.2	26-24	M.105001	M.105009	M.105003	M.105009
10-40557-12	16	0.6	20	M.105007	M.105009	M.105003	M.105009
10-40557-13	16	0.15-0.6	26-20	M.105001	M.105009	M.105003	M.105009
10-40557-15	16	0.75-1.0	18	M.105007	M.105009	M.105002	M.105009
10-40557-20	16	1-2	14	M.105007	M.105009	M.105002	M.105009
10-40557-22	16	2.5	/	M.105007	M.105009	M.105002	M.105009
10-40557-22L	16	2.5	/	M.105007	M.105012	M.105002	M.105012
10-40557-26	16	2.5-3.0	12	M.105007	M.105009	M.105002	M.105009
10-40557-32	16	/	32-28	M.105007	M.105009	M.105003	M.105009
10-40561	12	2.5-3.0	12	M.105007	M.105009	M.105002	M.105009
10-40561-12	12	0.6	20	M.105007	M.105009	M.105003	M.105009
10-40561-15	12	0.75-1.0	18	M.105007	M.105009	M.105002	M.105009
10-40561-177	12	1.5	18-16	M.105007	M.105009	M.105002	M.105009
10-40561-20	12	2	14	M.105007	M.105009	M.105002	M.105009
10-40561-22	12	2.5	/	M.105007	M.105009	M.105002	M.105009
10-40561-30	12	4-5	/	M.105007	M.105009	M.105002	M.105009
10-40561-30M	12	4	/	M.105007	M.105009	M.105002	M.105009
10-40561-38	12	6	10	M.105007	M.105009	M.105002	M.105009

Please consult our sales department for other contacts or crimp tooling details.



Manual Crimp Tool



Turret for Manual Crimp Tool



Pneumatic Crimp Tool Type "A"



Turret for Pneumatic Crimp Tool Type "A"

**PIN CRIMP CONTACTS - MANUAL AND PNEUMATIC TOOLS**

SUPER ITS: APPENDIX - INSERT ARRANGEMENTS / ACCESSORIES

Manual And Pneumatic Tools Part Numbers, Size & Dimensions										
Part Number	Contact Size	Wire Size		Manual Crimp Tool		Pneumatic Tool Type "B"			Oleodinamic Tool	
		Mm <sup>2</sup>	Awg	Tool	Turret	Tool	Die	Locator	Tool	Die
10-40792	8	9	8	/	/	M.112000	M.112001	M.112309	M.112004	M.112005
10-40792-15	8	0.75-1.0	18	M.105028	M.104002	/	/	/	/	/
10-40792-18	8	1-2	18-14	M.105028	M.104002	/	/	/	/	/
10-40792-20	8	2	14	M.105028	M.104002	/	/	/	/	/
10-40792-26	8	2.5-3.0	12	M.105028	M.104002	/	/	/	/	/
10-40792-30	8	4-5	/	M.105028	M.104002	/	/	/	M.112004	M.112008
10-40792-38	8	6	10	/	/	M.112000	M.112001	M.112309-1	M.112004	M.112005
10-40792-50	8	10	/	/	/	M.112000	M.112001	M.112309-1	M.112004	M.112005
10-40792-58	8	13.2	6	/	/	M.112000	M.112001	M.112309-1	M.112004	M.112005
10-113474-4P	4	25	4	/	/	M.112000	M.112002	M.112311	M.112004	M.112006
10-113474-4P-22	4	2.5	/	/	/	/	/	/	M.112004	M.112009
10-113474-4P-25	Replaced by 10-113474-4P									
10-113474-4P-26	4	2.5-3.0	12	/	/	/	/	/	M.112004	M.112009
10-113474-4P-30	4	4-5	/	/	/	/	/	/	M.112004	M.112008
10-113474-4P-38	4	6	10	/	/	M.112000	M.112001	M.112311	M.112004	M.112005
10-113474-4P-50	4	10	/	/	/	M.112000	M.112001	M.112311	M.112004	M.112005
10-113474-4P-58	4	13.2	6	/	/	M.112000	M.112001	M.112311	M.112004	M.112005
10-113474-4P-62	4	16	/	/	/	M.112000	M.112002	M.112311	M.112004	M.112006
10-113474-1P	0	50-60	0	/	/	M.112000	M.112003	M.112313	M.112004	M.112010
10-113474-1P-107	0	50	/	/	/	M.112000	M.112003	M.112313	M.112004	M.112010
10-113474-1P-72	0	22-25	4	/	/				M.112004	M.112006
10-113474-1P-35	0	35	/	/	/	/	/	/	M.112004	M.112007
10-113474-1P-45	0	9	8	/	/				M.112004	M.112005
10-113474-1P-50	0	10	/	/	/				M.112004	M.112005
10-113474-1P-58	0	13.2	6	/	/				M.112004	M.112005
10-113474-1P-62	0	16	/	/	/				M.112004	M.112006
10-113474-0P	4/0	107	4/0	/	/	/	/	/	M.105013	M.112012
10-113474-0P-78	4/0	25	/	/	/	/	/	/	M.112004	M.112006
10-113474-0P-107	4/0	50	/	/	/	/	/	/	M.112004	M.112010
10-113474-0P-144	4/0	70	/	/	/	/	/	/	M.105013	M.105053

Please consult our sales department for other contacts or crimp tooling details.



Pneumatic Crimp Tool Type "B"



Die For Pneumatic Crimp Tool Type "B"



Locator for Pneumatic Crimp Tool Type "B"



Oleodinamic Crimp Tool



Die for Oleodinamic Crimp Tool

**PIN CRIMP CONTACTS - INSERTION AND REMOVAL TOOLS**

Insertion and Removal Tools Part Numbers and Dimensions					
Part Number	Contact Size	Wire Size		Insertion tool	Removal Tool
		mm <sup>2</sup>	AWG		
10-375-20	20	0.15-0.6	26-20	M.117346	M.118251
10-40579	18	0.15-0.6	26-20	M.117346	M.118249
10-40553	16S	1-1.5	18-16	M.117083	M.118250
10-40553-12	16S	0.6	20	M.117083	M.118250
10-40553-13	16S	0.15-0.6	26-20	M.117346	M.118250
10-40553-15	16S	0.75-1.0	18	M.117083	M.118250
10-40553-20	16S	1-2	14	M.117083	M.118250
10-40553-26	16S	2.5-3.0	12	M.117082	M.118250
10-40557	16	1-1.5	18-16	M.117083	M.118250
10-40557L	16	1-1.5	18-16	M.117083	M.118250
10-40557-08	16	0.15-0.2	26-24	M.117346	M.118250
10-40557-12	16	0.6	20	M.117083	M.118250
10-40557-13	16	0.15-0.6	26-20	M.117346	M.118250
10-40557-15	16	0.75-1.0	18	M.117083	M.118250
10-40557-20	16	1-2	14	M.117083	M.118250
10-40557-22	16	2.5	/	M.117083	M.118250
10-40557-22L	16	2.5	/	M.117083	M.118250
10-40557-26	16	2.5-3.0	12	M.117083	M.118250
10-40557-32	16	/	32-28	M.117083	M.118250
10-40561	12	2.5-3.0	12	M.117082	M.118250
10-40561-12	12	0.6	20	M.117083	M.118250
10-40561-15	12	0.75-1.0	18	M.117083	M.118250
10-40561-177	12	1.5	18-16	M.117082	M.118250
10-40561-20	12	2	14	M.117082	M.118250
10-40561-22	12	2.5	/	M.117082	M.118250
10-40561-30	12	4-5	/	M.117082	M.118250
10-40561-30M	12	4	/	M.117082	M.118250
10-40561-38	12	6	10	M.117082	M.118250

Insertion and Removal Tools Part Numbers and Dimensions					
Part Number	Contact Size	Wire Size		Insertion tool	Removal Tool
		mm <sup>2</sup>	AWG		
10-40792	8	9	8	M.117344	M.118260
10-40792-15	8	0.75-1.0	18	M.117082	M.118260
10-40792-18	8	1-2	18-14	M.117082	M.118260
10-40792-20	8	2	14	M.117082	M.118260
10-40792-26	8	2.5-3.0	12	M.117082	M.118260
10-40792-30	8	4-5	/	M.117082	M.118260
10-40792-38	8	6	10	M.117344	M.118260
10-40792-50	8	10	/	M.117344	M.118260
10-40792-58	8	13.2	6	M.117344	M.118260
10-113474-4P	4	25	4	M.117347	M.118270
10-113474-4P-22	4	2.5	/	M.117082	M.118270
10-113474-4P-26	4	2.5-3.0	12	M.117082	M.118270
10-113474-4P-30	4	4-5	/	M.117082	M.118270
10-113474-4P-38	4	6	10	M.117344	M.118270
10-113474-4P-50	4	10	/	M.117344	M.118270
10-113474-4P-58	4	13.2	6	M.117344	M.118270
10-113474-4P-62	4	16	/	M.117347	M.118270
10-113474-1P	0	50-60	0	M.117348	M.118280
10-113474-1P-107	0	50	/	M.117348	M.118280
10-113474-1P-72	0	22-25	4	M.117347	M.118280
10-113474-1P-35	0	35	/	M.117348	M.118280
10-113474-1P-45	0	9	8	M.117344	M.118280
10-113474-1P-50	0	10	/	M.117344	M.118280
10-113474-1P-58	0	13.2	6	M.117344	M.118280
10-113474-1P-62	0	16	/	M.117347	M.118280
10-113474-0P	4/0	107	4/0	/	/
10-113474-0P-78	4/0	25	/	/	/
10-113474-0P-107	4/0	50	/	/	/
10-113474-0P-144	4/0	70	/	/	/

**SUPER ITS: APPENDIX - INSERT ARRANGEMENTS / ACCESSORIES**



Insertion Tool



Removal Tool

Please consult our sales department for other contact options or crimp tool details.



**SOCKET CRIMP CONTACTS - MANUAL AND PNEUMATIC TOOLS**

SUPER ITS: APPENDIX - INSERT ARRANGEMENTS / ACCESSORIES

Manual And Pneumatic Tools Part Numbers, Size & Dimensions							
Part Number	Contact Size	Wire Size		Manual Crimp Tool		Pneumatic Tool Type "A"	
		mm <sup>2</sup>	AWG	Manual Tool	Turret	Pneumatic Tool	Turret
10-40520LC	20	0.15-0.6	26-20	M.105001	M.105026	M.105003	M.105026
10-40588	18	0.15-0.6	26-20	M.105001	M.105025	M.105003	M.105025
10-40552	16S	1-1.5	18-16	M.105007	M.105009	M.105002	M.105009
10-40552-12	16S	0.6	20	M.105007	M.105009	M.105002	M.105009
10-40552-13	16S	0.15-0.6	26-20	M.105001	M.105009	M.105003	M.105009
10-40552-15	16S	0.75-1	18	M.105007	M.105009	M.105002	M.105009
10-40552-20	16S	1-2	14	M.105007	M.105009	M.105002	M.105009
10-40552-26	16S	2.5-3.0	12	M.105007	M.105009	M.105002	M.105009
10-40556	16	1-1.5	18-16	M.105007	M.105009	M.105002	M.105009
10-40556-08	16	0.15-0.2	26-24	M.105001	M.105009	M.105003	M.105009
10-40556-12	16	0.6	20	M.105007	M.105009	M.105003	M.105009
10-40556-13	16	0.15-0.6	26-20	M.105001	M.105009	M.105003	M.105009
10-40556-15	16	0.75-1	18	M.105007	M.105009	M.105002	M.105009
10-40556-20	16	1-2	14	M.105007	M.105009	M.105002	M.105009
10-40556-22	16	2.5	/	M.105007	M.105009	M.105002	M.105009
10-40556-26	16	2.5-3.0	12	M.105007	M.105009	M.105002	M.105009
10-40556-32	16	/	32-28	M.105007	M.105009	M.105003	M.105009
10-40560	12	2.5-3.0	12	M.105007	M.105009	M.105002	M.105009
10-40560-12	12	0.6	20	M.105007	M.105009	M.105003	M.105009
10-40560-15	12	0.75-1	18	M.105007	M.105009	M.105002	M.105009
10-40560-177	12	1.5	18-16	M.105007	M.105009	M.105002	M.105009
10-40560-20	12	2	14	M.105007	M.105009	M.105002	M.105009
10-40560-22	12	2.5	/	M.105007	M.105009	M.105002	M.105009
10-40560-30	12	4-5	/	M.105007	M.105009	M.105002	M.105009
10-40560-30M	12	4	/	M.105007	M.105009	M.105002	M.105009
10-40560-38	12	6	10	M.105007	M.105009	M.105002	M.105009

Please consult our sales department for other contacts or crimp tooling details.



Manual Crimp Tool



Turret for Manual Crimp Tool



Pneumatic Crimp Tool Type "A"



Turret for Pneumatic Crimp Tool Type "A"



**SOCKET CRIMP CONTACTS - MANUAL AND PNEUMATIC TOOLS**

Manual and Pneumatic Tools Part Numbers, Size & Dimensions										
Part Number	Contact Size	Wire Size		Manual Crimp Tool		Pneumatic Tool Type "B"			Oleodynamic Tool	
		mm	AWG	Tool	Turret	Tool	Die	Locator	Tool	Die
10-40793-1	8	9	8	/	/	M.112000	M.112001	M.112309	M.112004	M.112005
10-40793-1-15	8	0.75-1	18	M.105028	M.104002	/	/	/	/	/
10-40793-1-18	8	1-2	18-14	M.105028	M.104002	/	/	/	/	/
10-40793-1-20	8	2	14	M.105028	M.104002	/	/	/	/	/
10-40793-1-26	8	2.5-3.0	12	M.105028	M.104002	/	/	/	/	/
10-40793-1-30	8	4-5	/	M.105028	M.104002	/	/	/	M.112004	M.112008
10-40793-1-38	8	6	10	/	/	M.112000	M.112001	M.112309	M.112004	M.112005
10-40793-1-50	8	10	/	/	/	M.112000	M.112001	M.112309	M.112004	M.112005
10-10793-1-58	8	13.2	6	/	/	M.112000	M.112001	M.112309	M.112004	M.112005
10-113474-4S-1	4	25	4	/	/	M.112000	M.112002	M.112311	M.112004	M.112006
10-113474-4S-1-22	4	2.5	/	/	/	/	/	/	M.112004	M.112009
10-113474-4S-1-25	Replaced by 10-113474-4S-1									
10-113474-4S-1-26	4	2.5-3.0	12	/	/	/	/	/	M.112004	M.112009
10-113474-4S-1-30	4	4-5	/	/	/	/	/	/	M.112004	M.112008
10-113474-4S-1-38	4	6	10	/	/	M.112000	M.112001	M.112311	M.112004	M.112005
10-113474-4S-1-50	4	10	/	/	/	M.112000	M.112001	M.112311	M.112004	M.112005
10-113474-4S-1-58	4	13.2	6	/	/	M.112000	M.112001	M.112311	M.112004	M.112005
10-113474-4S-62	4	16	/	/	/	M.112000	M.112002	M.112311	M.112004	M.112006
10-113474-1S	0	50-60	0	/	/	M.112000	M.112003	M.112313	M.112004	M.112010
10-113474-1S-107	0	50	/	/	/	M.112000	M.112003	M.112313	M.112004	M.112010
10-113474-1S-72	0	22-25	4	/	/	M.112000	M.112002	M.112313	M.112004	M.112006
10-113474-1S-35	0	35	/	/	/	/	/	/	M.112004	M.112007
10-113474-1S-45	0	9	8	/	/	/	/	/	M.112004	M.112005
10-113474-1S-50	0	10	/	/	/	/	/	/	M.112004	M.112005
10-113474-1S-58	0	13.2	6	/	/	/	/	/	M.112004	M.112005
10-113474-1S-62	0	16	/	/	/	/	/	/	M.112004	M.112006
10-113474-0S	4/0	107	4/0	/	/	/	/	/	M.105013	M.112012
10-113474-0S-78	4/0	25	/	/	/	/	/	/	M.112004	M.112006
10-113474-0S-107	4/0	50	/	/	/	/	/	/	M.112004	M.112010
10-113474-0S-144	4/0	70	/	/	/	/	/	/	M.105013	M.105053

Please consult our sales department for other contacts or crimp tooling details.



Pneumatic Crimp Tool Type "B"



Die For Pneumatic Crimp Tool Type "B"



Locator for Pneumatic Crimp Tool Type "B"



Oleodynamic Crimp Tool



Die for Oleodynamic Crimp Tool

**PIN CRIMP CONTACT - INSERTION AND REMOVAL TOOLS**

Insertion and Removal Tools					
Part Number	Contact Size	Wire Size		Insertion Tool	Removal Tool
10-375-20	20	0.15-0.6	26-20	M.117346	M.118251
10-40579	18	0.15-0.6	26-20	M.117346	M.118249
10-40553	16S	1-1.5	18-16	M.117083	M.118250
10-40553-12	16S	0.6	20	M.117083	M.118250
10-40553-13	16S	0.15-0.6	26-20	M.117346	M.118250
10-40553-15	16S	0.75-1.0	18	M.117083	M.118250
10-40553-20	16S	1-2	14	M.117083	M.118250
10-40553-26	16S	2.5-3.0	12	M.117082	M.118250
10-40557	16	1-1.5	18-16	M.117083	M.118250
10-40557L	16	1-1.5	18-16	M.117083	M.118250
10-40557-08	16	0.15-0.2	26-24	M.117346	M.118250
10-40557-12	16	0.6	20	M.117083	M.118250
10-40557-13	16	0.15-0.6	26-20	M.117346	M.118250
10-40557-15	16	0.75-1.0	18	M.117083	M.118250
10-40557-20	16	1-2	14	M.117083	M.118250
10-40557-22	16	2.5	/	M.117083	M.118250
10-40557-22L	16	2.5	/	M.117083	M.118250
10-40557-26	16	2.5-3.0	12	M.117083	M.118250
10-40557-32	16	/	32-28	M.117083	M.118250
10-40561	12	2.5-3.0	12	M.117082	M.118250
10-40561-12	12	0.6	20	M.117083	M.118250
10-40561-15	12	0.75-1.0	18	M.117083	M.118250
10-40561-177	12	1.5	18-16	M.117082	M.118250
10-40561-20	12	2	14	M.117082	M.118250
10-40561-22	12	2.5	/	M.117082	M.118250
10-40561-30	12	4-5	/	M.117082	M.118250
10-40561-30M	12	4	/	M.117082	M.118250
10-40561-38	12	6	10	M.117082	M.118250
10-40792	8	9	8	M.117344	M.118260

Insertion and Removal Tools					
Part Number	Contact Size	Wire Size		Insertion Tool	Removal Tool
10-40792-15	8	0.75-1.0	18	M.117082	M.118260
10-40792-18	8	1-2	18-14	M.117082	M.118260
10-40792-20	8	2	14	M.117082	M.118260
10-40792-26	8	2.5-3.0	12	M.117082	M.118260
10-40792-30	8	4-5	/	M.117082	M.118260
10-40792-38	8	6	10	M.117344	M.118260
10-40792-50	8	10	/	M.117344	M.118260
10-40792-58	8	13.2	6	M.117344	M.118260
10-113474-4P	4	25	4	M.117347	M.118270
10-113474-4P-22	4	2.5	/	M.117082	M.118270
10-113474-4P-26	4	2.5-3.0	12	M.117082	M.118270
10-113474-4P-30	4	4-5	/	M.117082	M.118270
10-113474-4P-38	4	6	10	M.117344	M.118270
10-113474-4P-50	4	10	/	M.117344	M.118270
10-113474-4P-58	4	13.2	6	M.117344	M.118270
10-113474-4P-62	4	16	/	M.117347	M.118270
10-113474-1P	0	50-60	0	M.117348	M.118280
10-113474-1P-107	0	50	/	M.117348	M.118280
10-113474-1P-72	0	22-25	4	M.117347	M.118280
10-113474-1P-35	0	35	/	M.117348	M.118280
10-113474-1P-45	0	9	8	M.117344	M.118280
10-113474-1P-50	0	10	/	M.117344	M.118280
10-113474-1P-58	0	13.2	6	M.117344	M.118280
10-113474-1P-62	0	16	/	M.117347	M.118280
10-113474-0P	4/0	107	4/0	/	/
10-113474-0P-78	4/0	25	/	/	/
10-113474-0P-107	4/0	50	/	/	/
10-113474-0P-144	4/0	70	/	/	/

Please consult our sales department for other contacts or crimp tooling details.



Insertion Tool



Removal Tool



**SOCKET CRIMP CONTACT - INSERTION AND REMOVAL TOOLS**

Insertion and Removal Tool Part Numbers and Dimensions					
Part Number	Contact Size	Wire Size		Insertion tool	Removal Tool
		mm <sup>2</sup>	AWG		
10-40520LC	20	0.15-0.6	26-20	M.117346	M.118251
10-40588	18	0.15-0.6	26-20	M.117346	M.118249
10-40552	16S	1-1.5	18-16	M.117083	M.118250
10-40552-12	16S	0.6	20	M.117083	M.118250
10-40552-13	16S	0.15-0.6	26-20	M.117346	M.118250
10-40552-15	16S	0.75-1	18	M.117083	M.118250
10-40552-20	16S	1-2	14	M.117083	M.118250
10-40552-26	16S	2.5-3.0	12	M.117082	M.118250
10-40556	16	1-1.5	18-16	M.117083	M.118250
10-40556-08	16	0.15-0.2	26-24	M.117346	M.118250
10-40556-12	16	0.6	20	M.117083	M.118250
10-40556-13	16	0.15-0.6	26-20	M.117346	M.118250
10-40556-15	16	0.75-1	18	M.117083	M.118250
10-40556-20	16	1-2	14	M.117083	M.118250
10-40556-22	16	2.5	/	M.117083	M.118250
10-40556-26	16	2.5-3.0	12	M.117082	M.118250
10-40556-32	16	/	32-28	M.117083	M.118250
10-40560	12	2.5-3.0	12	M.117082	M.118250
10-40560-12	12	0.6	20	M.117083	M.118250
10-40560-15	12	0.75-1	18	M.117083	M.118250
10-40560-177	12	1.5	18-16	M.117082	M.118250
10-40560-20	12	2	14	M.117082	M.118250
10-40560-22	12	2.5	/	M.117082	M.118250
10-40560-30	12	4-5	/	M.117082	M.118250
10-40560-30M	12	4	/	M.117082	M.118250
10-40560-38	12	6	10	M.117082	M.118250
10-40793-1	8	9	8	M.117344	M.118260
10-40793-1-15	8	0.75-1	18	M.117082	M.118260
10-40793-1-18	8	1-2	18-14	M.117082	M.118260

Insertion and Removal Tool Part Numbers and Dimensions					
Part Number	Contact Size	Wire Size		Insertion tool	Removal Tool
		mm <sup>2</sup>	AWG		
10-40793-1-20	8	2	14	M.117082	M.118260
10-40793-1-26	8	2.5-3.0	12	M.117082	M.118260
10-40793-1-30	8	4-5	/	M.117082	M.118260
10-40793-1-38	8	6	10	M.117344	M.118260
10-40793-1-50	8	10	/	M.117344	M.118260
10-10793-1-58	8	13.2	6	M.117344	M.118260
10-113474-4S-1	4	22-25	4	M.117347	M.118270
10-113474-4S-1-22	4	2.5	/	M.117082	M.118270
10-113474-4S-1-26	4	2.5-3.0	12	M.117082	M.118270
10-113474-4S-1-30	4	4-5	/	M.117082	M.118270
10-113474-4S-1-38	4	6	10	M.117344	M.118270
10-113474-4S-1-50	4	10	/	M.117344	M.118270
10-113474-4S-1-58	4	13.2	6	M.117344	M.118270
10-113474-4S-1-62	4	16	/	M.117347	M.118270
10-113474-1S	0	50-60	0	M.117348	M.118280
10-113474-1S-107	0	50	/	M.117348	M.118280
10-113474-1S-72	0	22-25	4	M.117347	M.118280
10-113474-1S-35	0	35	/	M.117348	M.118280
10-113474-1S-45	0	9	8	M.117344	M.118280
10-113474-1S-50	0	10	/	M.117344	M.118280
10-113474-1S-58	0	13.2	6	M.117344	M.118280
10-113474-1S-62	0	16	/	M.117347	M.118280
10-113474-0S	4/0	107	4/0	/	/
10-113474-0S-78	4/0	22-25	4	/	/
10-113474-0S-107	4/0	50	/	/	/
10-113474-0S-144	4/0	70	/	/	/

Please consult our sales department for other contact options or crimping tool details.



Insertion Tool



Removal Tool



Guide Pin

Guide Pin	
Contact size	Guide Pin P/N
20	M.125007
18	M.125000
16S and 16	M.125001
12	M.125002
8	M.125003
4	n/a
0	n/a
4/0	N/A

### CRIMP PIN CONTACTS

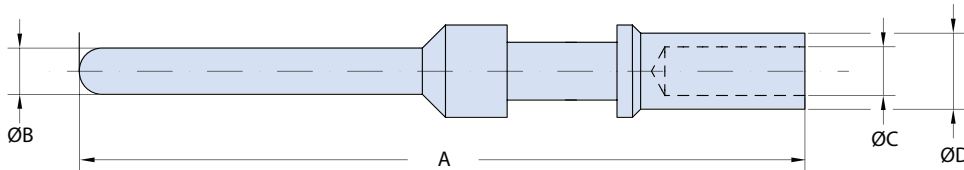

**PLATING OPTIONS**  
G10 : Silver (Standard)  
G117 : Gold

Pin Crimp Contact Part Number, Size and Dimensions

Part Number	Contact Size	A	ØB	ØC	ØD	Wire Size	
						mm <sup>2</sup>	AWG
10-375-20	20	24.30 (0.957)	1.00 (0.039)	.30 (0.012)	1.93 (0.076)	0.15-0.6	26-20
10-40579	18	29.60 (1.165)	1.40 (0.055)	1.30 (0.051)	1.93 (0.076)	0.15-0.6	26-20
10-40553	16S	26.60 (1.047)	1.58 (0.062)	1.70 (0.067)	2.60 (0.102)	1-1.5	18-16
10-40553-12	16S	26.60 (1.047)	1.58 (0.062)	1.19 (0.047)	2.59 (0.102)	0.6	20
10-40553-13 <sup>1</sup>	16S	26.60 (1.047)	1.58 (0.062)	1.30 (0.051)	1.93 (0.076)	0.15-0.6	26-20
10-40553-15 <sup>1</sup>	16S	26.60 (1.047)	1.58 (0.062)	1.50 (0.059)	2.60 (0.102)	0.75-1.0	18
10-40553-20	16S	26.60 (1.047)	1.58 (0.062)	2.00 (0.079)	2.90 (0.114)	2	14
10-40553-26	16S	26.60 (1.047)	1.58 (0.062)	.50 (0.020)	3.8 (0.150)	2.5-3.0	12
10-40557	16	31.75 (1.250)	1.58 (0.062)	1.70 (0.067)	2.60 (0.102)	1-1.5	18-16
10-40557L	16	33.25 (1.309)	1.58 (0.062)	1.70 (0.067)	2.60 (0.102)	1-1.5	18-16
10-40557-08 <sup>1</sup>	16	31.75 (1.250)	1.58 (0.062)	0.85 (0.033)	1.55 (0.061)	0.15-0.2	26-24
10-40557-12 <sup>1</sup>	16	31.75 (1.250)	1.58 (0.062)	1.20 (0.047)	2.60 (0.102)	0.6	20
10-40557-13 <sup>1</sup>	16	31.75 (1.250)	1.58 (0.062)	1.30 (0.051)	.93 (0.037)	0.15-0.6	26-20
10-40557-15 <sup>1</sup>	16	31.75 (1.250)	1.58 (0.062)	1.50 (0.059)	2.60 (0.102)	0.75-1.0	18
10-40557-20 <sup>2</sup>	16	31.75 (1.250)	1.58 (0.062)	2.00 (0.079)	2.90 (0.114)	2	14
10-40557-22 <sup>2</sup>	16	31.75 (1.250)	1.57 (0.062)	2.2 (0.087)	3.8 (0.150)	2.5	/
10-40557-22L <sup>2</sup>	16	33.25 (1.309)	1.57 (0.062)	2.2 (0.087)	3.8 (0.150)	2.5	/
10-40557-26 <sup>2</sup>	16	31.75 (1.250)	1.58 (0.062)	2.5 (0.098)	3.8 (0.150)	2.5-3.0	12
10-40557-32 <sup>1</sup>	16	31.75 (1.250)	1.58 (0.062)	0.45 (0.018)	1.95 (0.077)	/	32-28
10-40561	12	37.65 (1.482)	2.38 (0.094)	2.50 (0.098)	3.90 (0.154)	2.5-3.0	12
10-40561-12 <sup>1</sup>	12	37.65 (1.482)	2.38 (0.094)	1.20 (0.047)	2.60 (0.102)	0.6	20
10-40561-15 <sup>1</sup>	12	37.65 (1.482)	2.38 (0.094)	1.50 (0.059)	2.60 (0.102)	0.75-1.0	18
10-40561-177 <sup>1</sup>	12	37.65 (1.482)	2.38 (0.094)	1.77 (0.070)	2.75 (0.108)	1.5	18-16
10-40561-20 <sup>1</sup>	12	37.65 (1.482)	2.38 (0.094)	2.00 (0.079)	3.90 (0.154)	2	14
10-40561-22 <sup>1</sup>	12	37.65 (1.482)	2.38 (0.094)	2.10 (0.083)	3.90 (0.154)	2.5	/
10-40561-30 <sup>2</sup>	12	37.65 (1.482)	2.38 (0.094)	3.00 (0.118)	4.80 (0.189)	4-5	/
10-40561-30M <sup>2</sup>	12	37.65 (1.482)	2.38 (0.094)	3.30 (0.130)	4.20 (0.165)	4	/
10-40561-38 <sup>2</sup>	12	37.65 (1.482)	2.38 (0.094)	3.60 (0.142)	4.8 (0.189)	6	10

### APPLICATION NOTES

- These contacts accept smaller wire than standard contacts. There may be a sealing issues with grommets. The max current rating is limited by the wire max current rating.
- These contacts accept larger wires than standard contacts. The reduced air/creepage resistance may worsen the service rating and there may be sealing issues with grommets. The max current rating is limited by the contact max current rating. See Page A-33
- Please consult our factory for other contact options or crimp tool details.

**CRIMP PIN CONTACT**

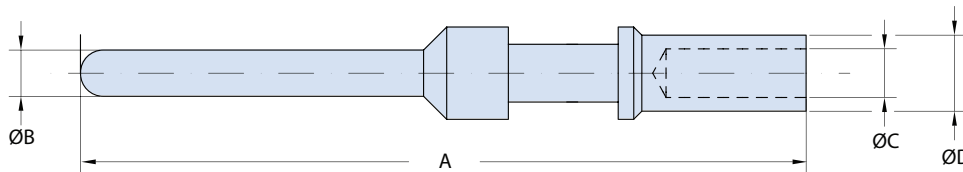

**PLATING OPTIONS**  
G10 : Silver (Standard)  
G117 : Gold

Pin Crimp Contact Part Number, Size and Dimensions							
Part Number	Contact Size	A	ØB	ØC	ØD	Wire Size	
						mm2	AWG
10-40792	8	42.00 (1.654)	3.60 (0.142)	4.50 (0.177)	6.90 (0.272)	9	8
10-40792-15 <sup>1</sup>	8	42.00 (1.654)	3.60 (0.142)	1.50 (0.059)	3.40 (0.134)	0.75-1.0	18
10-40792-18 <sup>1</sup>	8	42.00 (1.654)	3.60 (0.142)	1.80 (0.071)	3.80 (0.150)	1.2	18.14
10-40792-20 <sup>1</sup>	8	42.00 (1.654)	3.60 (0.142)	2.00 (0.079)	3.80 (0.150)	2	14
10-40792-26 <sup>1</sup>	8	42.00 (1.654)	3.60 (0.142)	2.5 (0.098)	3.80 (0.150)	2.5-3.0	12
10-40792-30 <sup>1</sup>	8	42.00 (1.654)	3.60 (0.142)	3.00 (0.118)	4.80 (0.189)	4-5	/
10-40792-38 <sup>1</sup>	8	42.00 (1.654)	3.60 (0.142)	3.60 (0.142)	6.80 (0.268)	6	10
10-40792-50 <sup>2</sup>	8	42.00 (1.654)	3.60 (0.142)	5.00 (0.197)	6.90 (0.272)	10	/
10-40792-58 <sup>2</sup>	8	42.00 (1.654)	3.60 (0.142)	5.80 (0.228)	7.80 (0.307)	13.2	6
10-113474-4P	4	42.00 (1.654)	5.70 (0.224)	7.10 (0.280)	9.53 (0.375)	22-25	4
10-113474-4P-22 <sup>1</sup>	4	42.00 (1.654)	5.70 (0.224)	2.20 (0.087)	3.80 (0.150)	2.5	/
10-113474-4P-25	Replaced by 10-113474-4P						
10-113474-4P-26 <sup>1</sup>	4	42.00 (1.654)	5.70 (0.224)	2.50 (0.098)	3.80 (0.150)	2.5-3.0	12
10-113474-4P-30 <sup>1</sup>	4	42.00 (1.654)	5.70 (0.224)	3.00 (0.118)	4.80 (0.189)	4-5	/
10-113474-4P-38 <sup>1</sup>	4	42.00 (1.654)	5.70 (0.224)	3.60 (0.142)	6.80 (0.268)	6	10
10-113474-4P-50 <sup>1</sup>	4	42.00 (1.654)	5.70 (0.224)	5.00 (0.197)	7.00 (0.276)	10	/
10-113474-4P-58 <sup>1</sup>	4	42.00 (1.654)	5.70 (0.224)	5.80 (0.228)	7.80 (0.307)	13.2	6
10-113474-4P-62 <sup>1</sup>	4	42.00 (1.654)	5.70 (0.224)	6.20 (0.244)	9.53 (0.375)	16	/
10-113474-1P	0	45.00 (1.772)	9.05 (0.356)	11.50 (0.453)	14.30 (0.563)	50-60	0
10-113474-1P-107 <sup>1</sup>	0	45.00 (1.772)	9.05 (0.356)	10.70 (0.421)	14.35 (0.565)	50	/
10-113474-1P-72 <sup>1</sup>	0	45.00 (1.772)	9.05 (0.356)	7.15 (0.281)	9.50 (0.374)	22-25	4
10-113474-1P-35 <sup>1</sup>	0	45.00 (1.772)	9.05 (0.356)	9.00 (0.354)	14.35 (0.565)	35	/
10-113474-1P-45 <sup>1</sup>	0	45.00 (1.772)	9.05 (0.356)	4.55 (0.179)	6.80 (0.268)	9	8
10-113474-1P-50 <sup>1</sup>	0	45.00 (1.772)	9.05 (0.356)	5.00 (0.197)	7.00 (0.276)	10	/
10-113474-1P-58 <sup>1</sup>	0	45.00 (1.772)	9.05 (0.356)	5.80 (0.228)	7.80 (0.307)	13.2	6
10-113474-1P-62 <sup>1</sup>	0	45.00 (1.772)	9.05 (0.356)	6.20 (0.244)	9.50 (0.374)	16	/
10-113474-0P <sup>1</sup>	4/0	63.00 (2.480)	12.69 (0.500)	16.5 (0.650)	20 (0.787)	107	4/0
10-113474-0P-78 <sup>1</sup>	4/0	63.00 (2.480)	12.69 (0.500)	7.10 (0.280)	9.53 (0.375)	22-25	4
10-113474-0P-107 <sup>1</sup>	4/0	63.00 (2.480)	12.69 (0.500)	10.7 (0.421)	14.35 (0.565)	50	/
10-113474-0P-144 <sup>1</sup>	4/0	63.00 (2.480)	12.69 (0.500)	14.5 (0.571)	20 (0.787)	70	/

**APPLICATION NOTES**

1. These contacts accept smaller wire than standard contacts. There may be a sealing issues with grommets. The max current rating is limited by the wire max current rating.
2. These contacts accept larger wires than standard contacts. The reduced air/creepage resistance may worsen the service rating and there may be sealing issues with grommets. The max current rating is limited by the contact max current rating. See Page A-33
3. Please contact factory for options.
4. Please consult our sales department for other contacts or crimp tooling details.

**CRIMP SOCKET CONTACTS**

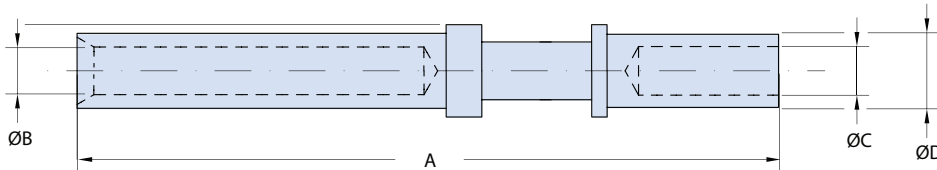

**PLATING OPTIONS**  
G10 : Silver (Standard)  
G117 : Gold

SUPER ITS: APPENDIX - INSERT ARRANGEMENTS / ACCESSORIES

Socket Crimp Contact Part Number, Size and Dimensions							
Part Number	Contact Size	A	ØB	ØC	ØD	Wire Size	
						mm2	AWG
10-40588	18	34.4 (1.35)	1.46 (0.057)	1.3 (0.051)	1.93 (0.076)	0.15-0.6	26-20
10-40552	16S	26.6 (1.05)	1.65 (0.065)	1.7 (0.067)	2.60 (0.102)	1-1.5	18-16
10-40552-12 <sup>1</sup>	16S	26.6 (1.05)	1.65 (0.065)	1.2 (0.047)	2.60 (0.102)	0.6	20
10-40552-13 <sup>1</sup>	16S	26.6 (1.05)	1.65 (0.065)	1.3 (0.051)	1.93 (0.076)	0.15-0.6	26-20
10-40552-15 <sup>1</sup>	16S	26.6 (1.05)	1.65 (0.065)	1.5 (0.059)	2.60 (0.102)	0.75-1	18
10-40552-20 <sup>2</sup>	16S	26.6 (1.05)	1.65 (0.065)	2.0 (0.079)	2.90 (0.114)	2	14
10-40552-26 <sup>2</sup>	16S	26.6 (1.05)	1.65 (0.065)	2.5 (0.098)	3.80 (0.150)	2.5-3.0	12
10-40556	16	36.5 (1.44)	1.65 (0.065)	1.7 (0.067)	2.60 (0.102)	1-1.5	18-16
10-40556-08 <sup>1</sup>	16	36.5 (1.44)	1.65 (0.065)	.85 (0.033)	1.55 (0.061)	0.15-0.2	26-24
10-40556-12 <sup>1</sup>	16	36.5 (1.44)	1.65 (0.065)	1.2 (0.047)	2.60 (0.102)	0.6	20
10-40556-13 <sup>1</sup>	16	36.5 (1.44)	1.65 (0.065)	1.3 (0.051)	1.93 (0.076)	0.15-0.6	26-20
10-40556-15 <sup>1</sup>	16	36.5 (1.44)	1.65 (0.065)	1.45 (0.057)	2.60 (0.102)	0.75-1	18
10-40556-20 <sup>2</sup>	16	36.5 (1.44)	1.65 (0.065)	2.0 (0.079)	2.90 (0.114)	2	14
10-40556-22 <sup>2</sup>	16	36.5 (1.44)	1.65 (0.065)	2.2 (0.087)	3.8 (0.150)	2.5	/
10-40556-26 <sup>2</sup>	16	36.5 (1.44)	1.65 (0.065)	2.5 (0.098)	3.80 (0.150)	2.5-3.0	12
10-40556-32 <sup>1</sup>	16	36.5 (1.44)	1.65 (0.065)	.45 (0.018)	1.95 (0.077)	/	32-28
10-40560	12	37.65 (1.48)	2.48 (0.098)	2.5 (0.098)	3.9 (0.154)	2.5-3.0	12
10-40560-12 <sup>1</sup>	12	37.65 (1.48)	2.48 (0.098)	1.2 (0.047)	2.6 (0.102)	0.6	20
10-40560-15 <sup>1</sup>	12	37.65 (1.48)	2.48 (0.098)	1.45 (0.057)	2.60 (0.102)	0.75-1	18
10-40560-17 <sup>1</sup>	12	37.65 (1.48)	2.48 (0.098)	1.77 (0.070)	2.75 (0.108)	1.5	18-16
10-40560-20 <sup>1</sup>	12	37.65 (1.48)	2.48 (0.098)	2.0 (0.079)	3.8 (0.150)	2	14
10-40560-22 <sup>1</sup>	12	37.65 (1.48)	2.48 (0.098)	2.1 (0.083)	3.8 (0.150)	2.5	/
10-40560-30 <sup>2</sup>	12	37.65 (1.48)	2.38 (0.094)	3.00 (0.118)	4.80 (0.189)	4-5	/
10-40560-30M <sup>2</sup>	12	37.65 (1.48)	2.38 (0.094)	3.30 (0.130)	4.20 (0.165)	4	/
10-40560-38 <sup>2</sup>	12	37.65 (1.48)	2.38 (0.094)	3.60 (0.142)	4.80 (0.189)	6	10

**APPLICATION NOTES**

- These contacts accept smaller wire than standard contacts. There may be a sealing issues with grommets. The max current rating is limited by the wire max current rating.
- These contacts accept larger wires than standard contacts. The reduced air/creepage resistance may worsen the service rating and there may be sealing issues with grommets. The max current rating is limited by the contact max current rating. See Page A-33
- Please contact factory for options.
- Please consult our sales department for other contacts or crimp tooling details.

**CRIMP SOCKET CONTACTS**

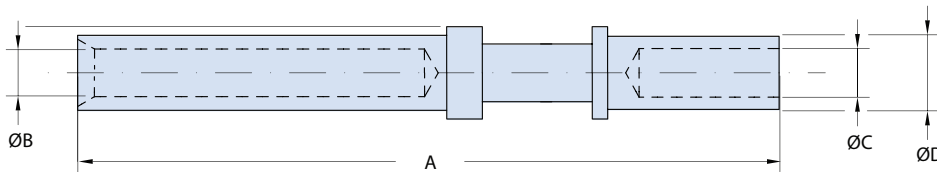

**PLATING OPTIONS**  
G10 : Silver (Standard)  
G117 : Gold

Socket Crimp Contact Part Number, Size and Dimensions							
Part Number	Contact Size	A	ØB	ØC	ØD	Wire Size	
						mm2	AWG
10-40793-1	8	40.5 (1.59)	3.70 (0.146)	4.5 (0.177)	6.75 (0.266)	9	8
10-40793-1-15 <sup>1</sup>	8	40.5 (1.59)	3.70 (0.146)	1.45 (0.057)	3.4 (0.134)	0.75-1	18
10-40793-1-18 <sup>1</sup>	8	40.5 (1.59)	3.70 (0.146)	1.8 (0.071)	3.8 (0.150)	1-2	18-14
10-40793-1-20 <sup>1</sup>	8	40.5 (1.59)	3.60 (0.142)	2.00 (0.079)	3.80 (0.150)	2	14
10-40793-1-26 <sup>1</sup>	8	40.5 (1.59)	3.70 (0.146)	2.5 (0.098)	3.8 (0.150)	2.5-3.0	12
10-40793-1-30 <sup>1</sup>	8	40.5 (1.59)	3.70 (0.146)	3.0 (0.118)	4.8 (0.189)	4-5	/
10-40793-1-38 <sup>1</sup>	8	40.5 (1.59)	3.70 (0.146)	3.6 (0.142)	6.8 (0.268)	6	10
10-40793-1-50 <sup>2</sup>	8	40.5 (1.59)	3.70 (0.146)	5.0 (0.197)	6.9 (0.272)	10	/
10-40793-1-58 <sup>2</sup>	8	40.5 (1.59)	3.70 (0.146)	5.8 (0.228)	7.8 (0.307)	13.2	6
10-113474-4S-1	4	41.0 (1.61)	5.80 (0.228)	7.1 (0.280)	9.53 (0.375)	22-25	4
10-113474-4S-1-22 <sup>1</sup>	4	41.0 (1.61)	5.80 (0.228)	2.2 (0.087)	3.8 (0.150)	2.5	/
10-113474-4S-1-25	Replaced by 10-113474-4S-1						
10-113474-4S-1-26 <sup>1</sup>	4	41.0 (1.61)	5.80 (0.228)	2.5 (0.098)	3.8 (0.150)	2.5-3.0	12
10-113474-4S-1-30 <sup>1</sup>	4	41.0 (1.61)	5.80 (0.228)	3.0 (0.118)	4.8 (0.189)	4-5	/
10-113474-4S-1-38 <sup>1</sup>	4	41.0 (1.61)	5.80 (0.228)	3.6 (0.142)	6.8 (0.268)	6	10
10-113474-4S-1-50 <sup>1</sup>	4	41.0 (1.61)	5.80 (0.228)	5.0 (0.197)	7.0 (0.276)	10	/
10-113474-4S-1-58 <sup>1</sup>	4	41.0 (1.61)	5.80 (0.228)	5.8 (0.228)	7.8 (0.307)	13.2	6
10-113474-4S-1-62 <sup>1</sup>	4	41.0 (1.61)	5.80 (0.228)	6.2 (0.244)	9.5 (0.374)	16	/
10-113474-1S	0	44.6 (1.76)	9.17 (0.361)	11.5 (0.453)	14.3 (0.563)	50-60	0
10-113474-1S-107 <sup>1</sup>	0	44.6 (1.76)	9.17 (0.361)	10.7 (0.421)	14.35 (0.565)	50	/
10-113474-1S-72 <sup>1</sup>	0	44.6 (1.76)	9.17 (0.361)	7.15 (0.281)	9.5 (0.374)	22-25	4
10-113474-1S-35 <sup>1</sup>	0	44.6 (1.76)	9.17 (0.361)	9.0 (0.354)	14.35 (0.565)	35	/
10-113474-1S-45 <sup>1</sup>	0	44.6 (1.76)	9.17 (0.361)	4.55 (0.179)	6.8 (0.268)	9	8
10-113474-1S-50 <sup>1</sup>	0	44.6 (1.76)	9.17 (0.361)	5.0 (0.197)	7.0 (0.276)	10	/
10-113474-1S-58 <sup>1</sup>	0	44.6 (1.76)	9.17 (0.361)	5.8 (0.228)	7.8 (0.307)	13.2	6
10-113474-1S-62 <sup>1</sup>	0	45.3 (1.78)	9.17 (0.361)	6.2 (0.244)	9.5 (0.374)	16	/
10-113474-0S	4/0	65.9 (2.59)	12.7 (0.500)	16.5 (0.650)	20 (0.787)	107	4/0
10-113474-0S-78 <sup>1</sup>	4/0	65.9 (2.59)	12.7 (0.500)	7.15 (0.281)	9.5 (0.374)	22-25	4
10-113474-0S-107 <sup>1</sup>	4/0	65.9 (2.59)	12.7 (0.500)	10.7 (0.421)	14.35 (0.565)	50	/
10-113474-0S-144 <sup>1</sup>	4/0	65.9 (2.59)	12.7 (0.500)	14.5 (0.571)	20 (0.787)	70	/

**APPLICATION NOTES**

- These contacts accept smaller wire than standard contacts. There may be a sealing issues with grommets. The max current rating is limited by the wire max current rating.
- These contacts accept larger wires than standard contacts. The reduced air/creepage resistance may worsen the service rating and there may be sealing issues with grommets. The max current rating is limited by the contact max current rating. See Page A-33
- Please contact factory for options.
- Please consult our sales department for other contacts or crimp tooling details.

**LouverBand™ Socket Contacts**  
**For Super ITS-MB and Super ITS-RG**

LouverBand™ series contacts are precision-machined using high conductivity copper alloy. A stamped and formed spring (LouverBand) is installed into the socket contact. The spring is made from 6 mil beryllium copper (BeCu). Testing has demonstrated that this contact system outperforms conventional aerospace-grade contact systems. The LouverBand spring provides many points of electrical contact with the mating pin, as opposed to a few “high spots” on

a conventional four-finger contact as shown in Fig 1. The louverband design offers lower voltage drop for reduced temperature rise and higher current carrying capacity. In addition to its electrical advantages, the louverband also is mechanically superior to four-finger contacts. The louverband spring has consistent, stable normal force, even when subjected to thousands of mating cycles and temperature extremes.

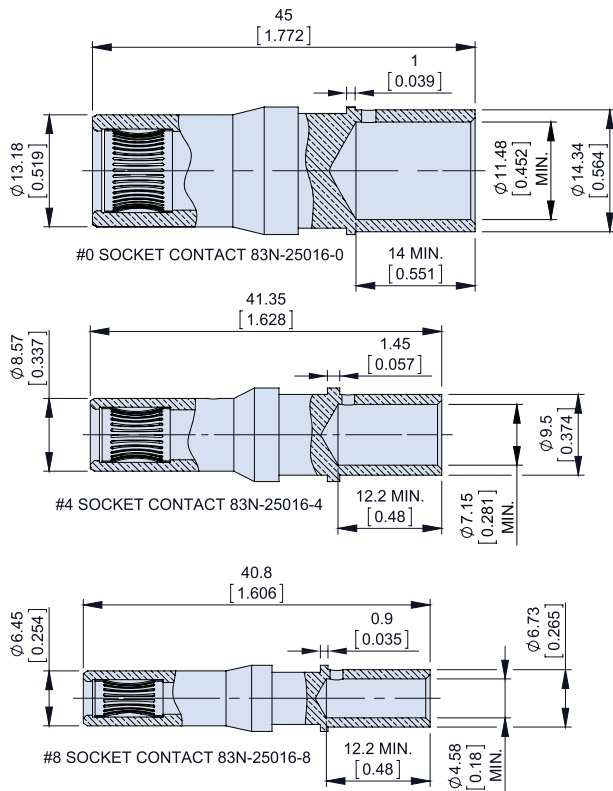

**LouverBand socket contact cutaway**



**Fig. 1**  
**Conventional contact on the left.**  
**LouverBand contact on the right**

Size	Wire Size	Part Number
0	#0	83N-25016-0G10-L
4	#4	83N-25016-4G10-L
8	#8	83N-25016-8G10-L

Contact Size	Current Rating		Contact Resistance (mΩ Max.)	Min Separation Force (ounces) min Diameter SAE-AS31971 pin	Max Average Engagement Force (ounces) Max Diameter SAE-AS31971 pin
	Rated current at +20°C (Ampere)	Rated current at +80°C (Ampere)			
0	300	250	0.2	15	320
4	160	130	0.5	10	240
8	90	70	1	5	160



**ITS Bayonet Contact Reducers  
For Super ITS-MB and Super ITS-RG**

Contact reducers are available for crimp contacts and allow for the installation of smaller wire size into a contact. To install fully insert the reducer into the wire barrel. once fully seated the wire and contact can be fully crimped.



Part Number	Contact Size	From wire size	To wire size
10-869-20A-26AG17	20	AWG 20	AWG 26
10-869-16A-22AG10	16	AWG 16	AWG 22
10-869-16A-20AG10	16	AWG 16	AWG 20
10-869-12A-26AG10	12	AWG 12	AWG 26
10-869-12A-20AG10	12	AWG 12	AWG 20
10-869-12A-16AG10	12	AWG 12	AWG 16
10-869-8A-18AG10	8	AWG 8	AWG 18
10-869-8A-16AG10	8	AWG 8	AWG 16
10-869-8A-14AG10	8	AWG 8	AWG 14
10-869-8A-12AG10	8	AWG 8	AWG 12
10-869-8A-10AG10	8	AWG 8	AWG 10
10-869-8A-2.5MG10	8	AWG 8	2.5 mm2
10-869-8A-6MG10	8	AWG 8	6 mm2
10-869-4A-8AG10	4	AWG 4	AWG 8
10-869-4A-6AG10	4	AWG 4	AWG 6
10-869-4A-16MG10	4	AWG 4	16 mm2
10-869-4A-10MG10	4	AWG 4	10 mm2
10-869-4A-6MG10	4	AWG 4	6 mm2
10-869-4A-2.5MG10	4	AWG 4	2.5 mm2
10-869-0A-6AG10	0	AWG 0	AWG 6
10-869-0A-2AG10	0	AWG 0	AWG 2
10-869-0A-50MG10	0	AWG 0	50 mm2
10-869-0A-35MG10	0	AWG 0	35 mm2
10-869-0A-25MG10	0	AWG 0	25 mm2
10-869-0A-16MG10	0	AWG 0	16 mm2
10-869-0A-10MG10	0	AWG 0	10 mm2
10-869-4/0A-70MG10	4/0	AWG 4/0	70 mm2

Contact reducers allow larger contacts to accept smaller wire than standard. There may be sealing issues with grommets. The max current rating is limited by the wire max current rating.

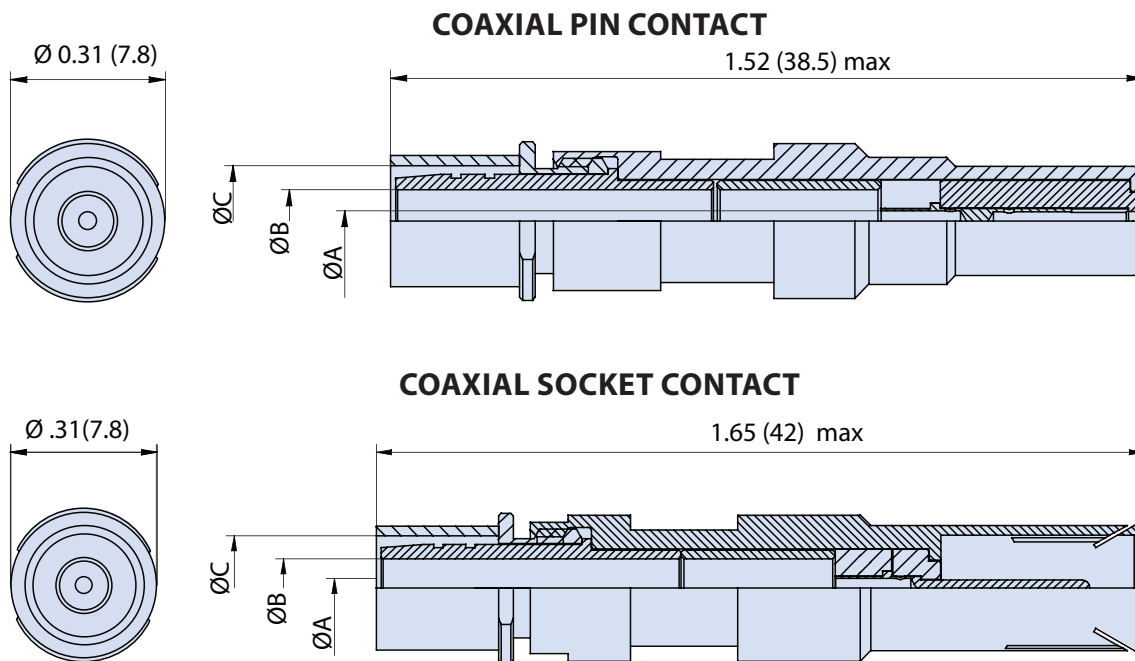

Coaxial Pin and Socket Contact Part Numbers, Cable Information and Dimensions					
Pin P/N	Socket P/N	Used with Cable	Ø A	Ø B	Ø C
CC 70038	CC 70040	RG 58	1.05 (0.04)	3.15 (0.12)	5.23 (0.21)
CC 70046	CC 70042	RG 59	.75 (0.03)	3.90 (0.15)	5.60 (0.22)
CC 70054	CC 70052	RG 179	.55 (0.02)	1.70 (0.07)	3.10 (0.12)
CC 70056	CC 70058	RG 174 / RG 316	.75 (0.03)	1.70 (0.07)	3.10 (0.12)
CC 70060	CC 70062	RG 142	1.05 (0.04)	3.15 (0.12)	5.60 (0.22)
CC 70064	CC 70066	RG 223	1.05 (0.04)	3.15 (0.12)	5.90 (0.23)

**M.118260/C INSERTION AND EXTRACTION TOOL FOR SIZE 8 COAX CONTACTS**



**P/N : M.118260/C**

Insertion and Extraction Tool for COAX Contacts Size 8



**Coaxial Contact Assembly Procedures  
for Super ITS-MB and Super ITS-RG**

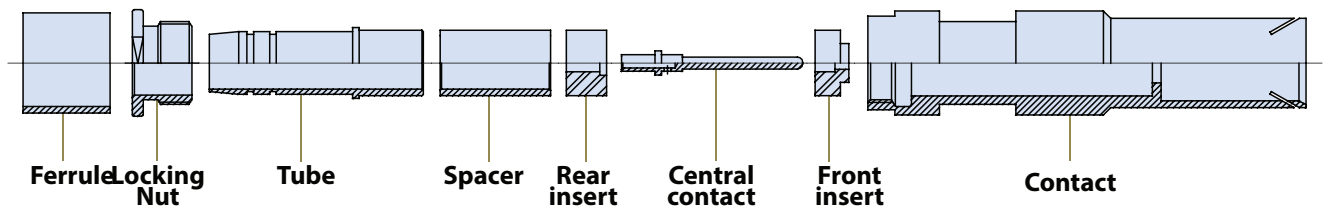

1 – Strip the cable according to the following dimensions

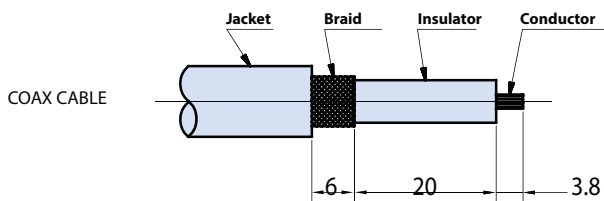

2 – Solder the central contact with the conductor of the coax cable after having pre-tinned the hole of the contact and the conductor, too

3 – Place the ferrule on the braid

4 – Place the locking nut on the tube and then this one on the insulator, then insert the tube under the braid

5 – Crimp the ferrule on the braid using the follow tools:

- Crimping tool: M22520 / 5-01
- Die assy for RG58: M22520 / 5-05 A
- Die assy for RG59: M22520 / 5-45 B
- Die assy for RG142: M22520 / 5-45 B
- Die assy for RG174: M22520 / 5-08 A
- Die assy for RG179: M22520 / 5-08 A
- Die assy for RG223: M22520 / 5-45 A

Note: the nut has to remain free to rotate

6 – Withdraw the spacer on the insulator till it stops against the tube

7 – Place the rear insert on the central contact by the cut on the side

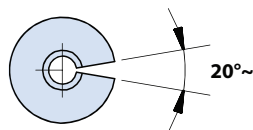

8 – Place the front insert on the central contact and insert everything inside the contact lightly pressing the rear insert; then screw the nut and the contact together.

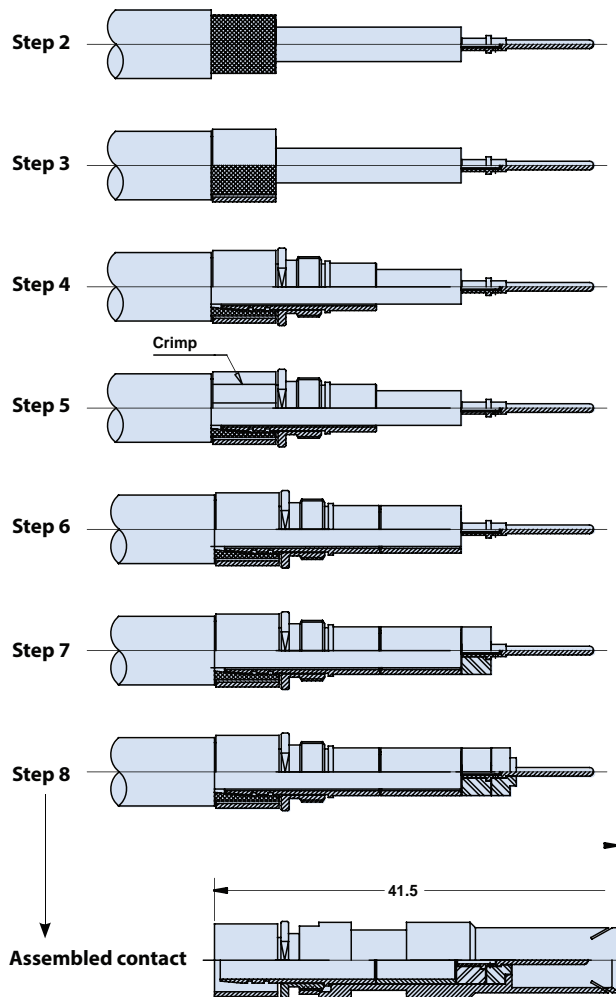

#### PLUG (06) COVER

Stainless Steel Chain (T)

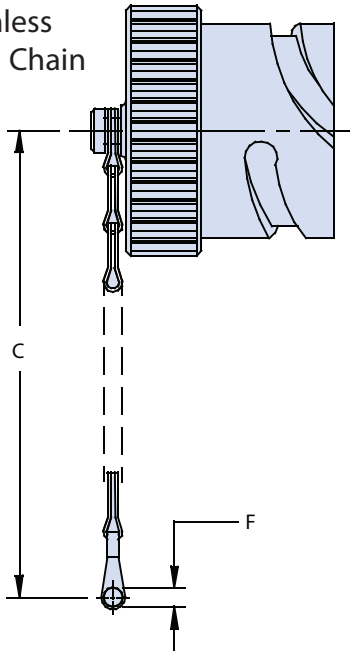

Polyamide Black Rope (KC)

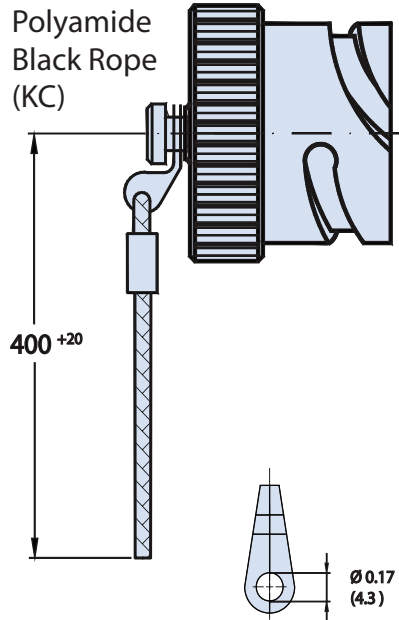

Stainless Steel Wire Rope (TF)

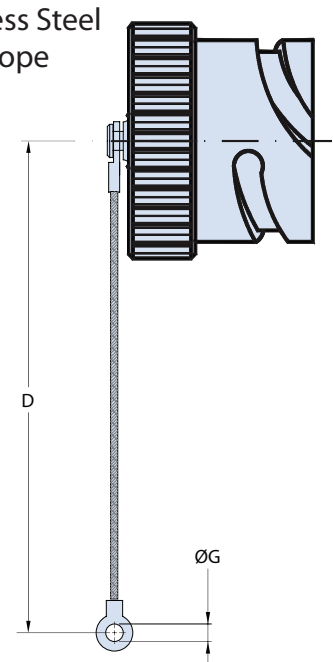

#### Sample Part Number

ITB	06	T	-18	MB
Series	Plug Cover	Lanyard Type	Shell Size	Material and Finish

#### Lanyard Type

Code	Description
T	Stainless Steel Chain
TF	Stainless Steel Wire Rope
KC	Polyamide Black Rope

#### Material and Finish

Code	Material/Finish
MB	Marine Bronze

#### Lanyard Dimensions

Shell Size	SST Chain (Lanyard Type T)		SST Wire Rope (Lanyard Type TF)	
	Std Length (C)	Ring Eyelet Dia (F)	Std Length (D)	Ring Eyelet Dia (G)
10SL	108 (4.25)	4.3 (0.17)	193 (7.60)	4.3 (0.17)
14S	123 (4.84)	4.3 (0.17)	193 (7.60)	4.3 (0.17)
16S	123 (4.84)	4.3 (0.17)	193 (7.60)	4.3 (0.17)
16	123 (4.84)	4.3 (0.17)	193 (7.60)	4.3 (0.17)
18	123 (4.84)	4.3 (0.17)	193 (7.60)	4.3 (0.17)
20	138 (5.43)	4.8 (0.19)	193 (7.60)	4.3 (0.17)
22	138 (5.43)	4.8 (0.19)	193 (7.60)	4.3 (0.17)
24	138 (5.43)	4.8 (0.19)	193 (7.60)	4.3 (0.17)
28	206 (8.11)	4.8 (0.19)	193 (7.60)	5.3 (0.21)
32	206 (8.11)	5.6 (0.22)	193 (7.60)	5.3 (0.21)
36	206 (8.11)	5.6 (0.22)	193 (7.60)	5.3 (0.21)
40	206 (8.11)	5.6 (0.22)	193 (7.60)	5.3 (0.21)

**WALL MOUNT (02) RECEPTACLE COVER**

Stainless Steel Chain (T)

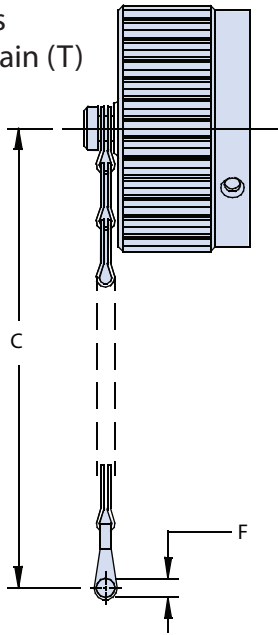

Polyamide Black Rope (KA)

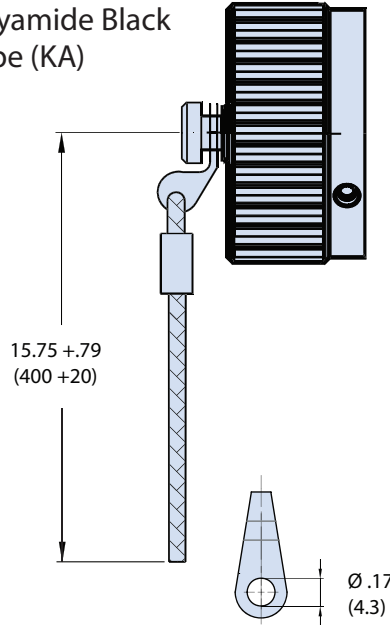

Stainless Steel Wire Rope (TF)

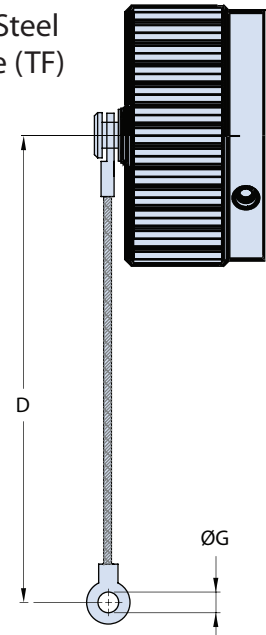

Sample Part Number				
ITB	02	T	-18	MB
Series	Shell Style Cover Type	Lanyard Type	Shell Size	Material and Finish

Lanyard Type	
Code	Description
T	Stainless Steel Chain
TF	Stainless Steel Wire Rope
KA	Polyamide Black Rope

Material and Finish	
Code	Material / Finish
MB	Marine Bronze

Lanyard Dimensions				
Shell Size	SST Chain (Lanyard Type T)		SST Wire Rope (Lanyard Type TF)	
	Std Length (C)	Ring Eyelet Dia (F)	Std Length (D)	Ring Eyelet Dia (G)
10SL	108 (4.25)	109.22 (4.30)	193 (7.60)	4.3 (0.17)
14S	108 (4.25)	109.22 (4.30)	193 (7.60)	4.3 (0.17)
16S	108 (4.25)	109.22 (4.30)	193 (7.60)	4.3 (0.17)
16	123 (4.84)	109.22 (4.30)	193 (7.60)	4.3 (0.17)
18	123 (4.84)	109.22 (4.30)	193 (7.60)	4.3 (0.17)
20	123 (4.84)	109.22 (4.30)	193 (7.60)	4.3 (0.17)
22	123 (4.84)	109.22 (4.30)	193 (7.60)	4.3 (0.17)
24	123 (4.84)	109.22 (4.30)	193 (7.60)	4.3 (0.17)
28	206 (8.11)	142.24 (5.60)	193 (7.60)	5.3 (0.21)
32	206 (8.11)	142.24 (5.60)	193 (7.60)	5.3 (0.21)
36	206 (8.11)	142.24 (5.60)	193 (7.60)	5.3 (0.21)
40	206 (8.11)	142.24 (5.60)	193 (7.60)	5.3 (0.21)

#### JAM-NUT (07) RECEPTACLE COVER

Stainless Steel Chain (T)

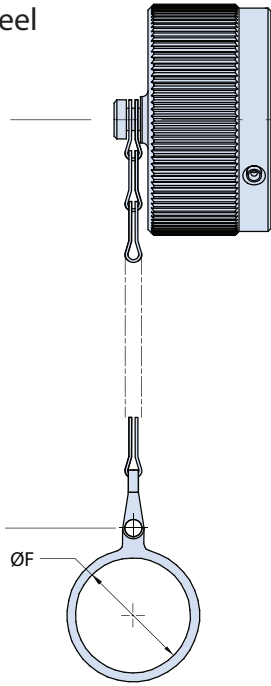

Polyamide Black Rope (TFN)

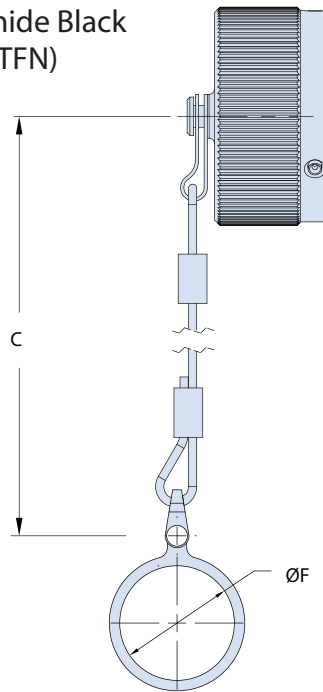

Stainless Steel Wire Rope (TF)

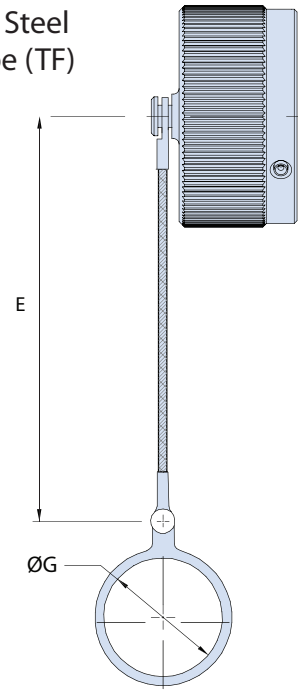

Sample Part Number				
ITB	07	T	-18	MB
Series	Basic P/N	Lanyard Type	Shell Size	Material and Finish

Lanyard Type	
Code	Description
T	Stainless Steel Chain
TF	Stainless Steel Wire Rope
TFN	Polyamide Black Rope

Material and Finish	
Code	Material / Finish
MB	Marine Bronze

Lanyard Dimensions				
Shell Size	SST Chain (Lanyard Type T)		SST Wire Rope (Lanyard Type TF)	
	Std Length (C)	Ring Eyelet Dia (F)	Std Length (D)	Ring Eyelet Dia (G)
10SL	119 (4.69)	22.65 (0.89)	208 (8.19)	22.65 (0.89)
14S	121 (4.76)	29.00 (1.14)	208 (8.19)	29.00 (1.14)
16S	121 (4.76)	32.15 (1.27)	208 (8.19)	32.15 (1.27)
16	137 (5.39)	32.15 (1.27)	208 (8.19)	32.15 (1.27)
18	138 (5.43)	35.35 (1.39)	208 (8.19)	35.35 (1.39)
20	138 (5.43)	38.50 (1.52)	208 (8.19)	38.50 (1.52)
22	138 (5.43)	41.00 (1.61)	208 (8.19)	41.00 (1.61)
24	138 (5.43)	44.70 (1.76)*	208 (8.19)	45.00 (1.77)*
28	138 (5.43)	51.20 (2.02)*	208 (8.19)	51.20 (2.02)*
32	221 (8.70)	57.50 (2.26)*	208 (8.19)	57.50 (2.26)*
36	221 (8.70)	63.80 (2.51)*	208 (8.19)	63.80 (2.51)*
40	221 (8.70)	70.20 (2.76)*	208 (8.19)	70.20 (2.76)*

\* Please contact the factory

**ITS-MB OR IGE-MB FRONT PANEL MOUNT DUMMY STORAGE RECEPTACLE FOR PLUG**

Sample Part Number			
<b>ITS</b>	<b>05</b>	<b>-32</b>	<b>MB</b>
Series	Basic P/N	Shell Size	Material and Finish

Series and Shell Sizes Available	
Series	Shell Sizes
<b>ITS</b>	10SL, 14S, 16S, 16, 18, 20, 22, 24, 28, 32, 36, 40
<b>IGE</b>	16, 18, 22, 28, 32

Material and Finish	
Code	Material / Finish
<b>MB</b>	Marine Bronze/Unplated

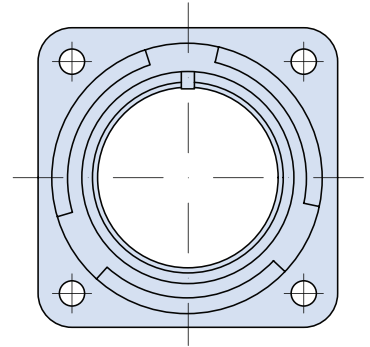
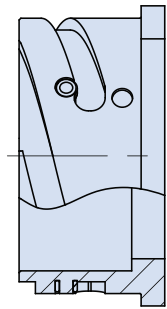

Dummy receptacle storage fitting protects the plug connector when not in use.

**ITS-MB OR IGE-MB REAR PANEL MOUNT DUMMY STORAGE RECEPTACLE FOR PLUG**

Sample Part Number			
<b>ITS</b>	<b>050</b>	<b>-32</b>	<b>MB</b>
Series	Basic P/N	Shell Size	Material and Finish

Series and Shell Sizes Available	
Series	Shell Sizes
<b>ITS</b>	10SL, 14S, 16S, 16, 18, 20, 22, 24, 28, 32, 36, 40
<b>IGE</b>	16, 18, 22, 28, 32

Material and Finish	
Code	Material / Finish
<b>MB</b>	Marine Bronze/Unplated

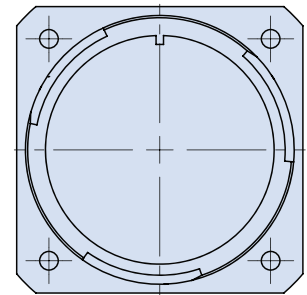
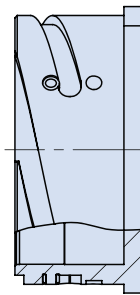

Dummy receptacle storage fitting protects the plug connector when not in use.

#### IT 3057 CLASS A CABLE CLAMP

Sample Part Number				
IT	3057	-16	A	MB
Series	Basic P/N	Shell Size Code	Class Code	Material and Finish

Part Number	Shell Size	Sleeve Part No.	ØB	F Thread
IT 3057-10A	18	IT 3420-10	16.0 (0.63)	1.0000 - 20UNEF
IT 3057-12A	20-22	IT 3420-12	19.0 (0.75)	1.1875 - 18UNEF
IT 3057-16A	24-28	IT 3420-16	23.8 (0.94)	1.4375 - 18UNEF
IT 3057-20A	32	IT 3420-20	31.7 (1.25)	1.7500 - 18UNS
IT 3057-24A	36	IT 3420-24	35.0 (1.38)	2.0000 - 18UNS
IT 3057-28A	40	IT 3420-28	41.2 (1.62)	2.2500 - 16UN

Material and Finish	
MB	Marine Bronze/Unplated

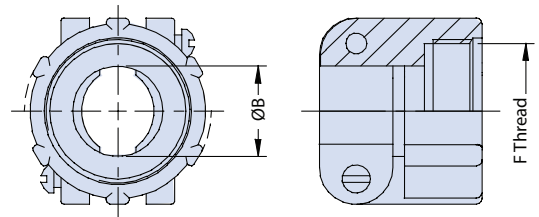

#### IT 3057, CLASS C CABLE CLAMP

Sample Part Number				
IT	3057	-18	C	MB
Series	Basic P/N	Shell Size Code	Class Code	Material and Finish

Part Number	Shell Size	Sleeve to Use	ØB		F Thread
			min.	Max.	
IT 3057-10C	18	IT 3420 - 6A / 10A	9.60 (0.378)	15.87 (0.625)	1.0000 - 20UNEF
IT 3057-12C	20-22	IT 3420 - 8A / 12A	11.30 (0.445)	19.00 (0.748)	1.1875 - 18UNEF
IT 3057-16C	24-28	IT 3420 - 8A / 12A / 16A	15.50 (0.610)	23.80 (0.937)	1.4375 - 18UNEF
IT 3057-20C	32	IT 3420 - 12A / 16A / 20A	23.40 (0.921)	31.75 (1.250)	1.7500 - 18UNS
IT 3057-24C	36	IT 3420 - 16A / 18A / 24A	23.40 (0.921)	35.00 (1.378)	2.0000 - 18UNS
IT 3057-28C	40	IT 3420 - 16A / 20A / 28A	29.90 (1.177)	41.25 (1.624)	2.2500 - 16UN

Material and Finish	
MB	Marine Bronze/Unplated

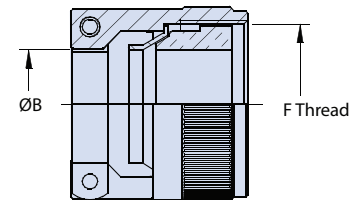

#### NEOPRENE SLEEVE FOR CLASS A CABLE CLAMPS

Part Number	ØC
IT 3420 - 10	14.3 (0.56)
IT 3420 - 12	15.9 (0.63)
IT 3420 - 16	19.1 (0.75)
IT 3420 - 20	23.8 (0.94)
IT 3420 - 24	31.8 (1.25)
IT 3420 - 28	34.9 (1.37)

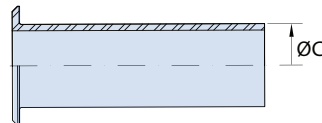

#### NEOPRENE SLEEVE FOR CLASS C CABLE CLAMPS

Part Number	ØC
IT 3420 - 6A	10.8 (0.43)
IT 3420 - 8A	13.5 (0.53)
IT 3420 - 10A	15.6 (0.61)
IT 3420 - 12A	18.8 (0.74)
IT 3420 - 16A	23.5 (0.93)
IT 3420 - 20A	31.5 (1.24)
IT 3420 - 24A	34.7 (1.37)
IT 3420 - 28A	41.0 (1.61)

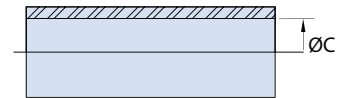

Sample Part Number	
IT 3420	10
Series	Shell Size

Sample Part Number	
IT 3420	6A
Series	Shell Size

**IT 40450 FRONT PANEL MOUNT. WALL MOUNT RECEPTACLE GASKET**

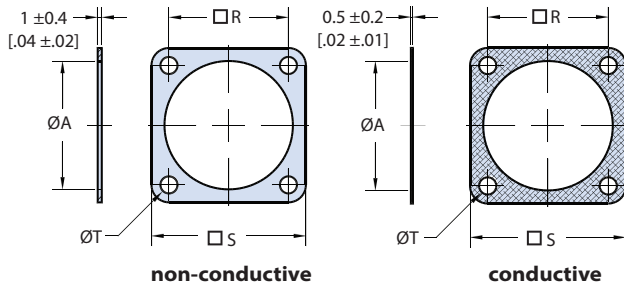

**IT 40460 REAR PANEL MOUNT. WALL MOUNT RECEPTACLE GASKET**

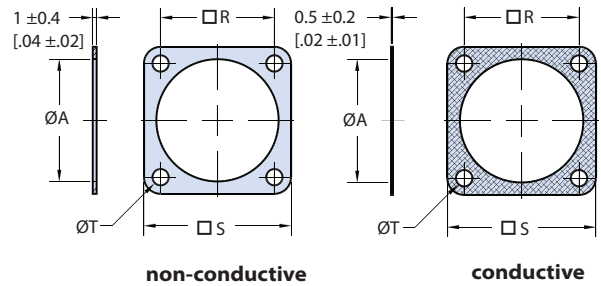

Sample Part Number			
<b>ITB</b>	<b>40450</b>	<b>-18</b>	<b>V</b>
Series	Basic P/N	Shell Size	Material

Sample Part Number			
<b>ITB</b>	<b>40460</b>	<b>-18</b>	<b>S</b>
Series	Basic P/N	Shell Size	Material

Dimensions					
Part No./ Shell Size	Shell Size Ref	ØA +1	R ±0.2	S ±0.5	ØT +0.5
IT40450-10	10SL	15.7 (0.62)	18.2 (0.72)	25.4 (1.00)	4.2 (0.17)
IT40450-14	14S	22.1 (0.87)	23.0 (0.91)	30.0 (1.18)	4.2 (0.17)
IT40450-16	16S-16	25.3 (1.00)	24.6 (0.97)	32.5 (1.28)	4.2 (0.17)
IT40450-18	18	28.4 (1.12)	27.0 (1.06)	35.0 (1.38)	4.2 (0.17)
IT40450-20	20	31.6 (1.24)	29.4 (1.16)	38.0 (1.50)	4.2 (0.17)
IT40450-22	22	34.8 (1.37)	31.8 (1.25)	41.0 (1.61)	4.2 (0.17)
IT40450-24	24	38.0 (1.50)	34.9 (1.37)	44.5 (1.75)	4.2 (0.17)
IT40450-28	28	44.3 (1.74)	39.7 (1.56)	50.8 (2.00)	5.1 (0.20)
IT40450-32	32	50.7 (2.00)	44.5 (1.75)	57.0 (2.24)	5.1 (0.20)
IT40450-36	36	57.0 (2.24)	49.2 (1.94)	63.5 (2.50)	5.1 (0.20)
IT40450-40	40	62.5 (2.46)	55.5 (2.19)	69.9 (2.75)	5.1 (0.20)

Dimensions					
Part No./ Shell Size	Shell Size Ref	ØA +1	R ±0.2	S ±0.5	ØT +0.5
IT40460-10	10SL	15.7 (0.62)	18.2 (0.72)	25.4 (1.00)	4.2 (0.17)
IT40460-14	14S	22.1 (0.87)	23.0 (0.91)	30.0 (1.18)	4.2 (0.17)
IT40460-16	16S-16	25.3 (1.00)	24.6 (0.97)	32.5 (1.28)	4.2 (0.17)
IT40460-18	18	28.4 (1.12)	27.0 (1.06)	35.0 (1.38)	4.2 (0.17)
IT40460-20	20	31.6 (1.24)	29.4 (1.16)	38.0 (1.50)	4.2 (0.17)
IT40460-22	22	34.8 (1.37)	31.8 (1.25)	41.0 (1.61)	4.2 (0.17)
IT40460-24	24	38.0 (1.50)	34.9 (1.37)	44.5 (1.75)	4.2 (0.17)
IT40460-28	28	44.3 (1.74)	39.7 (1.56)	50.8 (2.00)	5.1 (0.20)
IT40460-32	32	50.7 (2.00)	44.5 (1.75)	57.0 (2.24)	5.1 (0.20)
IT40460-36	36	57.0 (2.24)	49.2 (1.94)	63.5 (2.50)	5.1 (0.20)
IT40460-40	40	62.5 (2.46)	55.5 (2.19)	69.9 (2.75)	5.1 (0.20)

Material	
Sym	Description
Omit for Neoprene	
<b>S</b>	Conductive; Wire Mesh in Neoprene Substrate
<b>F</b>	Fluorosilicone
<b>V</b>	Viton
<b>Y</b>	Silicone

Material	
Sym	Description
Omit for Neoprene	
<b>S</b>	Conductive; Wire Mesh in Neoprene Substrate
<b>F</b>	Fluorosilicone
<b>V</b>	Viton
<b>Y</b>	Silicone

**IT-305045 WIRE HOLE PLUG FOR CONTACT INSERTS**

Part Number	Contact Size	Color
10-305045-16	16S - 16	Blue
10-101033-13	12	Yellow
10-305045-8	8	White
10-305045-4	4	Green
10-305045-0	0	Black
10-305045-01	0M	Black

**APPLICATION NOTES**

1. Contact Hole Plug - Insert Version.
2. Used to fill an insert cavity in order to maintain the environmental seal when a cavity is without contact



**10-305045-16**

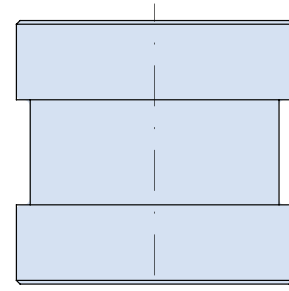

**10-101033-13 thru 01**

**IT-101033 WIRE HOLE PLUG FOR CONTACT INSERTS**

Part Number	Contact Size	Color
10-101033-12	16S - 16	Blue
10-101033-13	12	Yellow
10-101033-14	8	White
10-101033-15	4	Green
10-101033-16	0	Black

**APPLICATION NOTES**

1. Contact Hole Plug - Insert Version.
2. Used to fill an insert cavity in order to maintain the environmental seal when a cavity is without contact

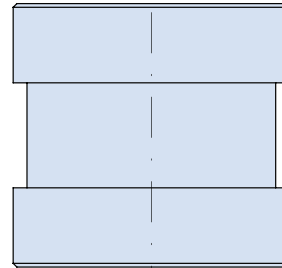

**10-101033-XX**





ISO/IEC 17025

# BLQ ENV-Test: IEC Qualified Laboratory, Inspection, and Measurement Services

ISO 9001 and EN 9100 registered; comprehensive test plans, reports, and documentation IAW customer requirements

**E**nvironmental testing, consisting of the complete range of mechanical, electrical and environmental stress factors that affect electronic equipment, cabling, and systems is now available from BLQ ENV-Test, Glenair’s IEC/IECQ certified independent testing laboratory, offering accelerated lead times—from initial quoting to final test report delivery.

<b>Electrical</b>	Insulation · High Voltage Dielectric Test · Resistance Current · Partial Discharge · EMC Shielding
<b>Ethernet/Optic</b>	Ethernet Certification · Optical Insertion Loss / Return Loss Photonic / Color / Lux Intensity Measurement
<b>Environmental</b>	Heat · Cold · Thermal Shock · Humidity · Ice · Salt Spray Low Pressure · Fluid Test · Seal and Pressure
<b>Mechanical / Dynamics</b>	Vibration · Mechanical Shock · Compression Force Tensile Strength · Torque Force · Release Mechanism Test
<b>Leakage</b>	Oil Leakage · Air Leakage · Helium Leakage Watertightness IP67 and IP68
<b>Metrology and Dimensional</b>	Dimensional · Profile Measurement · Thread Measurement Hardness Testing · Roughness Measurement
<b>Rubber and Plastic Materials</b>	Density Measurement · Compression Set · FTIR · Hardness Elongation at Break · Tensile Strength · Dielectric Breakdown
<b>Plating</b>	Elemental Composition of the Plating Metallographic Section Plating Adhesion and Corrosion · X-Ray Measurement
<b>Harnessing</b>	Automatic Test of Insulation · Resistance Dielectric Withstanding Voltage

- Mechanical / dynamic testing for both electrical and fiber optic components, subsystems, and wiring harnesses
- Automatic testing of harnessing with scientific root cause analysis
- Fast turnaround on quotes and testing services
- Decades of experience
- Unique expertise in high-voltage (partial discharge) testing
- Professionally prepared test reports supplied for every project
- Ample in-house resources for both small and large-scale equipment test plans



# Electrical Tests

## ELECTRICAL / EMC TESTING

CONTACT RESISTANCE	APPLICABLE STANDARD
Minimum res. 1 $\mu\Omega$	ISO/IEC 17025 Accredited test: BS EN / IEC 60512-2-1 ; BS EN / IEC 60512-2-2
	Standard which we are specialist: EIA-364-06; EIA-364-23; SAE AS39029; VG95234; VG95328; VG96929; VG95351; VG96934; VG95319-2; MIL-DTL-26482; MIL-DTL-38999; AFNOR NF F 61-030
INSULATION RESISTANCE & INSULATION RESISTANCE AT HIGH TEMPERATURE	APPLICABLE STANDARD
1 - 1500 VDC ; 100 $\Omega$ - 2000 T $\Omega$	ISO/IEC 17025 Accredited test: BS EN / IEC 60512-3-1
Up to 260°C	Standard which we are specialist: EIA-364-21; VG95234; VG95328; VG96929; VG95351; VG96934; VG95319-2; MIL-DTL-26482; MIL-DTL-38999; SAE AS 50151; AFNOR NF F 61-030; MIL-DTL-38999; MIL-DTL-26482
DIELECTRIC WITHSTANDING VOLTAGE SEA LEVEL & ALTITUDE	APPLICABLE STANDARD
AC Voltage 50 Hz - 60Hz : 0 - 50 KVAC ; Max I. Leak: 300mA	ISO/IEC 17025 Accredited test: BS EN / IEC 60512-3-1
DC Voltage: 1 - 1500 VDC	Standard which we are specialist: EIA-364-21; VG95328; VG96929; VG95351; VG96934; VG95234; VG95319-2; EIA-364-20; MIL-DTL-26482; MIL-DTL-38999; AFNOR NF F 61-030
Pressure 5mBar	
CURRENT TEMPERATURE RISE AND CURRENT DE-RATING	APPLICABLE STANDARD
DC Current : 0 - 2000 Ampere	ISO/IEC 17025 Accredited test: BS EN / IEC 60512-5-1 ; BS EN / IEC 60512-5-2
	Standard which we are specialist: AFNOR NF F 61-030; VG95328; VG96929; VG95319-2; VG95234; EIA-364-70
PARTIAL DISCHARGE	SPECIFICATION APPLICABLE
AC Voltage 50 Hz - 60Hz : 0 - 50 KVAC ; Max I. Leak: 300mA	Standard which we are specialist: ASTM D 1868-07; IEC 60270; EN 2591-227
PD event time resolution: < 2 ns	
Minimum PD level: 4 pC	
Center frequency 0 Hz $\pm$ 32 MHz	
Frequency domain bandwidth: 9 kHz, 40 kHz, 100 kHz, 160 kHz, 300kHz, 650kHz, 1MHz, 1.5MHz	
HOUSING / SHELL-TO-SHELL CONDUCTIVITY	SPECIFICATION APPLICABLE
Resolution: 0,001mV	ISO/IEC 17025 Accredited test: BS EN / IEC 60512-2-6
	Standard which we are specialist: EIA-364-83; MIL-DTL-26482; MIL-DTL-38999; VG95234; VG95328; VG96929; VG95351; VG96934; VG95319-2
EMC-EMI	APPLICABLE STANDARD
Shielding effectiveness	ISO/IEC 17025 Accredited test: BS EN / IEC 62153-4-7
Ti axial Method	Standard which we are specialist: VG95328; VG96929; VG96934; VG95319-2; VG95234; MIL-DTL-26482; MIL-DTL-38999
9 kHz - 2,6 GHz ; 90dB max.	
MAGNETIC PERMEABILITY	SPECIFICATION APPLICABLE
1.5 $\mu$ ; 2.0 $\mu$ ; 2.5 $\mu$	Standard which we are specialist: EIA-364-54; ASTM A342/A342M; MIL-DTL-26482; MIL-DTL-38999

**Electrical / EMC Testing services** cover the complete range of performance requirements for interconnect cabling and electronic components. Glenair brings years of EMC design engineering experience into the testing process, ensuring equipment under test is always correctly fixtured and prepared for the most accurate results.

### Available Tests:

- Contact resistance
- Dielectric withstanding voltage (DWV)
- Current rating
- Insulation resistance
- EMC shielding
- Partial discharge

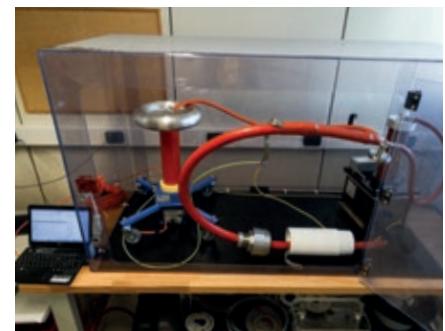

**ETHERNET / OPTICAL FIBER / HIGH SPEED DATA**



ETHERNET	SPECIFICATION APPLICABLE
Up to CAT. Fa	Standard which we are specialist: CEI EN 50173; TIA/EIA 568; ISO/IEC 11801

OPTICAL FIBER - INSERTION LOSS	SPECIFICATION APPLICABLE
850/1300/1310/1550 nm; Res. 0,01dB	Standard which we are specialist: TIA/EIA-455-34; MIL-PRF-28776

OPTICAL FIBER - RETURN LOSS	SPECIFICATION APPLICABLE
850/1300/1310/1550 nm	Standard which we are specialist: TIA/EIA-455-107; MIL-PRF-28776

**PHOTONIC / OPTICAL TESTS**

Light measurement, to measure the main luminous features of our lighting products for railways, such as headlights, taillights, traffic lights, and other onboard or trackside lighting devices.

Inside this dark room we are able to measure luminous flux (lumen), luminous intensity (candle), chromatic coordinates

(X,Y), color rendering index (CRI), color temperature (CCT), the spectral chart and the angular distribution of the light.

Our fixed equipment measures features inside our dark room, and our small portable device makes measurements in remote locations.

PHOTONIC TESTS	SPECIFICATION APPLICABLE
Flux, Lumen: 10 - 50,000; Intensity, candela: 10 - 50,000; Color Temperature: 1,000 - 10,000 K; CRI Index: 0 - 100	Standard which we are specialist: CEI EN 60598-1

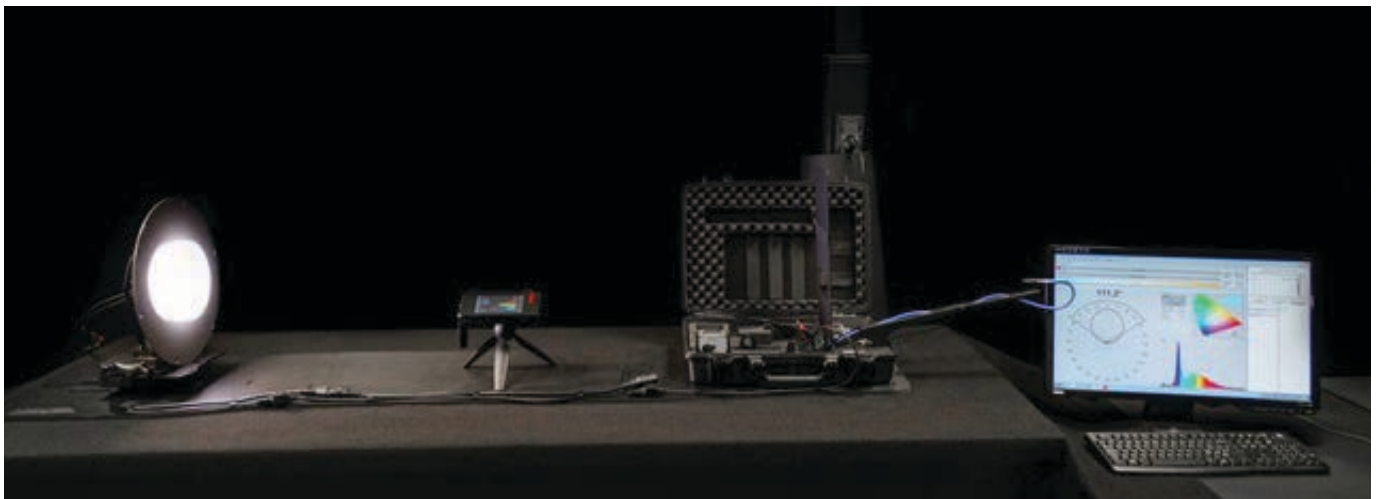



## Environmental Tests

### TEMPERATURE / HUMIDITY TESTING

DAMP HEAT STEADY STATE	APPLICABLE STANDARD
Temp. Range : +10°C to +90°C	ISO/IEC 17025 Accredited test: BS EN / IEC 60068-2-3  Standard which we are specialist: EIA-364-31; AFNOR NF F 61-030; VG95328; VG96929; VG95351; VG96934; VG95319-2; VG95234; MIL-DTL-38999; MIL-DTL-26482
Humidity Range : 10 to 98%rh	
Chamber Size:	
690mmx600mmx610mm 500mmx610mmx500mm	

DAMP HEAT-CYCLIC	APPLICABLE STANDARD
Temp. Range : +10°C to +90°C (with humidity) ; -40°C to 180°C	ISO/IEC 17025 Accredited test: BS EN / IEC 60068-2-30  Standard which we are specialist: EIA-364-31; AFNOR NF F 61-030; VG95328; VG96929; VG95351; VG96934; VG95319-2; VG95234; MIL-DTL-38999; MIL-DTL-26482
Humidity Range : 10 to 98%rh	
Chamber Size :	
650mmx500mmx600mm 800mmx600mmx500mm	

COLD	APPLICABLE STANDARD
Min Temp : -65°C	ISO/IEC 17025 Accredited test: BS EN / IEC 60068-2-1  Standard which we are specialist: EIA-364-59 ; VG95234; VG95328; VG96929; VG95351; VG96934; VG95319-2
Max chamber size :	
800mmx600mmx500mm	

ICE RESISTANCE	APPLICABLE STANDARD
Min Temp : -65°C	Standard which we are specialist: MIL-DTL-38999
Max chamber size :	
800mmx600mmx500mm	

Temperature and Humidity Testing is performed using industry-standard and IEC accepted practices of temperature cycling and humidity exposure. New and high-quality testing equipment ensures accurate results.

#### Available Tests:

- Dry heat
- Dry cold
- Damp heat steady state
- Damp heat cyclic
- Thermal shock



**Environmental Test**

**CORROSION / FLUID**

DRY HEAT - TEMPERATURE LIFE TEST	APPLICABLE STANDARD
Maximum Temp : +260°C	ISO/IEC 17025 Accredited test: BS EN / IEC 60068-2-2
Chamber Size :	Standard which we are specialist: EIA-364-17; VG95234; VG95328; VG96929; VG95351; VG96934; VG95319-2; MIL-DTL-26482; MIL-DTL-38999; AFNOR NF F 61-030
500mmx600mmx600mm	
THERMAL SHOCK / TEMPERATURE CYCLING	APPLICABLE STANDARD
Temp. Range : -65°C to +260°C	ISO/IEC 17025 Accredited test: BS EN / IEC 60068-2-14
Manual (two chambers method)	Standard which we are specialist: EIA-364-32; VG95234; VG95328; VG96929; VG95351; VG96934; VG95319-2; MIL-DTL-26482; MIL-DTL-38999; AFNOR NF F 61-030
CHANGE OF TEMPERATURE	APPLICABLE STANDARD
Gradual in air; -75°C / +180°C ; -75°C to +180°C: 5°C/Min ; +180°C to -75°C: 2,5°C/Min	ISO/IEC 17025 Accredited test: BS EN / IEC 60068-2-14
LOW PRESSURE / ALTITUDE / ALTITUDE IMMERSION	APPLICABLE STANDARD
Sea level to 5mBar ; up to 200°C	Standard which we are specialist: EIA-364-03; MIL-DTL-26482; VG95234; VG95328; VG96929; VG95319-2.
SALT SPRAY / CORROSION TEST	APPLICABLE STANDARD
Max chamber size : 500 Lt	ISO/IEC 17025 Accredited test: BS EN / IEC 60068-2-11
Salt spray static, cyclic (salt spray + humidity), dynamic (salt spray + durability)	Standard which we are specialist: IEC 60068-2-52; ASTM B117-11; ISO 9227; ASTM D1654 - 92; AFNOR NF F 61-030; EIA-364-26; VG95234; VG95328; VG96929; VG95351; VG96934; VG95319-2; MIL-DTL-26482; MIL-DTL-38999
FLUID RESISTANCE	APPLICABLE STANDARD
Testing & evaluation of materials to fluid.	Standard which we are specialist: EIA-364-10; MIL-DTL-38999; MIL-DTL-26482; VG95234; VG95328; VG96929; VG95351; VG96934; VG95319-2; MIL-DTL-38999; MIL-DTL-26482; AFNOR NF F 61-030

Accelerated harsh-weather testing is performed to ensure components under test meet qualification requirements for galvanic corrosion and resistance, resistance to solvents, and SO2.

**Available Tests:**

- Salt spray/SO2
- Resistance to solvents



**MECHANICAL / DYNAMIC TESTING / LEAKAGE**

VIBRATION - SINUSOIDAL	APPLICABLE STANDARD
Freq. Range: 5 to 2000 Hz Peak thrust: 8,90kN (30G max. up to 5Kg.sample) Max pk/pk displacement: 50mm Ambient temperature	ISO/IEC 17025 Accredited test: BS EN / IEC CEI EN 60068-2-6  Standard which we are specialist: EIA-364-28; VG95351; VG96934; VG95319-2; MIL-DTL-26482; AFNOR NF F 61-030
VIBRATION - RANDOM	APPLICABLE STANDARD
Freq. Range: 5 to 2000 Hz Peak thrust: 5,76kN (25G max. up to 5Kg.sample) Max pk/pk displacement: 50mm	ISO/IEC 17025 Accredited test: BS EN / IEC CEI EN 60068-2-64  Standard which we are specialist: EIA-364-28; VG95234; VG95328; VG96929; VG95319-2; MIL-DTL-26482; EN 61373; AFNOR NF F 61-030
SHOCK - BUMP	APPLICABLE STANDARD
(Half sine, Sawtooth, and Trapezoidal waveforms) Peak thrust: 17,36kN (100G max. up to 5Kg.sample) Max pk/pk displacement: 50mm	ISO/IEC 17025 Accredited test: BS EN / IEC CEI EN 60068-2-27 ; BS EN / IEC CEI EN 60068-2-29  Standard which we are specialist: EIA-364-27; VG95234; VG95328; VG96929; VG95351; VG96934; VG95319-2; CEI EN 61373; MIL-DTL-26482
DISCONTINUITY MEASUREMENT DURING VIBRATION	APPLICABLE STANDARD
Measurement of electrical discontinuity (up to 0,1µs) or fiber optic insertion loss	Standard which we are specialist: EIA-364-28
AXIAL FORCE (compression and tensile)	APPLICABLE STANDARD
Force: 0,05 N to 10KN  Example - Insert test: Contact Retention; Contact insertion and removal forces; Maintenance aging; Insert Retention; Gage location and retention; Insertion and removal tool abuse; Installing/removal tool abuse; Probe Damage; Insert bond strength; Insert grommet bonding; Retention of the insulation in the casing;	Standard which we are specialist: EIA-364-05; EIA-364-24; EIA-364-35; EIA-364-25; EIA-364-29; VG95328; VG96929; VG95319-2; VG95234; MIL-DTL-26482; MIL-DTL-38999; MIL-DTL-26482; MIL-DTL-38999; AFNOR NF 61-030
Example -Contact & crimp test: Contact engaging and separating forces; Withdrawal force of the individual contact; Tensile Strength: Crimp tensile strength; Pull Out force; Tensile force	SAE AS39029; EIA-364-29; MIL-DTL-26482; VG95328; VG96929; VG95319-2; VG95234; EIA-364-08.
Example - External bending moment - Crush	MIL-DTL-26482; AS95234; SAE AS5015; MIL-DTL-38999
TORQUE FORCE	APPLICABLE STANDARD
Force: 0,1 Nm to 100 Nm  Example: Mating - Un-mating force ; Coupling and uncoupling torque	Standard which we are specialist: EIA-364-13; EIA-364-114; MIL-DTL-26482; MIL-DTL-38999; VG95328; VG96929; VG95351; VG96934; VG95319-2; VG95234; AFNOR NF F 61-030
RELEASE MECHANISM MACHINE	APPLICABLE STANDARD
Acceleration: 3m/s <sup>2</sup>  Lanyard: Pull-separation; Fail-safe disengagement	Standard which we are specialist: MIL-DTL-38999/31
LEAKAGE TEST	APPLICABLE STANDARD
Watertightness (up to 50BAR)  Oil Leakage (up to Up to 150 Bar)	Standard which we are specialist: VG95234; VG95328; VG96929; VG95351; VG96934; VG95319-2; IEC 60068-2-17; EN 60529 IPX7-IPX8; MIL-DTL-26482
Air Leakage (up to 4 Bar)	Standard which we are specialist: EIA-364-02; VG95328; MIL-DTL-26482 ; DIN EN 60068-2-17 Qa
Helium leakage	Standard which we are specialist: MIL-STD-202 TEST METHOD 112; IEC60068-2-17 QK
MISCELLANEOUS	
Visual & Dimensional evaluation - Crimp: Examination on wired samples - durability - Impact - Marking Test - Solderability	

Controlled vibration and shock testing ensures electrical and electronic components can withstand specified forms of dynamic stress encountered during operation and shipping.

**Available Tests:**

- Vibration sine
- Vibration random
- Bump
- Shock

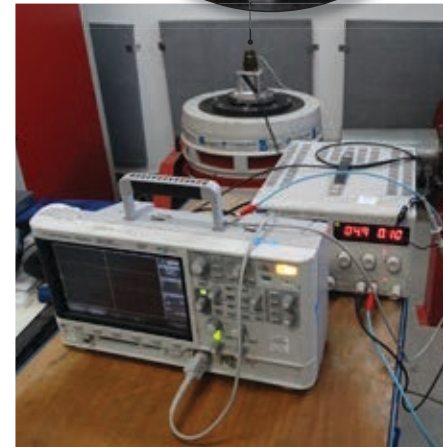
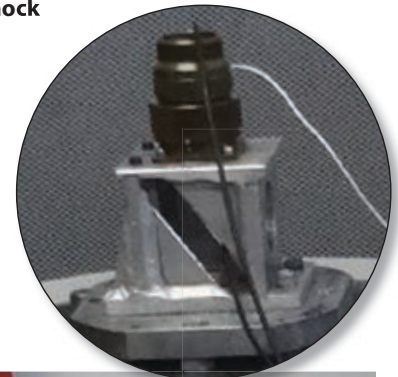

**METROLOGY**

DIMENSIONAL INSPECTION		
INSTRUMENT		ACCURACY
Visual Inspection	Microscope	Magnification X1000
Optical 3D measurement	Tesa Visio 300 DCC	(measuring range) X/Y=300X200mm (measuring range) Z=150mm X/Y-Accuracy at 20°C=2,4+4•L/1000Z- Accuracy at 20°C= 3+1•L/100*
Contour Measuring Instrument	Mitutoyo CV 4500S4	DZ1 axis=0,02um DX AXIS=0,05um (measuring range) Xaxis=0-100mm (measuring range) Z1 axis=0-60mm
Optical - Profile projector	Visual scope 300V	0-100mm D=0,001mm
Coordinate Measuring Machine CMM	Tesa Micro-Hite 3D	440 x 500 x 420 mm D=0,001mm
	Mitutoyo Crysta Apex-C	500x700x400mm D=0,001mm
Standard instrument	Height gauge	0-600mm D=0,001mm
	Caliper	0-600mm D=0,01mm
	Micrometer	0-150mm D=0,001mm
	Gauge	Thread, Dial, Bore, Johansson
METALLOGRAPHIC SECTION		
Sample preparation; potting of the sample, cross sectioning; measurement with microscope	NIKOM LV150NL (1000x)	D=0,01µm
CALIBRATION OF THREAD GAGE OR GAUGE BLOCK		
INSTRUMENT		ACCURACY
Thread measurement	DMS680	0-100mm D=0,0001mm
Inspection of plain plug and plain ring gage; Gauge block.		
Inspection of thread plug, thread ring		
HARDNESS TESTER		
INSTRUMENT		ACCURACY
Measure of metal hardness, VICKERS (HV)	Hardness tester Innovatest	HV0,02-HV50 D=0,1Hv
SURFACE ROUGHNESS TESTER		
INSTRUMENT		ACCURACY
Measure of roughness	Surtronic S128 Taylor-Hobson	D=0,01µm +/-500µm

Measurement Solutions Capabilities

**ACCURACY:** All our instruments are calibrated and evaluated for the most accurate measurement of your components

**FLEXIBILITY:** We measure and report on all components or just a single characteristic

**CAPABILITIES :** From calibration of customer's gauge tools to the design and manufacture of specialized gauges or fixtures.

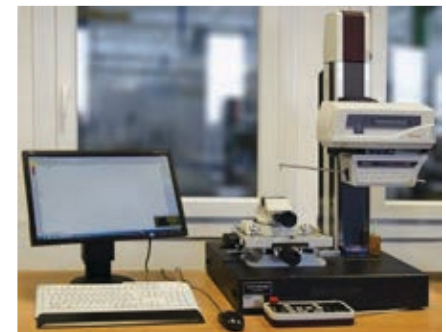
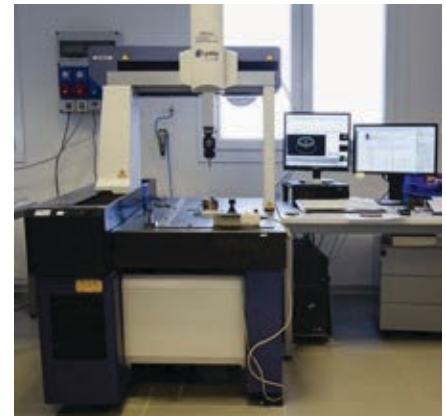



**Inspection Rubber**

**RUBBER**

RUBBER - PLASTIC MATERIAL INSPECTION		
INSTRUMENT		LEVEL
Control on batch formulation	Agilent Cary 630 FTIR spectrometer	400-4650cm <sup>-1</sup> D=4cm <sup>-1</sup>
Hardness measurement	Rupac Durometer Shore A 6110075	0-90ShoreA D=1ShoreA
Measure elongation at break and tensile strength	EXpert 7601 XLT D412 Tension Testing System	0-1000N D=0,01N
Density measurement	PCE-ABZ + Density determination kit	0-200g D=0,0001g
Compression set measurement	Gibitre C-Set	N/A
Dielectric Breakdown Voltage and Dielectric Strength (ASTM D149)	High voltage Tester Phenx 6CP50/10-3; Schleich GLP2	0-50KVAC 50-60Hz
Standard Test Methods for DC Resistance or Conductance of Insulating Materials (ASTM D257)	Megohmmeter Sefelec M1501M	0-1500VDC

We have all the instruments to make a characterization of rubber materials: formulation (FTIR), density, hardness, mechanical propriety, and electrical propriety.

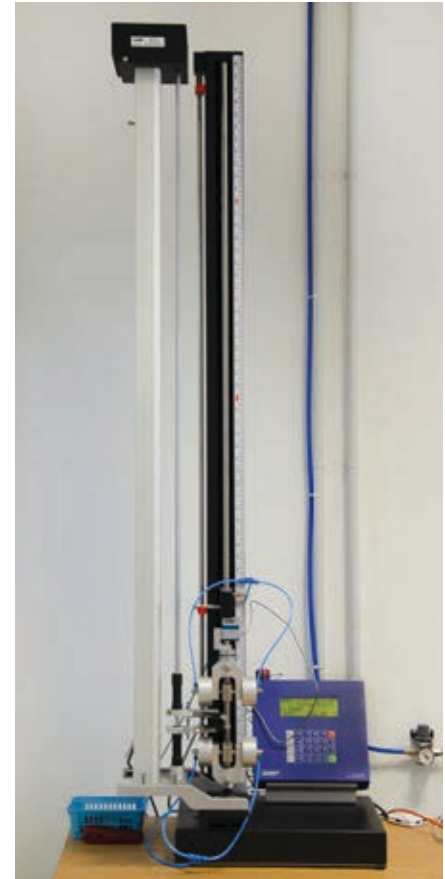
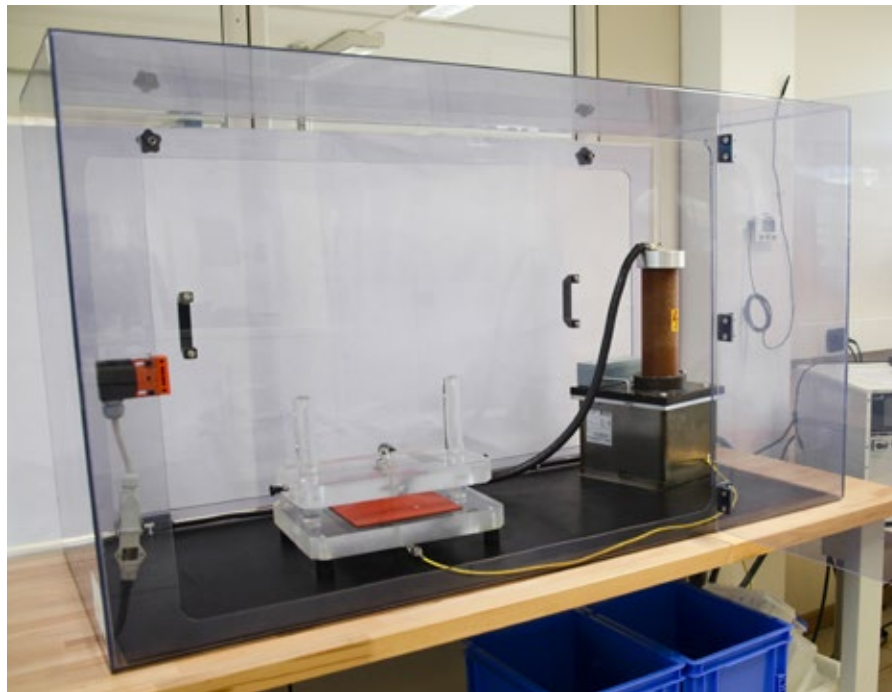

# Inspection Plating

## PLATING

PLATING INSPECTION		
INSTRUMENT		LEVEL
Metallic coatings thickness; Elemental composition of coatings	X-ray fluorescence spectroscopy (Fischerscope X-Ray XULM)	0-12,5um D=0,01um
Measure of the plating thickness (preparation of the samples; potting of the sample, cross sectioning; measure with microscope)	NIKOM LV150NL (1000x)	D=0,01um
Nonconductive coatings thickness (cataphoresis, painting) on non-ferrous metals, iron or steel	Magnetic inductive/Eddy current measurement instrument (Dualscope FMP20)	0-800um D=0,01um
Elemental composition of metal alloys/solutions	ICP-OES (Agilent 5110)	ppb
Copper sulfate test	N/A	N/A
Elemental composition of plating bath solutions	AAS (PerkinElmer PinAAcle 900T)	ppm

Our chemical plating lab can analyze your coating and help to ensure the correct formulation of the galvanic bath.

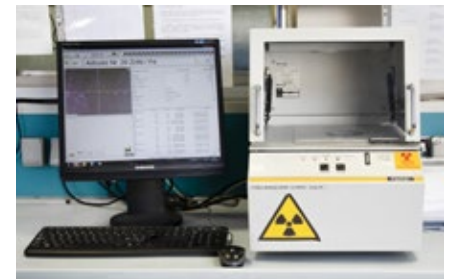

# Inspection Harness

## HARNESS

AUTOMATIC MEASUREMENT		
TEST	INSTRUMENT	LEVEL
Insulation resistance	EST AUTES750; WEETECH W434; WEETECH W454	up to 5000VAC;
Dielectric withstanding voltage		up to 1500VDC - 100GOHM
Resistance		Res.1mohm

MANUAL MEASUREMENT		
Insulation resistance	Megaohmmeter	I.R.:up to 1500VDC - 1Tohm
Dielectric withstanding voltage	High voltage tester	DWV: up to 1200VAC
Resistance	Ohmmeter	Resolution 0,001mohm
LC measurement (Inductance ; Capacitance)	Fluke PM6304	C=0,00pF to 31,8F; L=0,00uH to 63KH
Power Generator	Power generator DC and AC	up to 140VDC / 260VAC
Oscilloscope	Tektronix MSO5054	500MHz & 10 GS/s
Insertion loss (multimode - single mode)	Optical source, optical power meter, OTDR	850-1310-1550nm
Return loss (multimode - single mode)		850-1300-1310-1550
OTDR - Optical Time Domain Reflectometer		850/1300/1310/1550 nm
Ethernet	Fluke DSX5000	Up to Cat Fa (7a)
Air Leakage automatic	Fortest	Up to 6 Bar / 0,001mBar loss
Air Leakage manual	Manual pump	Up to 250 Bar
Air Flow	Air Flow meter Baggi	Up to 30 Standard litre per minute
Helium leakage	ASM340 Pfeiffer	5.10-12 mbar.l/s

Our harness final inspection guarantees fast and accurate testing of your wire harnesses with the latest automatic test equipment.

