

Printed Circuit Board Connectors

791-013P Receptacle Connectors with Straight Tail PCB Pin Contacts

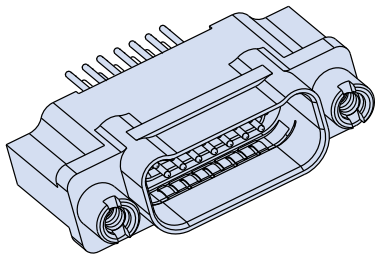

791-013P
PCB Receptacle

Harsh environment. Rugged construction. Ultraminiature. Series 791 connectors are the next-generation higher density alternative to M24308 D Subminiature and other rack-and-panel connectors. Dual lobe shell, recessed pins to prevent scooping damage. Epoxy-sealed terminals. Aluminum shell, thermoplastic insulator, fluorosilicone face seal, gold-plated copper alloy contacts, stainless steel jackposts. Integral board standoffs, threaded board mount holes. 5A to 46A current rating depending on contact size.

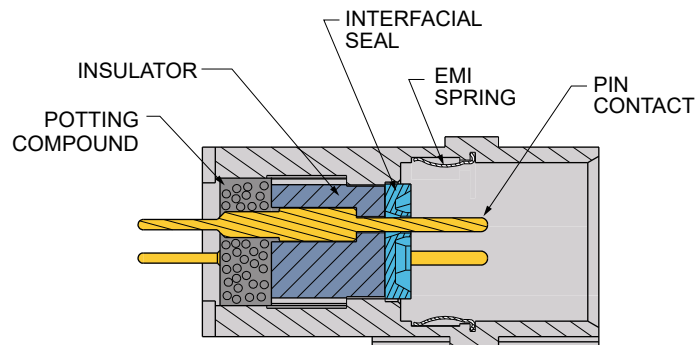

RELIABLE DESIGN

- 100% scoop-proof
- Sealed PC tail contacts
- EMI shell-to-shell continuity

VERSATILE

- Wide range of configurations
- #23, #16, #12 and #8 contacts
- Rear panel mount

HARSH ENVIRONMENT

- Humidity, water ingress
- Shock and vibration
- Temperature extremes
- Corrosion resistance
- High altitude

SIZE AND WEIGHT SAVING

- High density

How To Order

Sample Part Number	791-013P	K-43	MT	E	R1	A
Product	791-013P = Receptacle connector, straight PC tail, pin contacts					
Arrangement Number (Shell Size - Insert Arr.)	See Table 2					
Shell Finish	M = Electroless Nickel MT = Nickel-PTFE ZR = Black Zinc-Nickel					
EMI Spring	E = EMI spring N = No EMI spring					
Hardware Option (Table 1)	N = No jackposts P = Jackposts R1 = Rear panel jackposts, .032 (0.81) panel R2 = Rear panel jackposts, .050 (1.27) panel R3 = Rear panel jackposts, .062 (1.59) panel R4 = Rear panel jackposts, .080 (2.03) panel R5 = Rear panel jackposts, .093 (2.36) panel R6 = Rear panel jackposts, .125 (3.18) panel					
PC Tail Length	A = .125 inch (3.18) B = .250 inch (6.35) C = .375 inch (9.53)					

Specifications

- Operating temperature: -65 to +150°C
- Current and voltage ratings:

Contact Size	Amps, max.	DWV Vac rms
23	5	750
16	13	1800
12	23	1800
8	46	1800
- Shock: EIA-364-27 condition D
- Vibration: EIA-364-28 condition V, letter E
- See pages 8-10 for additional information

Construction

- Shell: aluminum alloy
- Insulators: high grade rigid dielectric
- Contacts: copper alloy, 50 microinches gold over nickel plating
- Interfacial Seal: fluorosilicone blend
- EMI spring: beryllium copper, nickel plated
- Hardware: 300 series stainless steel, passivated

Printed Circuit Board Connectors

791-013P Receptacle Connectors with Straight Tail PCB Pin Contacts

Table 1 Hardware Option











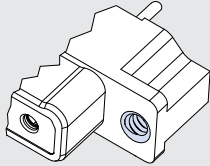
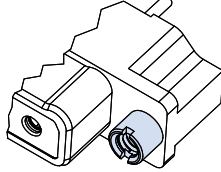
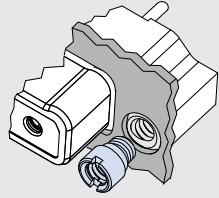



















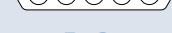



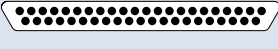

 <p>N No Jackpost</p> <p>Connector supplied with threaded holes, .150 (3.8) minimum depth. Shell sizes A-G, J, K have 6-32 UNC-2B thread, sizes H and L have 8-32 UNC-2B thread. Size M has 10-32 UNF-2B thread.</p>	 <p>P Jackposts</p> <p>Non-removable female jackpost. Shell sizes A-G, J, K have 4-40 UNC-2B thread, sizes H and L have 6-32 UNC-2B thread. Size M has 8-32 UNC-2B thread. 300 series stainless steel, passivated.</p>	 <p>R1 - R6 Rear Panel Jackposts</p> <p>For rear panel mounting of connector onto .032 - .125 inch (0.81 - 3.18) thick panels. Install with Loctite #272 threadlocking compound. Shell sizes A-G, J, K have 4-40 UNC-2B thread, sizes H and L have 6-32 UNC-2B thread. Size M has 8-32 UNC-2B thread. 300 series stainless steel, passivated. Supplied loosely assembled.</p>
---	---	--

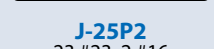
Table 2 Arrangement Number

Arrangements with Size #23 Contacts	Arrangements with Size #16 Contacts	Arrangements with Size #12 Contacts
 A-5 5 #23  B-9 9 #23  C-13 13 #23	 B-2P2 2 #16  D-3P3 3 #16  D-7P2 5 #23, 2 #16	 G-13P2 11 #23, 2 #12  G-3P3 3 #12  G-21P1 20 #23, 1 #12
 D-15 15 #23  E-19 19 #23	 E-11P2 9 #23, 2 #16  E-7P3 4 #23, 3 #16  F-14P3 11 #23, 3 #16	 H-10P4 6 #23, 4 #12  H-36P2 34 #23, 2 #12
 F-23 23 #23  G-33 33 #23	 F-15P2 13 #23, 2 #16  F-5P5 5 #16	 H-5P5 5 #12
 H-66 66 #23  J-33 33 #23	 H-29P7 22 #23, 7 #16  H-54P2 52 #23, 2 #16	 L-6P6 6 #12
 K-43 43 #23	 J-17P4 13 #23, 4 #16  J-25P2 23 #23, 2 #16	<p>Arrangements with Size #8 Contacts</p>  M-4P4
 L-78 78 #23	 J-7P7 7 #16  K-27P4 23 #23, 4 #16	
 M-102 102 #23	 K-35P2 33 #23, 2 #16  K-9P9 9 #16  M-17P17 17 #16	

Printed Circuit Board Connectors

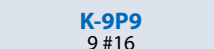
791-013P Receptacle Connectors with Straight Tail PCB Pin Contacts

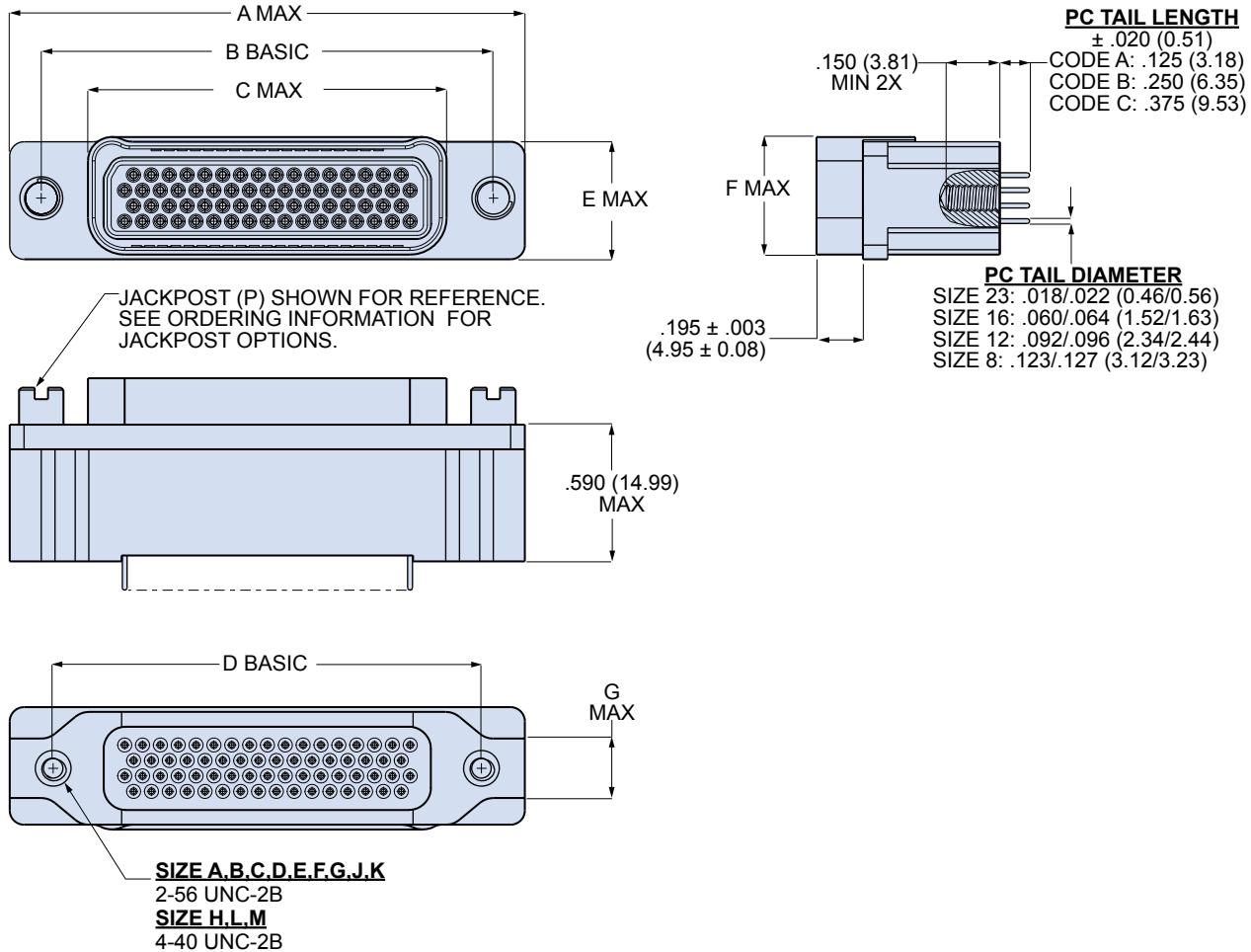

791-013P Dimensions

Shell Size	A Max		B Basic		C Max		D Basic		E Max		F Max		G Max	
	In.	mm.	In.	mm.	In.	mm.	In.	mm.	In.	mm.	In.	mm.	In.	mm.
A	.995	25.27	.750	19.05	.490	12.45	.565	14.35	.403	10.24	.400	10.16	.215	5.46
B	1.145	29.08	.900	22.86	.630	16.00	.715	18.16	.403	10.24	.400	10.16	.215	5.46
C	1.295	32.89	1.050	26.67	.780	19.81	.865	21.97	.403	10.24	.400	10.16	.215	5.46
D	1.370	34.80	1.125	28.58	.855	21.72	.965	24.51	.403	10.24	.400	10.16	.215	5.46
E	1.520	38.61	1.275	32.39	1.005	25.53	1.115	28.31	.403	10.24	.400	10.16	.215	5.46
F	1.670	42.42	1.425	36.20	1.155	29.34	1.265	32.13	.403	10.24	.400	10.16	.215	5.46
G	1.630	41.40	1.388	35.26	1.117	28.37	1.215	30.86	.491	12.47	.485	12.32	.215	5.46
H	2.180	55.37	1.900	48.26	1.507	38.28	1.800	45.72	.509	12.93	.500	12.70	.265	6.73
J	2.045	51.94	1.800	45.72	1.530	38.86	1.615	41.02	.403	10.24	.400	10.16	.215	5.46
K	2.420	61.47	2.175	55.25	1.905	48.39	2.015	51.18	.403	10.24	.400	10.16	.215	5.46
L	2.416	61.37	2.136	54.25	1.743	44.27	2.036	51.71	.509	12.93	.500	12.70	.265	6.73
M	2.580	65.53	2.200	55.88	1.804	45.82	2.200	55.88	.577	14.66	.585	14.86	.275	6.99

Printed Circuit Board Connectors

791-013P Receptacle Connectors with Straight Tail PCB Pin Contacts

R1 – R6 Rear Panel Jackpost

SIZE A-G, J, K

.250 (6.35)

SIZE H, L

.325 (8.26)

SIZE M

.360 (9.14)

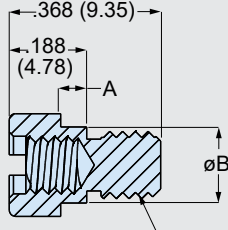
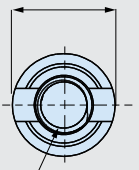

THREAD

SIZE A-G, J, K

4-40 UNC-2B

SIZE H, L

6-32 UNC-2B

SIZE M

8-32 UNC-2B

THREAD

SIZE A-G, J, K

6-32 UNC-2B

SIZE H, L

8-32 UNC-2B

SIZE M

10-32 UNF-2B

Code	A ± .003 (0.08)		øB
	In.	mm.	
R1	.032	0.81	Size A-G, J, K .200 (5.08)
R2	.050	1.27	Size H
R3	.062	1.59	Size M
R4	.080	2.03	.226 (5.74)
R5	.093	2.36	.252 (6.40)
R6	.125	3.18	

Recommended Panel Cutout for R1 – R6 Rear Panel Mount Jackposts

SHELL SIZES A-G, J, K

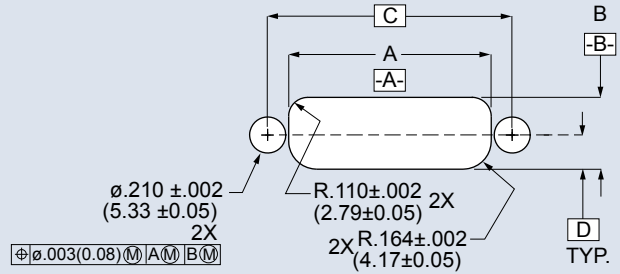

SHELL SIZES H, L

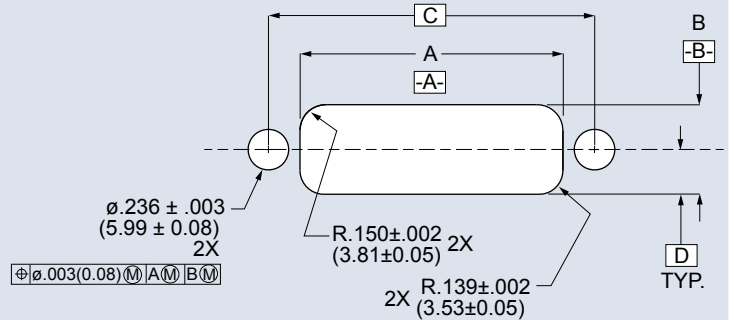

SHELL SIZE M

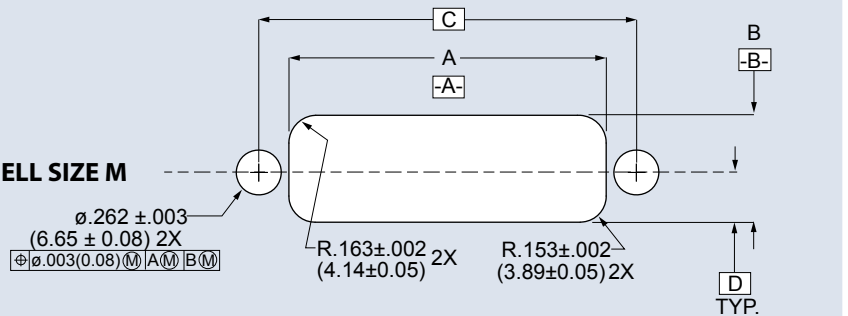

Shell Size	A ±.002(0.05)		B ±.002(0.05)		C Basic		D Basic	
	In.	mm.	In.	mm.	In.	mm.	In.	mm.
A	.505	12.83	.418	10.62	.750	19.50	.199	5.05
B	.655	16.64	.418	10.62	.900	22.86	.199	5.05
C	.805	20.45	.418	10.62	1.050	26.67	.199	5.05
D	.880	22.35	.418	10.62	1.125	28.58	.199	5.05
E	1.030	26.16	.418	10.62	1.275	32.39	.199	5.05
F	1.180	29.97	.418	10.62	1.425	36.20	.199	5.05
G	1.142	29.01	.506	12.85	1.388	35.25	.244	6.20
H	1.531	38.89	.521	13.23	1.900	48.26	.250	6.35
J	1.555	39.50	.418	10.62	1.800	45.72	.199	5.05
K	1.930	49.02	.418	10.62	2.175	55.25	.199	5.05
L	1.767	44.88	.521	13.23	2.136	54.26	.250	6.35
M	1.850	46.99	.623	15.82	2.200	55.88	.290	7.37