

Panel Mount Printed Circuit Board Connectors

791-012S Panel Mount Plug Connectors with Right Angle PCB Socket Contacts

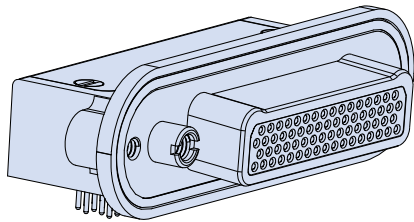

791-012S
Panel Mount PCB Plug

Harsh environment. Rugged construction. Ultraminiature. Series 791 connectors are the next-generation higher density alternative to M24308 D Subminiature and other rack-and-panel connectors. Dual lobe shell, mating receptacle has recessed pins to prevent scooping damage. Epoxy-sealed terminals. Aluminum shell, thermoplastic insulator, gold-plated copper alloy contacts, Integral board standoffs, threaded board mount holes. 5A to 46A current rating depending on contact size.

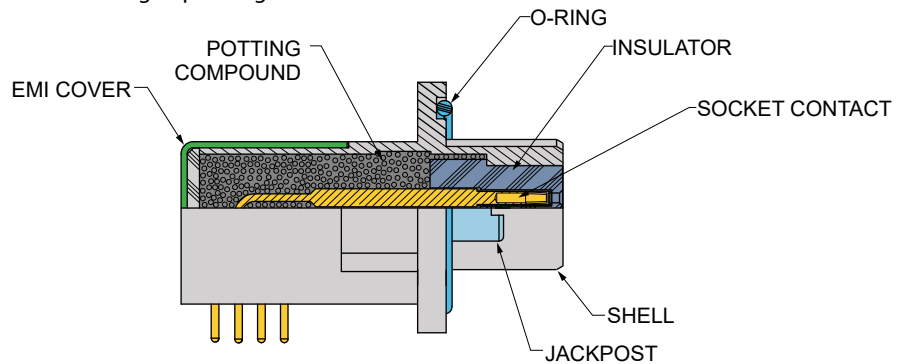

RELIABLE DESIGN

- 100% scoop-proof
- Machined aluminum shell
- Sealed PC tail contacts
- EMI shell-to-shell continuity
- Blind mate capability

VERSATILE

- Wide range of configurations
- Signal, power
- Rear panel mount

HARSH ENVIRONMENT

- Humidity, water ingress
- Shock and vibration
- Temperature extremes
- Corrosion resistance
- High altitude

SIZE AND WEIGHT SAVING

- High density

How To Order

Sample Part Number	791-012S	J-17P4	ZR	G	C	A
Product	791-012S Panel mount plug, right angle PC tail, socket contacts					
Arrangement Number (Shell Size - Insert Arr.)	See Table 2					
Shell Finish	M = Electroless Nickel MT = Nickel-PTFE ZR = Black Zinc-Nickel					
Hardware Option (Table 1)	N = No hardware) P = Jackpost G = Male guide pin B = Female guide bushing					
O-ring Option	N = No O-ring F = Fluorosilicone O-ring (non-conductive) C = Conductive fluorosilicone O-ring S = Metal EMI panel spring (non-environmental)					
PC Tail Length	A = .125 inch (3.18) B = .250 inch (6.35) C = .375 inch (9.53)					

Metal EMI Panel Spring

A gold-plated panel spring option is available for Series 791 connectors with panel mount flanges. This spring provides improved electrical bonding. Specify Code S. Non-environmental.



Specifications

- Operating temperature: -65 to +150°C
 - Current and voltage ratings:
- | Contact Size | Amps, max. | DWV Vac rms |
|--------------|------------|-------------|
| 23 | 5 | 750 |
| 16 | 13 | 1800 |
| 12 | 23 | 1800 |
| 8 | 46 | 1800 |
- Shock: EIA-364-27 condition D
 - Vibration: EIA-364-28 condition V, letter E
 - See pages 8-10 for additional information

Construction

- Shell: aluminum alloy
- Insulators: high grade rigid dielectric
- Contacts: copper alloy, 50 microinches gold over nickel plating
- Encapsulant: epoxy
- O-ring: fluorosilicone
- EMI cover: aluminum, same finish as shell
- Hardware: stainless steel, passivated
- O-ring (code F): fluorosilicone
- Conductive O-ring (code C): silver plated, aluminum-filled fluorosilicone
- Metal EMI panel spring (code S): beryllium copper, gold plated

Panel Mount Printed Circuit Board Connectors

791-012S Panel Mount Plug Connectors with Right Angle PCB Socket Contacts

Table 1 Hardware Option











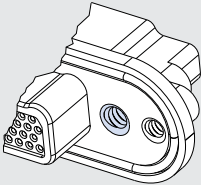
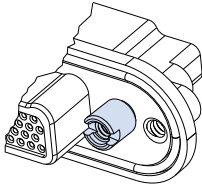
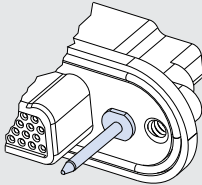
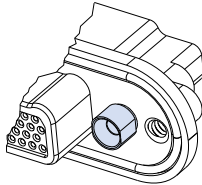



























 <p>N No Hardware</p> <p>Connector supplied with threaded holes, .150 (3.8) minimum depth. Shell sizes A-G, J, K have 6-32 UNC-2B thread, sizes H and L have 8-32 UNC-2B thread. Size M has 10-32 UNF-2B thread.</p>	 <p>P Jackposts</p> <p>Non-removable female jackpost. Shell sizes A-G, J, K have 4-40 UNC-2B thread, sizes H and L have 6-32 UNC-2B thread. Size M has 8-32 UNC-2B thread. 300 series stainless steel, passivated.</p>	 <p>G Guide Pins</p> <p>Non-removable, 300 series stainless steel guide pins for blind mating applications. Use with guide bushing on mating connector.</p>	 <p>B Guide Bushing</p> <p>Non-removable, 300 series stainless steel female guide bushings for blind mating applications. Use with guide pin on mating connector.</p>
---	---	---	--

Table 2 Arrangement Number

Arrangements with Size #23 Contacts	Arrangements with Size #16 Contacts	Arrangements with Size #12 Contacts
 A-5 5 #23  B-9 9 #23  C-13 13 #23	 B-2P2 2 #16  D-3P3 3 #16  D-7P2 5 #23, 2 #16	 G-13P2 11 #23, 2 #12  G-3P3 3 #12  G-21P1 20 #23, 1 #12
 D-15 15 #23  E-19 19 #23	 E-11P2 9 #23, 2 #16  E-7P3 4 #23, 3 #16  F-14P3 11 #23, 3 #16	 H-10P4 6 #23, 4 #12  H-36P2 34 #23, 2 #12
 F-23 23 #23  G-33 33 #23	 F-15P2 13 #23, 2 #16  F-5P5 5 #16	 H-5P5 5 #12
 H-66 66 #23  J-33 33 #23	 H-29P7 22 #23, 7 #16  H-54P2 52 #23, 2 #16	 L-6P6 6 #12
 K-43 43 #23	 J-17P4 13 #23, 4 #16  J-25P2 23 #23, 2 #16	<p>Arrangements with Size #8 Contacts</p> 
 L-78 78 #23	 J-7P7 7 #16  K-27P4 23 #23, 4 #16	<p>M-4P4 Supplied with 4 #8 Power Contacts</p>
 M-102 102 #23	 K-35P2 33 #23, 2 #16  K-9P9 9 #16	 M-17P17 17 #16

Panel Mount Printed Circuit Board Connectors

791-012S Panel Mount Plug Connectors with Right Angle PCB Socket Contacts

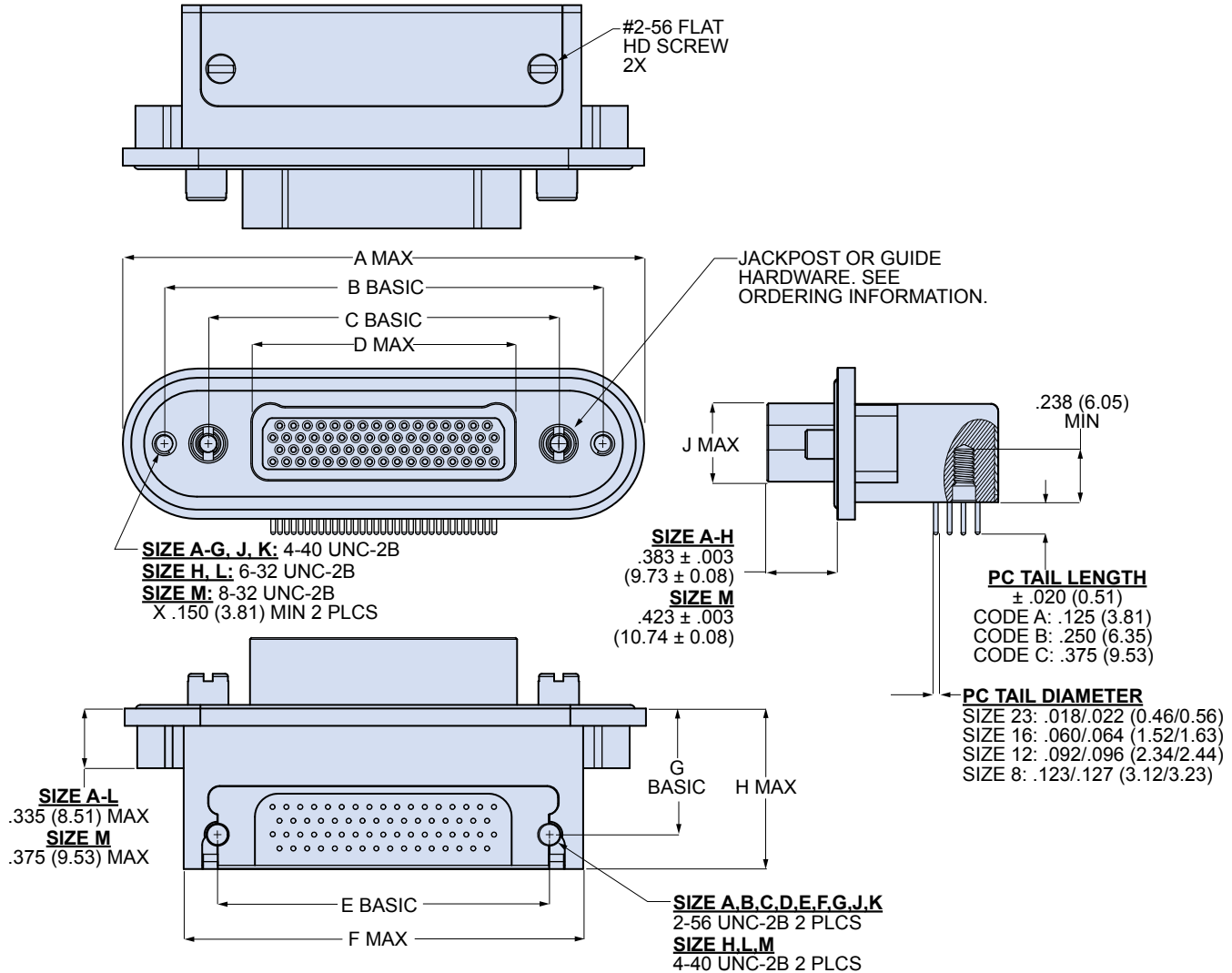

791-012S Dimensions

Shell Size	A Max		B Basic		C Basic		D Max		E Basic		F Max		G Basic		H Max		J Max	
	In.	mm.	In.	mm.	In.	mm.	In.	mm.	In.	mm.	In.	mm.	In.	mm.	In.	mm.	In.	mm.
A	1.565	39.75	1.150	29.21	.750	19.05	.410	10.41	.565	14.35	.990	25.15	.610	15.49	.725	18.42	.320	8.13
B	1.715	43.56	1.300	33.02	.900	22.86	.560	14.22	.715	18.16	1.140	28.96	.610	15.49	.725	18.42	.320	8.13
C	1.865	55.34	1.450	36.83	1.050	26.67	.710	18.03	.865	21.97	1.290	32.77	.610	15.49	.725	18.42	.320	8.13
D	1.940	49.28	1.525	38.74	1.125	28.58	.785	19.94	.965	24.51	1.365	34.67	.610	15.49	.725	18.42	.320	8.13
E	2.090	53.09	1.675	42.55	1.275	32.38	.935	23.75	1.115	28.32	1.515	38.48	.610	15.49	.725	18.42	.320	8.13
F	2.240	56.60	1.825	46.36	1.425	36.20	1.085	27.56	1.265	32.13	1.665	42.29	.610	15.49	.725	18.42	.320	8.13
G	2.200	55.88	1.785	45.34	1.388	35.26	1.047	26.59	1.215	30.86	1.625	41.28	.682	17.37	.800	20.32	.420	10.67
H	2.835	72.01	2.375	60.34	1.900	48.26	1.437	36.50	1.800	45.72	2.175	55.25	.691	17.55	.880	22.35	.430	10.92
J	2.615	66.42	2.200	55.88	1.800	45.72	1.460	37.08	1.615	41.02	2.040	51.82	.610	15.49	.725	18.42	.320	8.13
K	2.990	75.95	2.575	65.41	2.175	55.25	1.835	46.61	2.015	51.18	2.415	61.34	.610	15.49	.725	18.42	.320	8.13
L	3.075	78.11	2.611	66.32	2.136	54.26	1.673	42.49	2.036	51.71	2.411	61.24	.691	17.55	.880	22.35	.430	10.92
M	3.345	84.96	2.824	71.73	2.200	55.88	1.734	44.04	2.200	55.88	2.580	66.53	.798	20.27	.995	25.27	.515	13.08

Panel Mount Printed Circuit Board Connectors

791-012S Panel Mount Plug Connectors with Right Angle PCB Socket Contacts

Recommended Panel Cutout

SHELL SIZES A-G, J, K

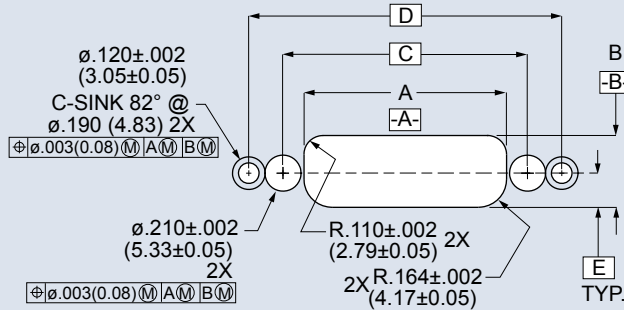

SHELL SIZES H, L

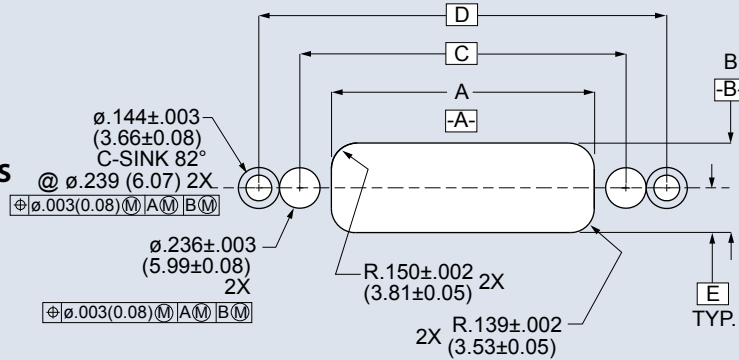

SHELL SIZE M

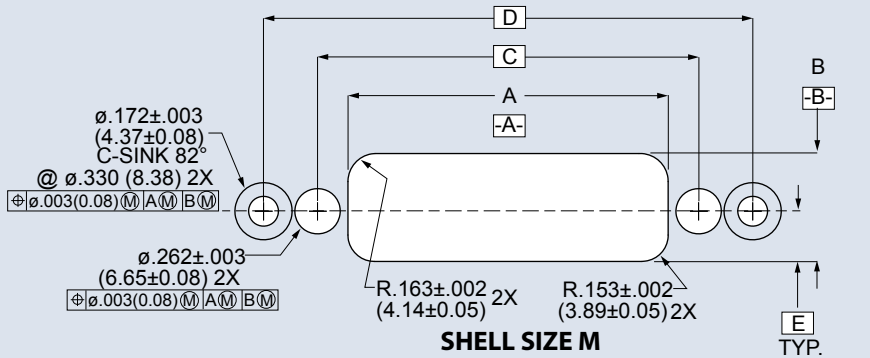

Application Notes

1. Supplied with (2) flat head screws for panel mounting. 82° c-sink with reduced head diameter to fit recommended panel cutout. Slot drive, stainless steel.

2. Blind Mate Tolerances

Shell Size	Maximum allowable misalignment from centerline
A - G, J, K	.030 (0.76)
H, L	.040 (1.02)
M	.050 (1.27)

Shell Size	A ±.002(0.05)		B ±.002(0.05)		C Basic		D Basic		E Basic	
	In.	mm.	In.	mm.	In.	mm.	In.	mm.	In.	mm.
A	.505	12.83	.418	10.62	.750	19.50	1.150	29.21	.199	5.05
B	.655	16.64	.418	10.62	.900	22.86	1.300	33.02	.199	5.05
C	.805	20.45	.418	10.62	1.050	26.67	1.450	36.83	.199	5.05
D	.880	22.35	.418	10.62	1.125	28.58	1.525	38.74	.199	5.05
E	1.030	26.16	.418	10.62	1.275	32.39	1.675	42.55	.199	5.05
F	1.180	29.97	.418	10.62	1.425	36.20	1.825	46.36	.199	5.05
G	1.142	29.01	.506	12.85	1.388	35.25	1.786	45.34	.244	6.20
H	1.531	38.89	.521	13.23	1.900	48.26	2.375	60.34	.250	6.35
J	1.555	39.50	.418	10.62	1.800	45.72	2.200	55.88	.199	5.05
K	1.930	49.02	.418	10.62	2.175	55.25	2.575	65.41	.199	5.05
L	1.767	44.88	.521	13.23	2.136	54.26	2.611	66.32	.250	6.35
M	1.850	46.99	.623	15.82	2.200	55.88	2.824	71.73	.290	7.37