

QwikConnect

GLENAIR ■ JULY 2015 ■ VOLUME 19 ■ NUMBER 3



$$x^{n-1} y^m \left] \frac{\partial w}{\partial x} = 0$$

CUSTOMER-DRIVEN
INTERCONNECT SYSTEM
INNOVATION

$$[e^{\alpha x} f(y) + c\beta] \frac{\partial w}{\partial x} - [e^{\beta y} g(x) + c\alpha]$$



CUSTOMER-DRIVEN INTERCONNECT SYSTEM INNOVATION

A Unique Glenair Approach to New Product Research and Development

Glenair has the same goals and objectives as other businesses, but with a few twists that we believe make us unique in the marketplace. Certainly we want to grow and prosper in our industry, but only in a manner that brings true utility and value to all the stake-holders in our business—from customers, to suppliers, owners, employees and community. One of the key elements in our game plan is a relentless commitment to customer-focused product innovation. In fact, the ability to bring innovative products to market that correctly address customer requirements—from every technical standpoint as well as timeliness, quality, and availability—is a major hallmark of our business. From ultra-small form-factor board-level innovations like AlphaLink™, to expanded beam fiber-optic solutions such as

Eye-Beam®, Glenair has become the go-to design partner for customers who depend on supplier innovation as a key element in their own success.

This special issue of **QwikConnect** details Glenair's unique approach to customer-driven innovation followed by an overview of our most recent inventions and solutions.

Innovation at Glenair

The following set of ideas and principles are not abstract theorems such as might be promoted in the MBA coursework at a school of business. They are in fact the practical, day-to-day models we use at Glenair to ensure the ongoing growth and success of our tree farm. Tree farm you say? Yes, that is the particular analogy we use internally to inspire and maintain an atmosphere of innovation. A tree farmer, so the story goes, must plant seedlings today that will become the mature, harvestable trees of tomorrow.



Imagine how weak an interconnect partner Glenair would be today if we had never planted new seed types beyond our original inventory of backshell designs. Happily, we are in fact well positioned to keep pace with, and at times even outstrip, the evolving needs of our customers with healthy, mature solutions ready for immediate use.



Just a small slice of the engineering talent at work at Glenair. In addition to our team in Glendale, we staff engineering offices in Paso Robles, Anaheim, Tucson, Chicago, Wallingford, Bologna, and Mansfield.

Otherwise, he will soon find himself harvesting the last of his mature trees, with nothing to offer his customers in the coming season. Simple stuff: Plant, nurture, harvest, repeat. The business of technology innovation is hardly different: today's seedlings become tomorrow's new product offerings. And just like any good farmer, Glenair follows a proven, time-tested model to ensure our tree farm of new product offerings conform to the tastes and requirements of the marketplace. Here's how we do it.

(1) A Humble Commitment to Listen to the Customer

Glenair currently manufactures and supplies a number of unique interconnect solutions that were bona fide game-changers when they were first introduced. The Series 80 Mighty Mouse is a perfect example. This "half-size" cylindrical



Let us be your design partner: Glenair has the most liberal NRE policy in the industry

Our tooling design team has all the capacity required for even the most aggressive production schedules

Three of the customers our engineering team remembers to take seriously in their work:



**Yes,
If...**

(2) Dedicated Resources

Nothing puts out the lamp of innovation faster than a lack of dedicated resources, be they human or equipment. Glenair, like most suppliers in our niche, undertakes an unbelievable amount of routine engineering work servicing our existing product lines. Most of our mil-aero connector engineers, for example, have a key daily responsibility to complete red-folder “bid-file” projects that are mostly sustaining engineering in nature. The modification of a shell flange on an existing connector design is a typical example. This work is time-sensitive and essential to our ability to provide quick turnaround on “custom” orders of standard interconnect technologies. Important work. But it does make it difficult for that same engineer to focus on innovation. For this reason, Glenair maintains a deep bench of research, development and design talent that can tackle longer-term work without the daily distraction of completing bid-files. And we

support this team with prototype machinery, tooling centers and lab equipment, as well as quick-turn CNC production capabilities that are not encumbered by the day-to-day work of the factory. This is not the norm in our industry. We believe we have by far the largest and most experienced engineering team in the mil-aero interconnect business as well as the highest number of designers focused solely on the development of new interconnect technologies.

(3) Big Bets

There are any number of new product development projects underway at Glenair. Some work falls into the “product line extension” category, such as the recently completed Mighty Mouse 824 locking quick-disconnect. But other work is much more ambitious and combines both new business as well as new product development. Our recently completed Photonics cell with its broad range of harsh-environment optical transceiver technologies, media converters, and so on is a good example of the latter. These “big bet” initiatives demonstrate Glenair’s commitment to growing our capabilities to meet the evolving and changing needs of our customers.

Another stand out example is our new PCB and flex fabrication facility. Designed to give Glenair the ability to deliver integrated / connectorized PCB/flex assemblies, the facility significantly

Our new printed circuit board/flex operation is up and running with the tooling, equipment and staffing required to design, lay out, and build connectorized PCB assemblies as well as the broad range of special-purpose electronics for incorporation into active interconnect technologies.

enhances our new product innovation work by bringing key technology in-house where it can add velocity to innovative interconnect designs that leverage flex.

As mentioned, Glenair has no attitudinal constraints when it comes to the support of new product innovation—from the acquisition of new equipment and the hiring of essential staff to the commitment of ample funding to R and D efforts.



Photonic lab test equipment: just one of the many dedicated resources available to research and development staff inventing the next generation of opto-electronic interconnect technologies.

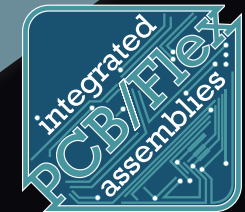

INTEGRATED PCB/FLEX ASSEMBLIES



One production control and quality system for all operations—from connector manufacture to PCB/flex layout, fabrication, assembly and test.

Everything under one roof

100% vertical integration—we make the connectors, we make the flex, and we assemble, test, and certify everything under one roof

Are you tired of auditing a supplier base that is spread out all over the map? At Glenair, our integrated PCB/Flex capabilities are truly under one roof. We offer unparalleled expertise in connectorized PCB design, termination and test. Our operation is managed under a single worldwide ISO 9001 and AS9100 certified quality system. Our flex fabrication cell delivers IPC 6012 and 6013 Class III manufacturing. And our assembly/termination team has a well-deserved reputation for on-time delivery of even the most complex, high-reliability PCB/Flex assemblies.



Complete assemblies and test fixtures



Panel preparation, chemical wash, etching and plating

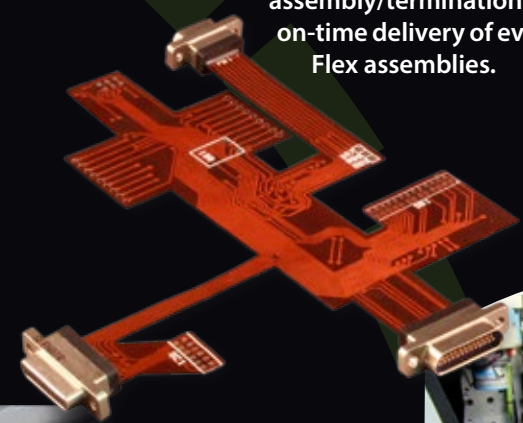

PCB / Flex drilling and routing



UV photo exposure



Multilayer layup



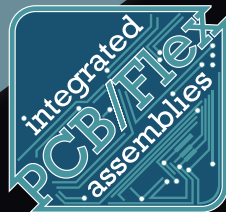

FOUR REASONS TO CHOOSE GLENAIR FLEX



Our vertically integrated PCB connector manufacturing capability makes Glenair an ideal choice for PCB assembly design and connectorization

1. UNSURPASSED EXPERIENCE IN FLEX CIRCUIT DESIGN

Glenair has been integrating high-reliability connectors into flex circuitry for over 30 years. Our technical capabilities include design and layout of turnkey assemblies as well as the production of custom-configured interconnects for maximum size and weight savings.

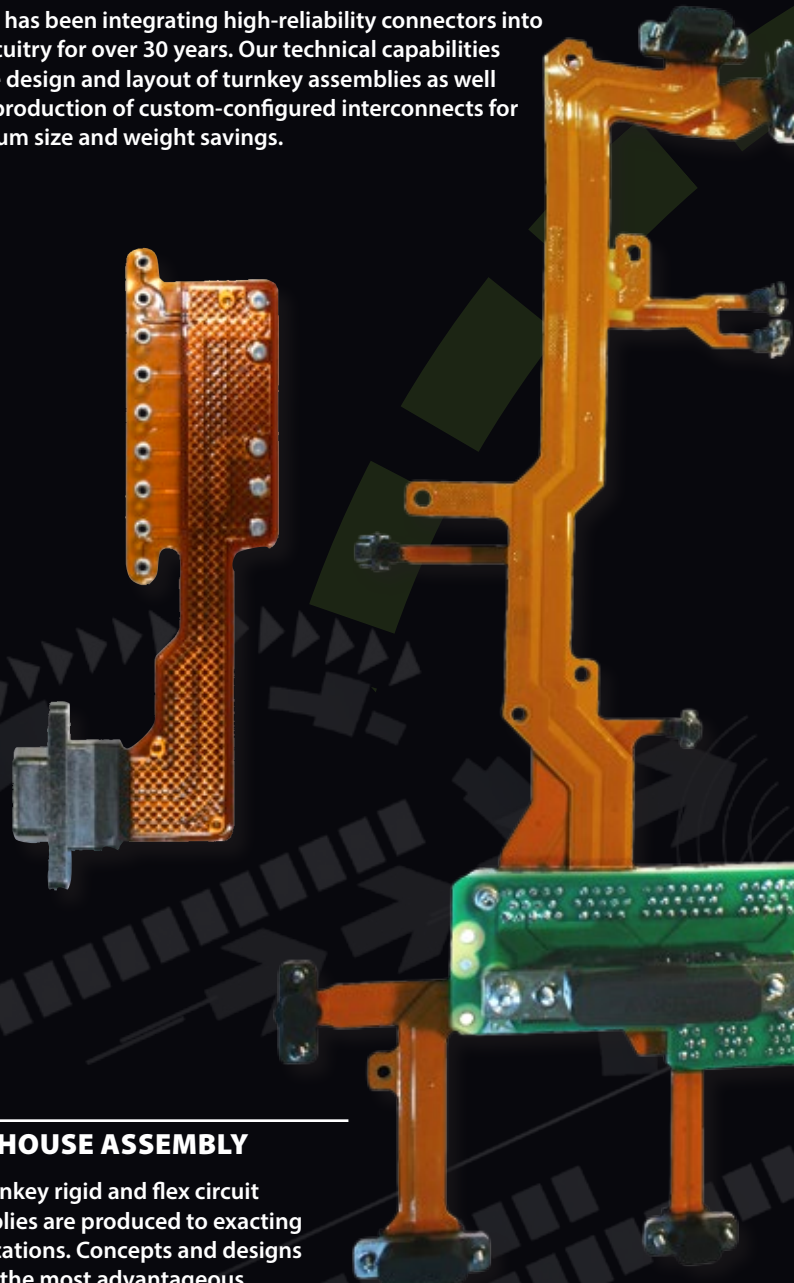

3. IN-HOUSE ASSEMBLY

Our turnkey rigid and flex circuit assemblies are produced to exacting specifications. Concepts and designs ensure the most advantageous utilization of EMI shielding, polarization, strain-relief and connector packaging technologies. Assembly of the final design is optimized to meet the exact mechanical and electronic requirements of the target environment.

2. FULL-SPECTRUM PCB CONNECTOR OFFERING

Glenair offers a complete range of printed circuit board connectors with high-reliability board terminations. We supply both through-hole and surface mount designs in every angle and mounting style for integration into single-sided, double-sided and multilayered flex circuitry.

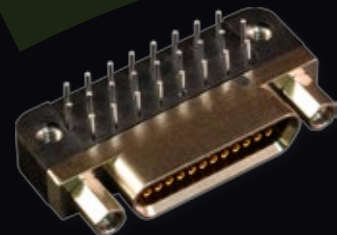

4. TERMINATION EXPERTISE

Glenair's experienced workforce is trained and qualified to produce consistently reliable circuit terminations using the most advanced techniques and technologies, including automated solder reflow systems.



(4) No Bubbles

Much of the time, innovations come from our product management and engineering teams responding directly to a customer with a solution to their interconnect issue. But it is also a fact that innovation can come from any quarter. More so, that meaningful innovation often comes from outside the walls and discipline of any particular industry. Many of the most significant innovations in current use on the diagnostic side of the medical industry, for example, came from technologies that were invented outside of hospitals and medical research labs. From X-Ray technology to MRIs, today's diagnostician has physics labs to thank for the tools now most relied upon in internal medicine. As biochemist Arthur Kornberg noted, "X-rays were not discovered because such a technique was needed in medicine and surgery. X-rays were discovered because physicists were curious about an utterly esoteric question: how electricity behaved in a vacuum." We apply fanatical attention at Glenair to bringing in and leveraging the product

development and design talent of folks who did not grow up inside our industry. From materials engineers to experts in design prototyping and packaging, our R and D team benefits from the insights and contributions of individuals who bring an outside perspective to the work. Again, this is not the norm in our industry. Typically, unless you are a "connector-guy" you are unlikely to find a seat on most interconnect engineering teams.



The chemical makeup of Glenair's innovative Duraelectric™ cable jacket was formulated in-house by an engineer recruited from the food and beverage industry.

(5) Empowered People

Innovation is not a micro-managed process at Glenair. Sure, we have a New Product Rollout committee that meets regularly, with appropriate measures for coordinating key deliverables such as tooling, qualification testing, marketing collateral and so on. But Glenair employs a distributed approach to innovation that gives individual designers within our many product groups the freedom to take risks and try out new ideas without fear of failure, or the too-heavy hand of management. In fact, quite a number of recent Glenair interconnect innovations originated as "skunk works" type projects free from executive management oversight. Our nanominiature SuperFly® connector series, for example, began life as just such a project only to become one of our most popular new offerings for future soldier systems. Simply put, innovation at Glenair is not subject to the same constraints it suffers from in other organizations. New product teams are not required to adhere to strict budgets, timelines, return-on-investment calculations or other constraints that might inhibit their appetite to take risks and stretch the boundaries of our business.

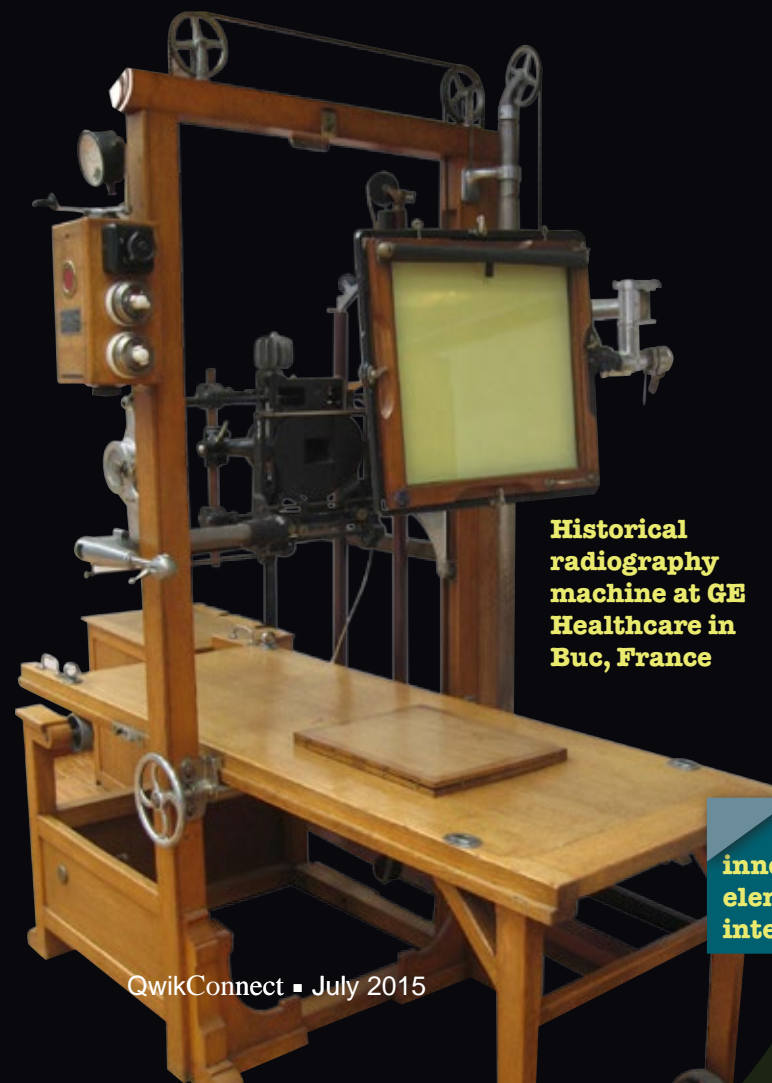

Historical radiography machine at GE Healthcare in Buc, France

An openness to, and solicitation of, ideas and innovations from outside our industry has been a key element of Glenair's successful development of new interconnect technologies.

STOP NUMBER ONE: Glenair is committed to new product innovation. On the first stop of this virtual factory tour, we invite you to witness the many interconnect technologies invented at Glenair over the past half century.



The Series 88 SuperFly® began its life as a rogue R and D project. Glenair engineers are empowered to take the initiative to understand and solve customer problems without micromanagement.

(6) Tools of the Trade

We often describe Glenair as a uniquely responsive interconnect company of scale. No other company combines the responsiveness of our technical support team, the productive capacity of our first-world based factories, or the speed and availability of our massive same-day inventory. Our fully integrated factories in Glendale, Mansfield and Bologna are perhaps the most important elements on this list. From prototyping labs to tooling centers, quick-turn

machining operations, plating, injection molding, cable fabrication, testing—you name it—Glenair has an in-house capability that brings control, flexibility and velocity to every new product development and production project. Our fully integrated EMI filter connector fabrication cell is a perfect example: every aspect from ceramic formulation to assembly and burn-in qualification is accomplished in-house. Imagine the control, flexibility and velocity our filter team enjoys when tackling a new or innovative filter connector design. And the same holds true for every other product group at Glenair. Our model is to expect—as a matter of faith—that no matter how complex or challenging a fabrication process may be, we will undertake to master it in-house.



As mentioned above, the norm at Glenair is the elimination of constraints. So when our R and D team needs additional tools of the trade to be successful, nothing stands in their way.

The **Glenair Glendale Factory Tour** that begins on the next page is a top-level overview of our current factory capabilities—the tools of the trade we use not only for production work, but to support our design teams in their development work.

Our EMI filtered connector capabilities are a perfect example: every step in the fabrication process, from ceramic formulation to plated filtered sub-assembly is completed in-house.

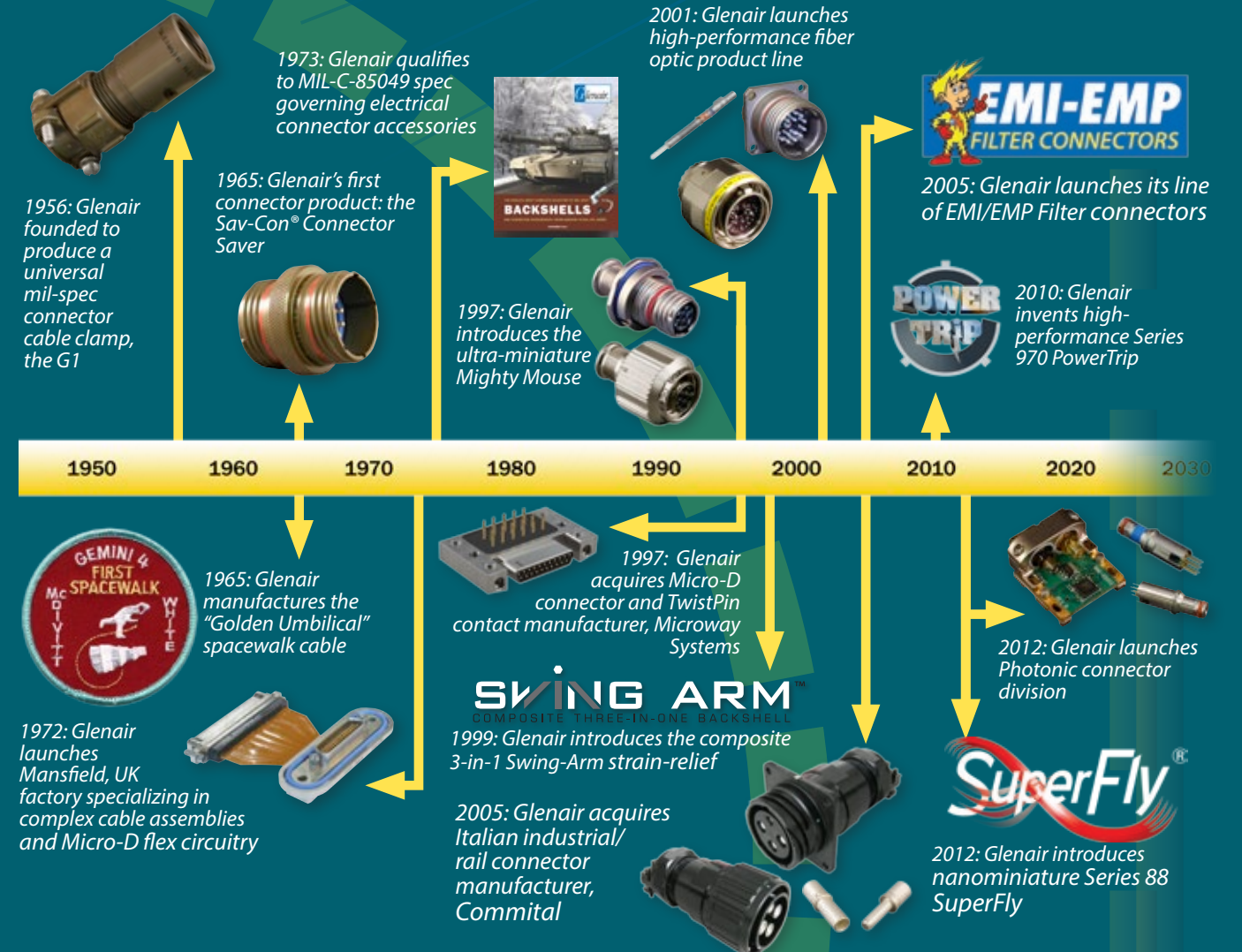

More Glenair milestones and innovations:





STOP NUMBER TWO: Machining of interconnect shells is an essential capability for any connector manufacturer. Glenair owns and operates by far the largest precision shell manufacturing facility in America.



Vertically-integrated US-based factories



The industry's largest and most experienced North American based interconnect component machining operation—literally hundreds and hundreds of CNC turning and milling centers

STOP NUMBER THREE: Glenair's composite and resilient material injection molding and extrusion capabilities include robotic systems as well as quick-turn small quantity machinery run by skilled craftsmen.



Just a small portion of Glenair's composite thermoplastic injection molding equipment used in the fabrication of lightweight, corrosion-resistant connectors and backshells



Precision overmolding of harsh environment connector assemblies with chemically-resistant materials such as Viton® and Duraelectric®



The extrusion of lightweight, high-temperature wire protection conduit in a broad range of materials including PEEK, PFA, PTFE, and Kynar



Glenair's die casting operation supports large-volume interconnect requirements—from backshells to conduit fittings, industrial connector shells and more



Our massive screw machine operation produces connector component parts such as coupling nuts in quantities to meet the industry's largest volume requirements



The ability to produce Glenair's broad range of composite thermoplastic interconnect components depends on massive expenditures in tooling (above) as well as a trained, professional workforce (left)



STOP NUMBER FOUR: Glenair's 100% vertically integrated factory includes every essential specialty operation—from stamping presses to certified welding cells, automated solder sleeve lines, hermetic furnaces, cable shield overbraiding, plating, and more.

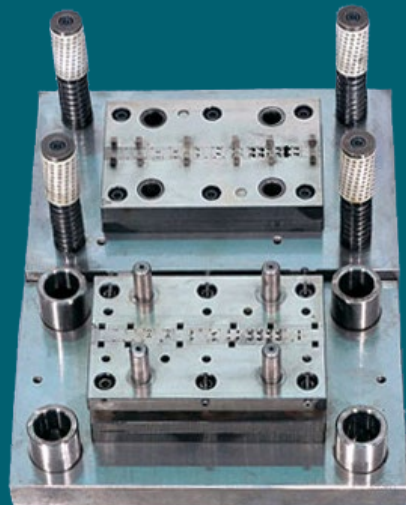

Stamping press technology enables Glenair to produce large quantities of quality-controlled component parts such as strain-relief saddle bar clamps. As in other areas, the commitment to produce and maintain the broad range of tooling required is a key manufacturing requirement

Many specialty interconnect components such as 45° and 90° angled backshells require skilled welding and/or brazing.



Glenair fully automated solder sleeve fabrication cell



Metal and fabric cable harness overbraiding facility



Firing oven for vitreous-seal hermetic connectors



NADCAP certified plating facility

STOP NUMBER FIVE: Final assembly and testing of discrete connectors and electrical and fiber optic cable assemblies is, once again, an integrated capability in all our worldwide factory operations.



Each connector series and product division at Glenair is empowered with its own dedicated assembly team, ensuring fast turnaround and high availability

Small form-factor connector assembly is intense, precision hand labor. Our operators have long tenure and broad experience with our high-reliability, mission-critical connector offering.



Glenair not only manufactures every popular military/aerospace connector series, we also operate our own in-house electrical and fiber optic cable assembly facility



Left: final population and assembly of a Mighty Mouse contact insulator. Above: Glenair's conduit division specializes in both discrete conduit system component manufacture as well as turnkey terminated and tested wire protection conduit assemblies.



CUSTOMER-DRIVEN INTERCONNECT SYSTEM INNOVATION

A small sample of recent Glenair interconnect innovations. See the following pages for more details. Contact the factory for price and delivery.

Reducing the Size and Weight of Electrical Wire Interconnect Systems

MIGHTY MOUSE
Half the size and weight of MIL-DTL-38999

SuperFly
New locking push-pull Mighty Mouse

SuperJack
Nanominiature tactical connectors and cordsets

UNDM HURRI
HOLD DOWN RELEASE MECHANISM
Scalable HDRM designs for CubeSat applications

ARMORLITE
Ultra lightweight microfilament EMI/RFI shielding

harsh-environment connector for audio, data, and power

Accelerating Data Rate and Bandwidth Capabilities of High-Speed Interconnects

SuperNine
SuperNine® with Ultra-Twin, Quadrax, and other shielded contacts

El Ochito
El Ochito™: the ultimate Ethernet data contact

OctoByte
OctoByte™ 4/8 pole modular contact system for industrial applications

Bringing Fiber Optics and Photonics to Harsh Environment Applications

EYE-BEAM
ARINC 801 connectors and termini for mil-aero data networking

Eye-Beam GLT
Eye-Beam GLT expanded-beam fiber optic termini

Eye-Beam GMA
Eye-Beam GMA ball lens expanded beam connectors and cables

GHD
GHD High-density fiber optic connection system

Photonics
Size #8 Photonic contacts for integration into standard connectors

Small form-factor PCB-mount transmitters and receivers

Extending the Benefits of Small Mil-Aero I/O Connectors to Board-Level Applications

AlphaLink
The spring-loaded contact, solderless board-level connector

nano miniature
Threaded and QDC circular PCB nano

Well-Master 260
Ultra high-temperature Micro-D PCB mount

MICROCRIMP
High-performance crimp contact board and wire Micro-D

Advancing Power Connector and Cable Electrical Performance

POWER TRIP
High ampacity, high density next-generation power connector

SUPER ITS
Next-generation reverse bayonet power connector

turboflex
Ultra-flexible power distribution cables with Duralectric jacketing

Fast, Reliable Tool-Free Mating

MasterMatch
Snap-to-mate thumb trigger release Micro-D

MOUSEBUD
Snap-to-mate thumb trigger release Mighty Mouse

Field-Installable, Flexible Wire Protection

HATTRICK
Ultra-fast tool-free installation conduit

Versatile EMI/RFI environmental wire protection

Reducing the Weight and Improving the Performance of Shield Termination Devices

EGG NELSON
EMI/RFI piggyback boot and backshell assemblies

SWING ARM
COMPOSITE THREE-IN-ONE BACKSHELL
3-in-1 cable clamp and shield termination device

STARSHIELD
Zero termination length individual wire shield backshell

Band-Master ATS
Lighter weight, calibrated shield termination

HOLLYWOOD

California City and State Song Titles

Find all 25

California



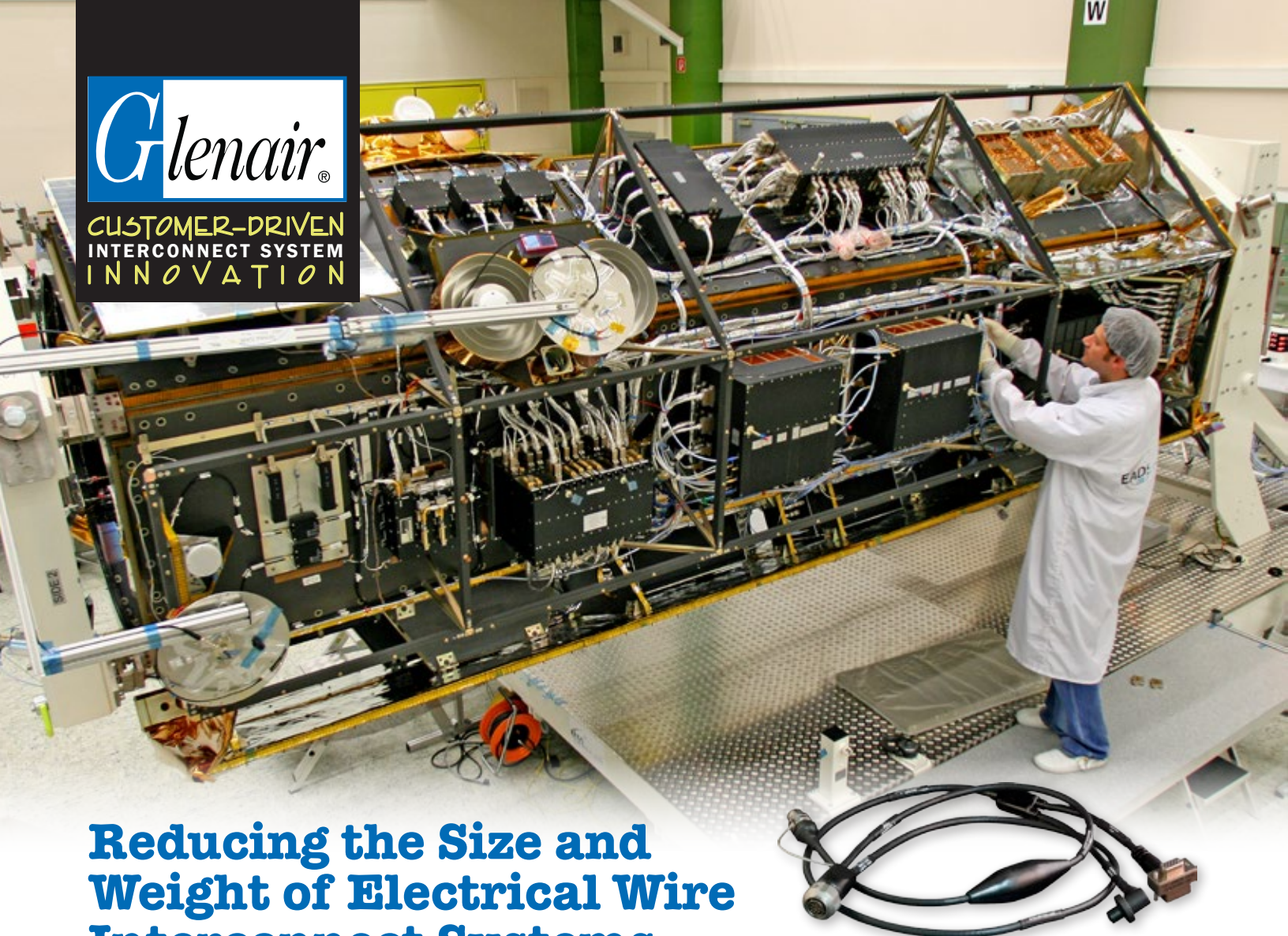

Reducing the Size and Weight of Electrical Wire Interconnect Systems

From wearable soldier systems to nanominiature CubeSat devices for space, Glenair is the industry leader in innovative size and weight reducing interconnect technology

▲ Tasked with designing a reliable, rugged, and lightweight EMI shielded multibranch cable for a soldier-portable GPS system, Glenair incorporated metal clad composite braided shielding and ultraminiature Mighty Mouse and rectangular connectors

MIGHTY MOUSE: THE INDUSTRY STANDARD ULTRAMINIATURE INTERCONNECT—FROM AEROSPACE TO SOLDIER SYSTEMS

- 6 coupling styles and 67 contact arrangements from 1 – 130 contacts
- MIL-DTL-38999 caliber environmental, mechanical, and electrical performance
- Ultraminiature #23 contacts set on .076" centers
- Size #20, #20HD, #16, #12, #8 signal, power, fiber optic and shielded contacts
- Discrete connectors and turnkey cable assemblies
- High-speed, high-density, and fiber optic versions available
- New Series 824 locking push-pull features fast mating, quick-release coupling mechanism



Reducing the Size and Weight of Electrical Wire Interconnect Systems

Mighty Mouse • SuperFly® • SuperJack™ • HDRMs • ArmorLite™

SUPERFLY®: THE ULTIMATE NANOMINIATURE TACTICAL CONNECTOR/CORDSET



- IP67 sealed, high shock / vibration, robust emi shielding
- Designed for high speed data applications
- Pre-wired, epoxy-sealed cordsets
- Straight and 90° PC tail receptacles
- 27 Contact arrangements
- Front or rear panel mounting
- Aluminum or stainless steel
- 5 Amp, 3 Amp, and 1 Amp contacts, accepts #22 to #32 AWG wire

SUPERJACK™ HARSH-ENVIRONMENT CONNECTOR FOR AUDIO, DATA, AND POWER



- 5 Amp current rating, 500 VDC
- 5000 mating cycles, EMI Shielded, IP67 ingress protection
- Optional spring-loaded sealing flap in jack
- 3 – 7 circuit configurations
- Suitable for blind-mate applications
- Hardened for temperature extremes from -45° to +125° C

SCALABLE HOLD-DOWN RELEASE MECHANISM (HDRM) TECHNOLOGY FOR CUBESATS

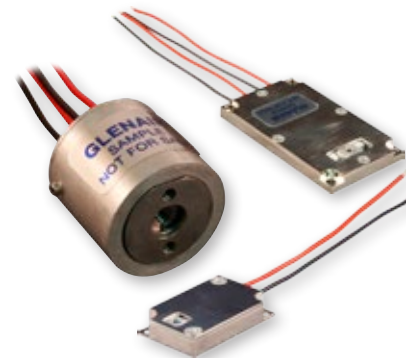

- Pyrotechnic-free alternative for single-event release of deployable space systems
- Scalable designs: from miniaturized Nano-Satellite versions to rated 5000 pound units
- Not susceptible to transient and noise (EMI/EMP/ESD/RFI) inputs
- Extended temperature ranges: -120°C to +120°C
- User-serviceable/ reusable
- Fuse-wire based technology
- Electrical initiation up to 5 Amps

ARMORLITE™ MICROFILAMENT NICKEL-CLAD STAINLESS STEEL EMI/RFI BRAIDED SHIELDING



- Suited for high-temperature applications, -80°C to +260°C
- 70% lighter than NiCu A-A-59569/QQB575
- Outstanding EMI/RFI shielding and conductivity
- Aerospace environment qualified
- Superior flexibility and windowing resistance: 90–95% optical coverage
- 220,000 psi (min) tensile strength
- Best performing metallic braid during lightning tests (Run to ANSI/ EIA-364-75-1997 Waveform 5B)



Accelerating Data Rate and Bandwidth Capabilities of High-Speed Interconnects

Glenair is at the forefront of designing high-performance, harsh environment connectors for high-speed applications. Offerings include industry-standard Quadrax and Twinax contacts incorporated into enhanced performance mil-circular connectors and rugged industrial-strength ITH series connectors—and the revolutionary El Ochito® contact for a full Ethernet channel in each standard size #8 cavity.



▲ These SuperNine® “better than QPL” high-speed connectors feature 1500 mating cycle ratcheted coupling technology and integrate El Ochito™ contacts for one full Ethernet channel per size #8 contact cavity

Accelerating Data Rate and Bandwidth Capabilities of High-Speed Interconnects

SuperNine® • El Ochito™ • Octobyte™

SUPERNINE® MIL-DTL-38999 SERIES III TYPE HIGH-SPEED CONNECTORS



- “Better-than-QPL” performance in mating-cycle and contact durability
- Advanced ease-of-use features such as integrated band porches and PC-Tail standoffs
- Supported applications: 10/100/1G/10G BASE-T Ethernet, analog/digital video, 1553 databus and general RF or differential data transmission
- Full range of hybrid insert arrangements incorporating size #22D signal contacts, plus size #12 and #8 keyed shielded contacts
- Turnkey Quadrax and El Ochito® solutions—from contacts to connectors, wire and termination hardware

EL OCHITO®: THE ULTIMATE ETHERNET DATA CONTACT



- One full Ethernet channel per standard size #8 cavity—accepts 26 AWG cable
- Fast and easy crimp termination of wires to contacts, with factory terminated jumpers and PC tail versions available
- 100% drop-in solution to installed connectors with no redesign or reinstallation of interfaces
- Supplied in the connector of your choice—up to 8 Ochito modules in a size 25 D38999 type connector
- Integral spline and short termination maximizes interconnect/cable performance and minimizes crosstalk
- The highest density contact system available—twice the density of Quadrax, split Quadrax, or other shielded contact solutions
- Tested, qualified, and in-stock for immediate shipment

OCTOBYTE™: THE FASTER 4/8 POLE CONNECTOR SYSTEM FOR RUGGED ETHERNET APPLICATIONS



- Rugged and reliable Series ITH connectors, specially configured for high-speed Ethernet applications
- Durable reverse-bayonet mating
- For harsh application environments
- Audio/video/digital displays, monitoring and control systems, data control and safety systems
- Tested in accordance with ISO F0 STP: CAT 7A; EN50173-1 F600-STP: CAT 7; EN50173-1 D STP: CAT 5E



Bringing Fiber Optics and Photonics to Harsh Environment Applications

High density fiber optic systems, expanded beam termini and connectors, and easy-to-integrate copper-to-fiber conversion

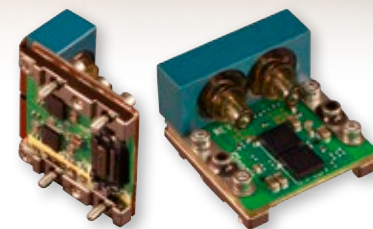

▲ Vibration-resistant and temperature-tolerant, Glenair small form factor PCB mount transmitters and receivers bring copper-to-fiber media conversion directly to the board

HARSH ENVIRONMENT, SMALL FORM-FACTOR PHOTONIC INTERCONNECT SOLUTIONS



- Photonic contacts and PCB mount transceivers
- Ethernet, video, and signal aggregation media converters and Ethernet switches
- Reduced size, weight, and power consumption
- Leverage the virtues of fiber optics: EMI immunity, network security, increased transmission distance and high bandwidth
- High shock and vibration to support mil/aero applications
- Wide operating temperature range: -40°C to +85°C and beyond
- Designed IAW military and aviation requirements: MIL-STD-883, MIL-STD-461, DO-160 and others
- Install Photonics in a fiber optic backbone for future requirement expandability without re-cabling

Bringing Fiber Optics and Photonics to Harsh Environment Applications

Eye-Beam® • GHD • Photonics

EYE-BEAM® GLT EXPANDED BEAM FIBER OPTIC TERMINI AND FACTORY-TERMINATED JUMPERS



- All the benefits of an expanded beam connection system built into a discrete, removable F/O terminus
- Factory-terminated F/O Eye-Beam® jumpers easily integrated into any connector package
- Innovative expanded beam GRIN lens terminus expands signal 27X from a standard 9.3 micron fiber core
- Revolutionary design delivers low dB loss (1.5 dB multimode, 2.0 dB singlemode) performance while reducing maintenance, inspection and test costs
- Ultra-high precision ceramic sleeves and custom designed terminus bodies ensure perfect axial alignment

EYE-BEAM® GMA BALL LENS EXPANDED BEAM CONNECTORS AND CABLES



- Field-deployable system for both indoor and outdoor applications
- Beam expansion dramatically reduces loss due to contamination
- Large ball lens facilitates easy cleaning
- HMA type, fully intermateable with all MIL-DTL-83526/20 and /21 compliant connectors
- 2 and 4-channel insert arrangements
- Singlemode and multimode versions, plus broad support for a wide range of standard and tactical military cables

GLENAIR HIGH DENSITY (GHD) FIBER OPTIC CONNECTION SYSTEM



- Innovative #18 (1.25mm ferrule) front-release genderless termini accommodate 900µ to 2.0mm jacketed fiber
- M85045/16 cable accommodation
- Composite, aluminum and stainless steel shells available
- Single keying for APC polish available
- Better optical performance than D38999 with nearly double the density
- Precision alignment sleeve retainer with integrated guide pins
- Piston o-ring sealing—submersible design

ARINC 801 FIBER OPTIC CONNECTORS AND TERMINI FOR MIL-AERO DATA NETWORKING



- Genderless terminus design eliminates pin and socket complexity
- Rear-release size #16 termini
- Singlemode (1310 and 1550 nm) as well as multimode (850 and 1300 nm)
- Mechanical and environmental performance IAW MIL-DTL-38999 Series III

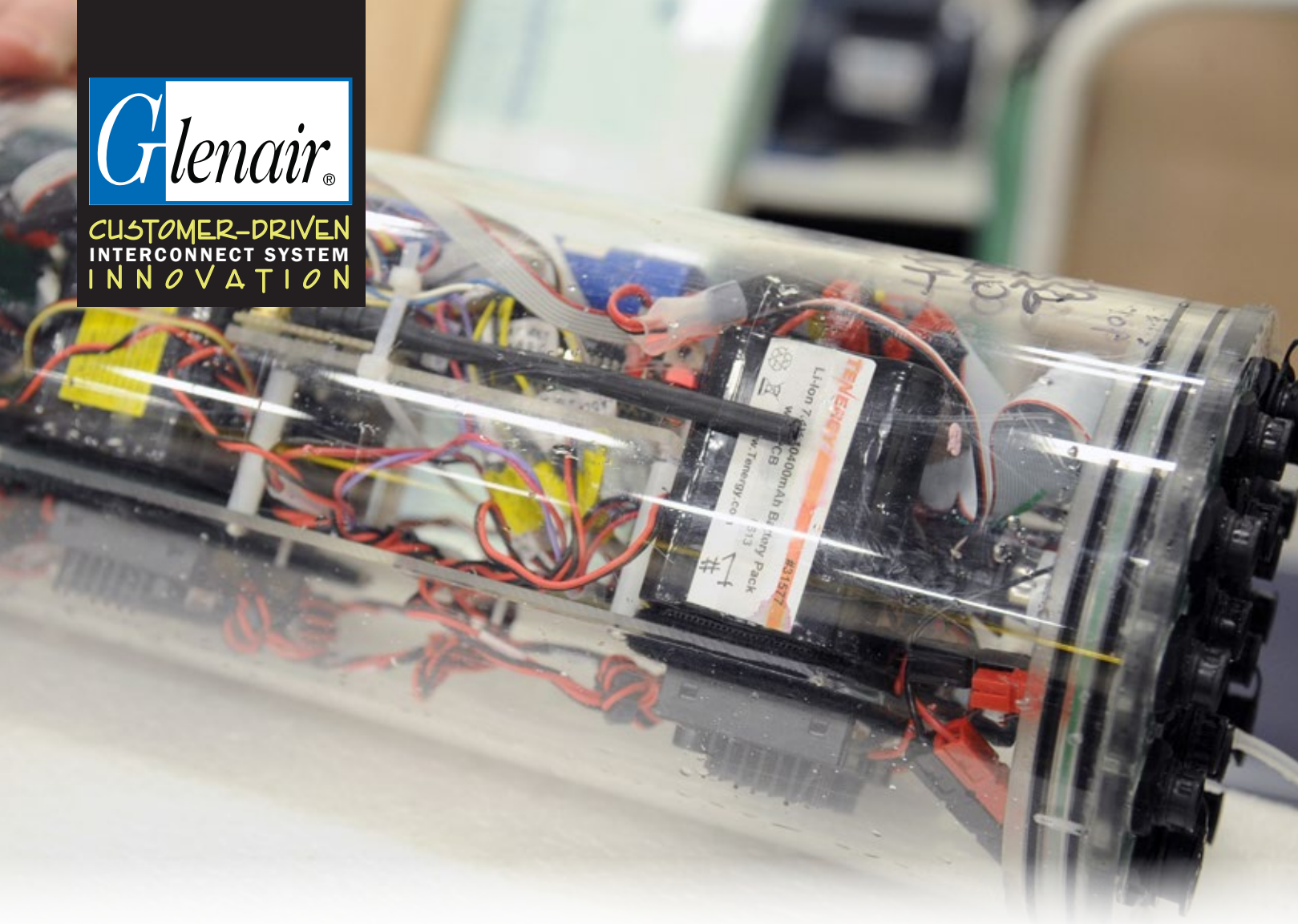

Extending the Benefits of Small Mil-Aero I/O Connectors to Board-Level Applications

Glenair brings extreme high-temperature tolerance, environmental sealing, EMI shielding, advanced materials and platings, and space-saving shell designs to printed circuit board applications with a broad range of board-level interconnect solutions—from our spring-loaded contact AlphaLink™ connectors to the advanced-performance Micro-Crimp



▲ Well-Master® 260° connectors withstand temperatures to 260°C and feature unique angled mounting ears for incorporation into cylindrical packages such as those found in downhole tools

Extending the Benefits of Small Mil-Aero I/O Connectors to Board-Level Applications

AlphaLink® • Nanominiature • Well-Master 260® • Micro-Crimp™

ALPHALINK™ BOARD-LEVEL SPRING-LOADED-CONTACT CONNECTORS AND FLEX JUMPERS



- Solderless termination
- PC tail and solder cup versions offer easy termination to flex or wire
- Turnkey I/O-to-board flex and pigtail wire jumpers
- Lightweight and low-profile—up to 40% space savings compared to 2mm pitch solutions
- High-density .050" center-to-center contact footprint
- Fast PC board integration with reduced board preparation and masking
- Withstands temperature, vibration and shock extremes

NANOMINIATURE CIRCULAR CONNECTORS

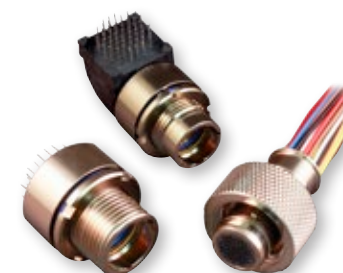

- Breakaway and threaded coupling, straight and 90° versions
- 1 Amp current rating
- .025 Inch (0.64 mm) contact spacing
- #30 And #32 gage wire accommodation
- Metal shell, aluminum, titanium or stainless steel
- Gold alloy TwistPin contact system
- Thru-hole and surface-mount PCB versions

WELL-MASTER® 260° HIGH-TEMPERATURE MICRO-D



- +260°C operating temperature
- Angled mounting ears to fit in small diameter instruments
- High reliability TwistPin contact system with special high temperature alloy
- .050" Pitch contact spacing for reduced size
- Solder cup, pre-wired or PCB

SERIES 79 MICRO-CRIMP ADVANCED PERFORMANCE CRIMP-CONTACT CONNECTORS

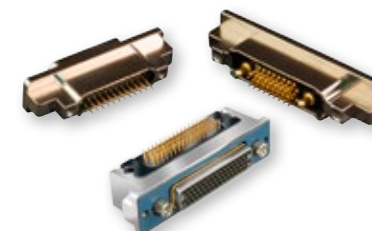

- Crimp, PCB, fiber optic, coax, power and pitot
- Precision machined aluminum shells sealed to IP67
- High-density #23 contact arrangements set on .076 centers
- Blind mating for rack and panel applications
- Environmental, hermetic and filter versions
- Integrated ground spring for improved EMI shielding



Advancing Power Connector and Cable Electrical Performance

From our unique high-performance LouverBand contact to the extreme environment PowerTrip™ connector series to TurboFlex™, the industry's most flexible power cable, no other interconnect manufacturer in the world offers such a broad range of advanced interconnect solutions for harsh-environment industrial, rail, and mil-aero power applications.



▲ Ultra-flexible TurboFlex® cable is ideally suited for applications where tight spacing and unusual routing meet the need for high-power, high-reliability performance, as in the multibranch pylon assembly above. Duraelectric™ jacketing provides harsh-environment protection and is available in multiple colors including safety orange. Cable assemblies can be overmolded in multiple colors to facilitate wire routing.

Advancing Power Connector and Cable Electrical Performance

PowerTrip™ • Super ITS™ • TurboFlex®

Glenair turnkey Duraelectric™ overmolded cable assemblies provide:

- Ultra-flexible routing/cable entry
- Waterproof sealing
- Robust mechanical protection
- Harsh chemical protection
- Electrical isolation and insulation
- Reduced wear damage



POWERTRIP™: THE POWER CONNECTOR FOR EXTREME ENVIRONMENTS



- Fast, easy mating with triple-start ACME thread: 360° turn for full mating
- Reduced size and weight compared to 5015/VG95234 solutions
- LouverBand sockets for improved current ratings and longer life, up to 2000 mating cycles
- Splined backshell interface for improved backshell attachment and EMI shielding
- Ratcheting coupling nut for secure mating
- Operating temperature -65° C to +200° C
- Hermetic and filter options available

SUPER ITS ULTRA HIGH-PERFORMANCE REVERSE-BAYONET POWER CONNECTORS



- Low insertion force, high-ampacity front-release contacts
- Rigid insulator with internal retention clip
- Aluminum, stainless steel or marine bronze shells with polarization keys
- Connector O-ring and individual wire sealing grommets
- High temperature range: -55° to +180°C
- 2000 mating cycles

TURBOFLEX® ULTRA-FLEXIBLE POWER CABLE AND ASSEMBLIES WITH DURALECTRIC™ JACKETING



- Ultra-flexible rope lay construction
- Available in a broad range of gages, 16 AWG to 450 MCM
- In-stock and available for immediate, same-day shipment with no minimums
- Duraelectric™ jacketing is suited for immersion, chemical or caustic fluid exposure, temperature extremes, UV radiation and more
- Coming soon: Lightweight aluminum core nickel-plated wire



Innovative Wire Protection and Connector Mating Technologies

Guardian • Hat Trick • MasterLatch® • MouseBud™

Field-Installable, Flexible Wire Protection

THE GUARDIAN CONDUIT SYSTEM FOR ANNULAR POLYMER-CORE CONDUIT



- Economical and easy to install
- General duty, all-purpose wire protection
- O-ring equipped environmental sealing (splash-proof)
- Self-locking coupling nuts
- Band and shrink-boot ready
- Metal and composite thermoplastic materials

THE HAT TRICK CONDUIT SYSTEM FOR HELICAL POLYMER-CORE CONDUIT



- Unique 3-in-1 fittings provide conduit attachment, shield termination, and boot attachment
- Composite thermoplastic and aluminum versions
- Fast, easy, reliable banding with Band-Master ATS® shield termination system
- Add a Full Nelson shrink boot for IP66-rated environmental sealing

Fast, Reliable, Tool-Free Mating

MASTERLATCH® QUICK-DISCONNECT MICRO-D



- Precision latch meets MIL-DTL-83513 vibration and shock
- The single thumb latch actuates a pair of locking latches that mate quickly and reliably to GMLM receptacles
- Low insertion force TwistPin contacts
- Easy-to-activate latching mechanism
- 6 different contact arrangements, 9 – 37 contacts
- Ergonomic latching mechanism easily activated even in tight spaces

MOUSEBUD™ SNAP-LOCK, TRIGGER-RELEASE CONNECTOR FOR ULTRA LOW-PROFILE APPLICATIONS



- Self-locking auto-coupling, trigger-release mechanism
- Spring-loaded pins for extended durability and easy cleaning
- One meter, one hour water immersion
- 2000 cycles mechanical life
- High-speed data, power, video, and audio applications
- Meets MIL-STD-810G shock, vibration, immersion
- EMI protected with integral backshell and ground spring
- Ultra low-profile and lightweight

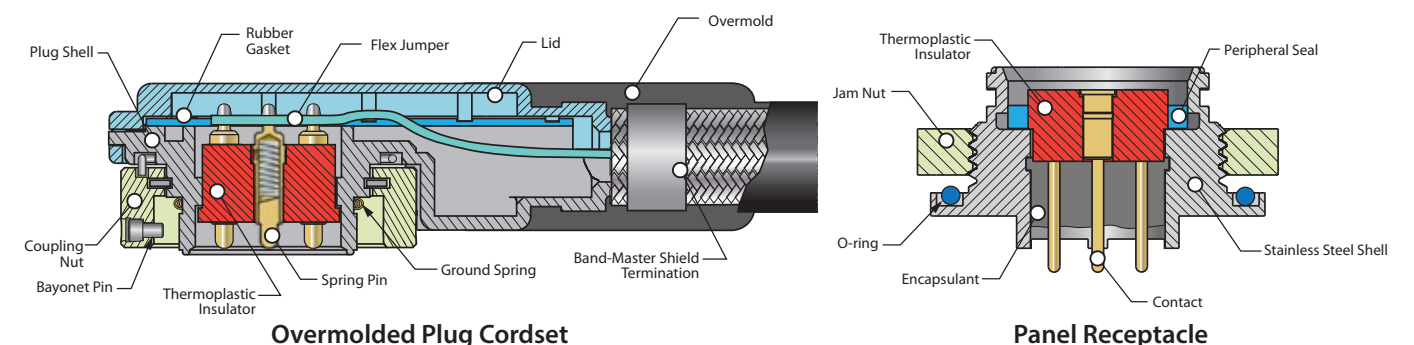

Glenair MouseBud snap-lock, trigger-release connectors feature a spring-loaded contact system for excellent resistance to damage and debris entrapment. The biased plunger is machined from solid copper alloy for improved strength, durability, and electrical performance compared to plungers drawn from sheet metal.

MouseBud Specifications

MouseBud Specifications	
Voltage rating / Current rating	500 VAC / 5 Amps
Contact resistance	20 milliohms maximum
Plug-to-receptacle ground resistance	<5 milliohm
Maximum wire size	#24 AWG
Insulation resistance	5000 megohms min.
Water immersion	MIL-STD-810 Method 512, 1m for 1 hr.
Durability	2000 mating cycles
Corrosion resistance	1000 hours
Sine vibration	EIA-364-28 condition IV, 20g peak
Random vibration	EIA-364-28 condition V letter H, 29g rms
Shock	EIA-364-27 condition D, 300g peak
EMI shielding effectiveness	40 dB minimum to 10 GHz

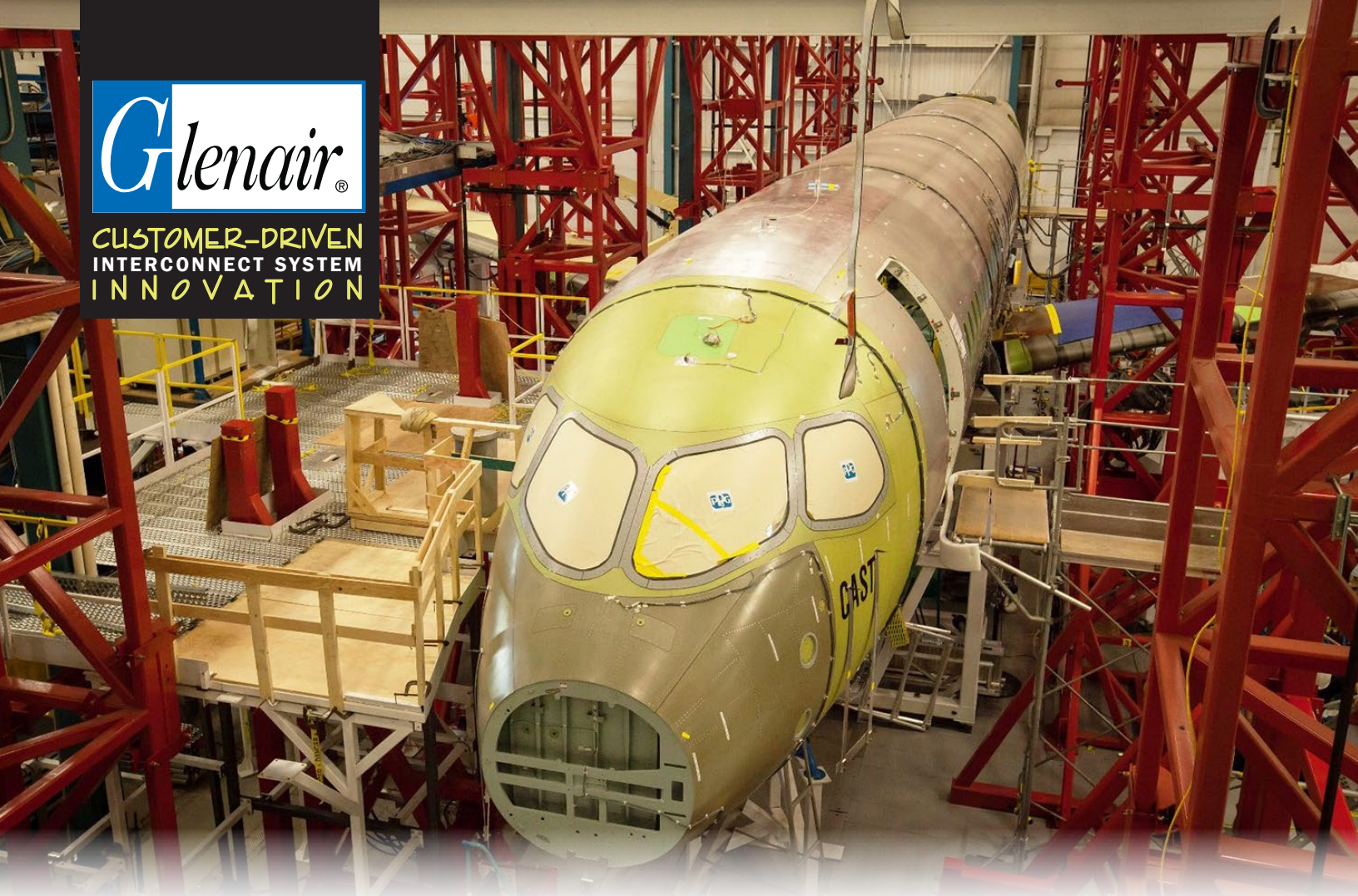

Reducing the Weight and Improving the Performance of Shield Termination Devices

Piggyback Boots • Swing-Arm™ • StarShield™ • Band-Master ATS®

EMI/RFI SHIELD TERMINATION COMPONENTS



Band-Master™ ATS provides quick, easy, cost-effective and reliable termination of metallic shielding or fabric braid to connectors and backshells.

- Precision hand-held tool and bands deliver reliable, repeatable performance
- Single piece stainless steel bands in various sizes and lengths
- Clamp both small and large diameters easily and reliably
- Pneumatic banding tool for high-speed mass production
- Qualified for both military and commercial aviation

Metal and composite solutions

Glenair is the world leader in the supply of shield termination backshell technology to the aerospace industry. Our expertise extends from conventional conductive metal-shell solutions to innovative lightweight composite solutions such as the Swing-Arm with its integrated EMI/RFI shield sock or special Do-Drop-In insert.

Reducing the Weight and Improving the Performance of Shield Termination Devices

Glenair innovations in composite thermoplastic materials and unique backshell assemblies optimize shield termination performance



▲ The Swing-Arm™ is a unique 3-in-1 backshell that provides straight, 45°, or 90° cable routing—all in one part; reducing BOM part number proliferation. The version above integrates a lightweight metal-clad composite braid sock for reliable shield termination.

KEY TECHNOLOGY: GLENAIR SWING-ARM FOR OVERALL SHIELD TERMINATIONS

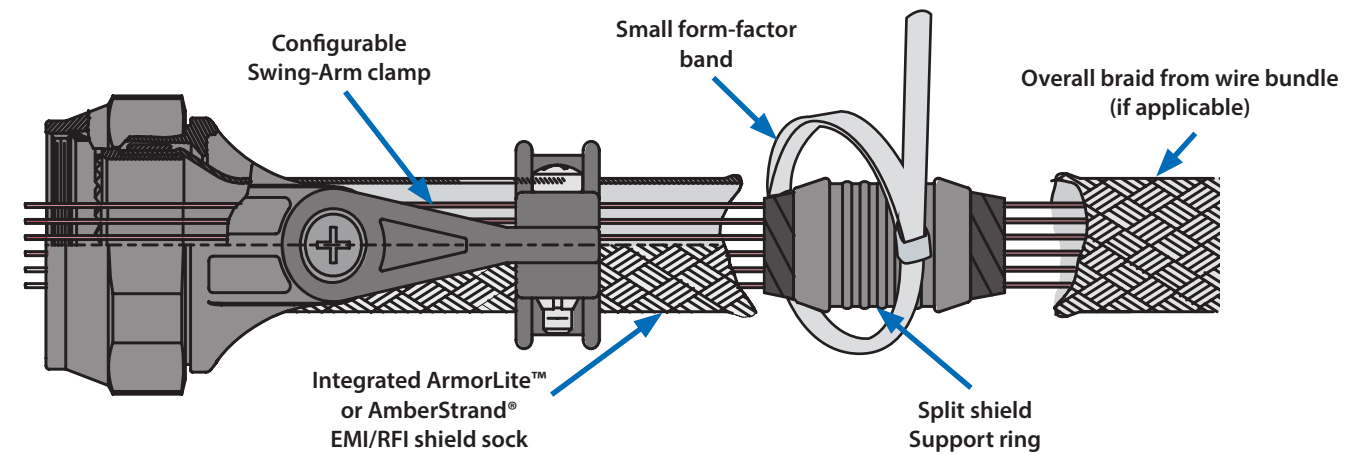

KEY TECHNOLOGY: GLENAIR STARSHIELD FOR INDIVIDUAL SHIELDED WIRE TERMINATIONS

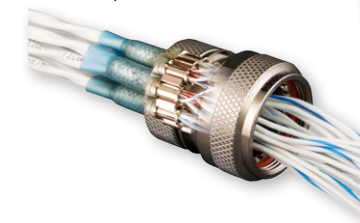

Composite and metal versions available

- Eliminates “standing antenna” problems common with pigtail shield termination systems
- Utilizes heat shrink termination (HST) sleeve technology for fast and reliable shield termination—even with dissimilar wire types/gauges
- Available in a standard configuration featuring a threaded compression nut and a tapered split-ring that fits snugly into a conical backshell or a lightweight split banding version.

PIGGYBACK SHRINK BOOT ADAPTERS: THE NO GUESSWORK, SMARTER, FASTER SHRINK BOOT



- Partially-recovered shrink boot, pre-attached to composite or metal shell connector adapter
- Reliable, first-time-every-time performance
- Up to 50% reduction in hand-labor and time
- EMI shield termination realized with drop-in banding porch, integrated shield sock, or Band-in-a-Can version

Innovation

A number of us are currently reading Walter Isaacson's book, *The Innovators*, in which he chronicles the many collaborative success stories from the world of digital technology. The collaboration theme highlighted in the life stories of Steve Jobs, Bill Gates and others is absolutely key to the business of innovation. Happily, it is a spirit and style I see every day here at Glenair.

I love this quote from Jack Kilby of TI, who consistently shared credit for creating the microchip and the digital evolution it spawned, even as the pundits endeavored to label him as the invention's godfather. He said, "When I hear that kind of thing, it reminds me of what the beaver told the rabbit as they stood at the base of Hoover Dam: 'No, I didn't build it myself, but it's based on an idea of mine'". The same thing happens constantly at Glenair. And I am always pleased to hear the members of our team work overtime to give each other due credit and recognition for their role.

This issue of *QwikConnect* highlights what we believe is a unique approach to R and D and subsequent new product development. In a nutshell, we tackle this work with an excitement and willingness to listen to our customers, combined with a business model that eliminates constraints. As we detail in the cover story, our experience has been that the key to maintaining velocity, flexibility and control in our business is not to ground our R and D projects on budgets, rigid timelines, or demands for immediate return on investment dollars—our model is to empower our organization with the right tools of the trade and cut them loose to address the real problems and challenges faced by our customers.

There are plenty of examples I could cite to demonstrate the fruits of this approach, but I would like to highlight one in particular: Our new Photonics unit is the absolute poster child of the Glenair model. In just a few short years we have embraced this new opportunity with a passion that is truly remarkable. Not only have we brought a complete range of viable new products to market—from fiber-to-copper media converters, photonic transceiver/receiver contacts and connectors and more—but in the process we have built out an impressive engineering and production operation that I am sure rivals any in the business. And talk about listening to the customer, our Photonics team has become a hub for a wide range of innovative work that spans far beyond the opto-electronic technology that was their original brief. Bravo!

One final note, we speak often at Glenair about "looking outside the bubble." Whenever you look outside our world to the scientific discoveries of other industries and disciplines, or simply open your eyes to the wonders of nature, you engage in the wise practice of pursuing knowledge wherever it may be found. Ingenuity and the drive to innovate have become hallmarks at Glenair. I would like to encourage everyone at Glenair to continue to reach beyond the boundaries of our interconnect world to appreciate the many miracles of discovery that are waiting to be found in disciplines beside our own.

Chris Toomey

Publisher

Christopher J. Toomey

Executive Editor

Carl Foote

Managing Editor

Marcus Kaufman

Editor/Art Director

Mike Borgsdorf

Graphic Designer

George Ramirez

Technical Consultant

Jim Donaldson

Issue Contributors

Lisa Amling
Deniz Armani
Peter Bialobrzdeski
Paul Bougie
Greg Cameron
Ken Cerniak
Davide Guglielmo
Ralph Hays
Joseph Hsiung
Guido Hunziker
Ron Logan
Sheila Melcher
Greg Noll
Jim Plessas
Giorgio Salvatore
Ramzi Sawires
Chris VanSoest
Fred Van Wyk

Distribution

Terry White

QwikConnect is published quarterly by Glenair, Inc. and printed in the U.S.A. All rights reserved. © Copyright 2015 Glenair, Inc. A complete archive of past issues of QwikConnect is available on the Internet at www.glenair.com/qwikconnect

GLENNAIR, INC.

1211 AIR WAY
GLENDALE, CA 91201-2497
TEL: 818-247-6000
FAX: 818-500-9912
E-MAIL: sales@glenair.com
www.glenair.com

