

MISSION-CRITICAL
INTERCONNECT
SOLUTIONS

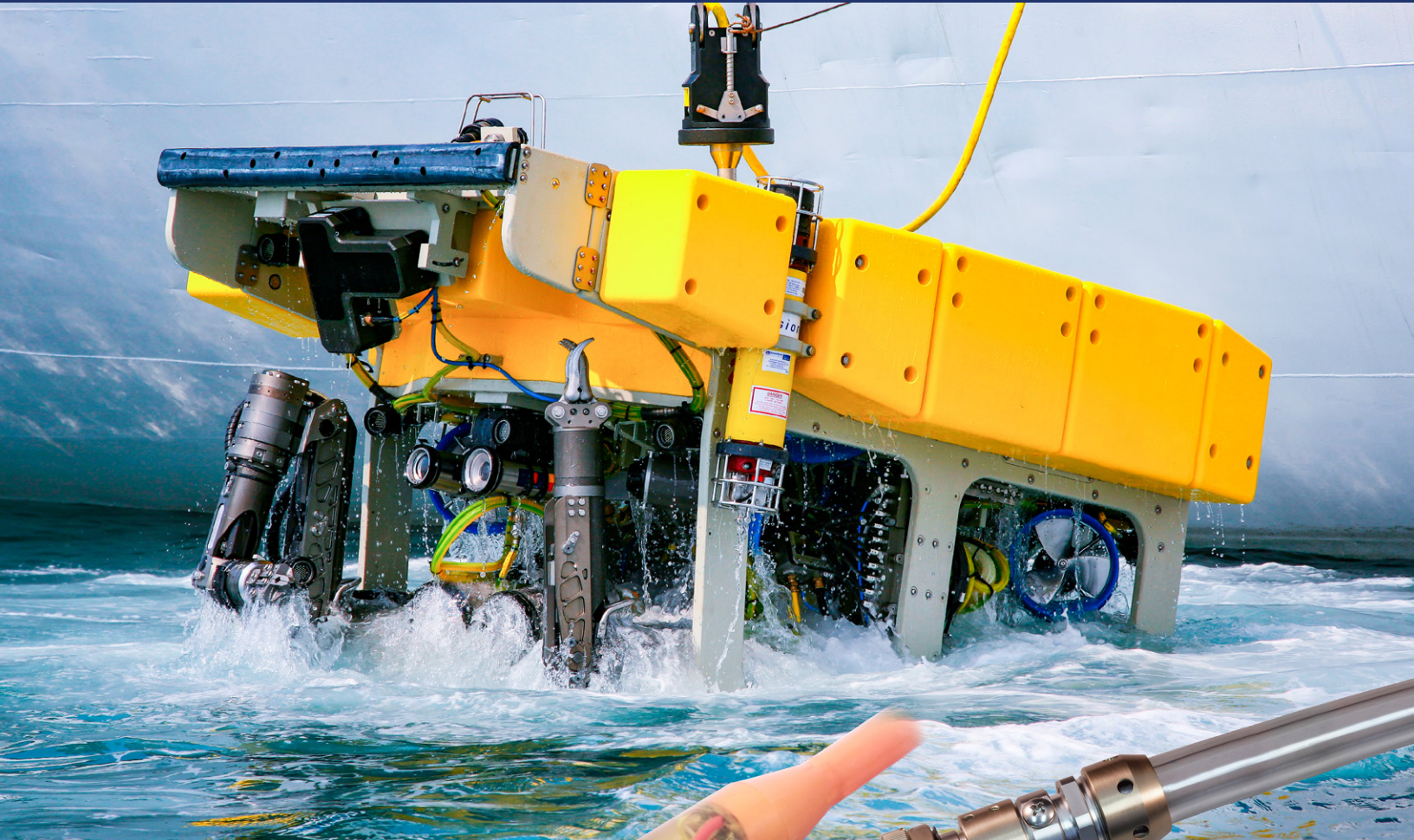

Glenair
SIGNATURE SERIES



Underwater Connectors

Dry-Mate Subsea Connectors and PBOF Assemblies for
High-Pressure Oil & Gas Industry Interconnect Applications

JULY 2022



OIL & GAS INDUSTRY INTERCONNECT SOLUTIONS

- High-pressure, 10K PSI open-face subsea
- Ruggedized serial, high-speed, fiber optic, and power submersible connectors
- Ultra high-density solutions for ROVs and inline inspection applications
- Overmolded cable and PBOF assemblies



High-performance, high-pressure interconnect technologies with proven sealing performance in shipboard, downhole and underwater applications





Glenair
SIGNATURE SERIES



Well-Master **260**

DEEP WATER SUBSEA, HIGH-PRESSURE 10K PSI / 700 BAR / 7000M CONNECTORS



SeaKing™ 700 10K PSI subsea connectors and cables



SeaKing™ PBOF assemblies, fittings, and accessories



SeaKing™ PEEK corrosion-free for anti-cathodic delamination applications

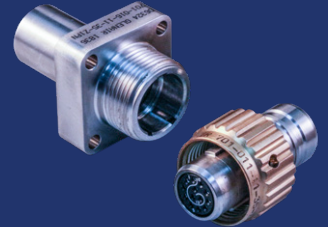

SeaKing Junior high-density small form-factor subsea connector

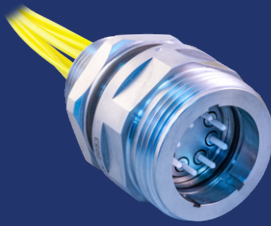

SeaKing Fiber open-face pressure-rated fiber optic connectors and cables



SeaKing™ POWER underwater primary power junction connectors

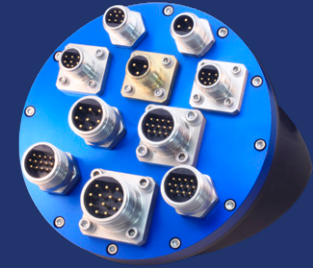

SuperG55™ dry-mate 10K PSI subsea electrical connectors

PIPELINE INSPECTION / ULTRAMINIATURE SUBSEA



Micro PSI microminiature high-pressure connectors and cables



SHALLOW WATER SUBSEA CONNECTORS



AquaMouse™ 3500 PSI miniature connectors and overmolded cables



Geo-Marine® 5000 PSI connectors and overmolded cables



DOWNHOLE HIGH-TEMPERATURE / HIGH PRESSURE CONNECTORS



High Temperature/High Pressure (HTHP) penetrators and feedthroughs



Well-Master® high temperature Micro-D connectors



Hydrostatic Test Lab



Dry-mate Underwater/Subsea Connector Selection Guide

SIZE	CONNECTOR SERIES	RUGGEDNESS LEVEL	OPEN-FACE SEALING	DEPTH RATING
Large		3 Mission-Critical	Yes	10K PSI (700 Bar)
Standard		3 Mission-Critical	Yes	10K PSI (700 Bar)
		2 High-Reliability	Yes	10K PSI (700 Bar)
		2 High-Reliability	No	5K PSI (450 Bar)
Miniature		2 High-Reliability	No	10K PSI (700 Bar)
		1 General Duty Harsh-Environment	No	3.5KPSI (240 Bar)
Micro		3 Mission-Critical	Yes	10K PSI (700 Bar)



Dry-mate Underwater/Subsea Connector Selection Guide

SHELL MATERIALS	ELECTRICAL RATING	SHELL OD RANGE	CABLE / CONTACT TYPES	APPLICATIONS	NOTES
Super Duplex Stainless Steel or Titanium	5kV 350A Max	2.34" to 3.64"	Overmolded Solder	High-Voltage Power	API 16D and 17E-Compliant
Stainless Steel, Titanium, or PEEK	600VDC 3–10A,	1.15" to 2.14"	PBOF, Overmolded Solder	High-Speed Datalink, RF, Fiber Optic, Serial Databus, Low- Voltage Power	Glass-Sealed Contacts Dual O-Ring Sealing
Stainless Steel or PEEK Rubber Keyway	600VDC 5–18A	1.12" to 1.50"	PBOF, Overmolded Crimp, Solder	Serial Databus, Low-Voltage Power	55 Series Intermateable Full-Mate Inspection Port
Stainless Steel	500VDC 5–23A	1.03" to 2.03"	Overmolded Solder	Serial Databus, Low-Voltage Power	Arctic Coupling Nuts HTHP Pipeline Inspection
Stainless Steel or Titanium	500VDC 5–23A	.875" to 1.95"	Overmolded Crimp, Solder	High-Speed Datalink, RF, Serial Databus, Low- Voltage Power	High-Density From #12 to #30 AWG Wire Support
Stainless Steel or Marine Bronze	750VDC– 1800VDC 5–23A	.5" to 1.562"	Overmolded Crimp, Solder	High-Speed Datalink, RF, Serial Databus, Low- Voltage Power	From 1 –130 Glass- Sealed Contacts
Stainless Steel or Titanium	300VDC 3A	.25" to .32"	Prewired Pigtails, Cables Solder	High-Speed Datalink, Serial Databus, Low- Voltage Power	Glass- and Piston O-Ring Sealed Ethernet-Ready

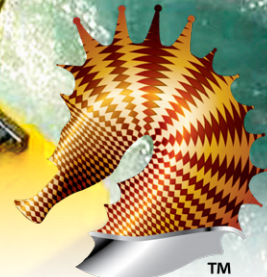
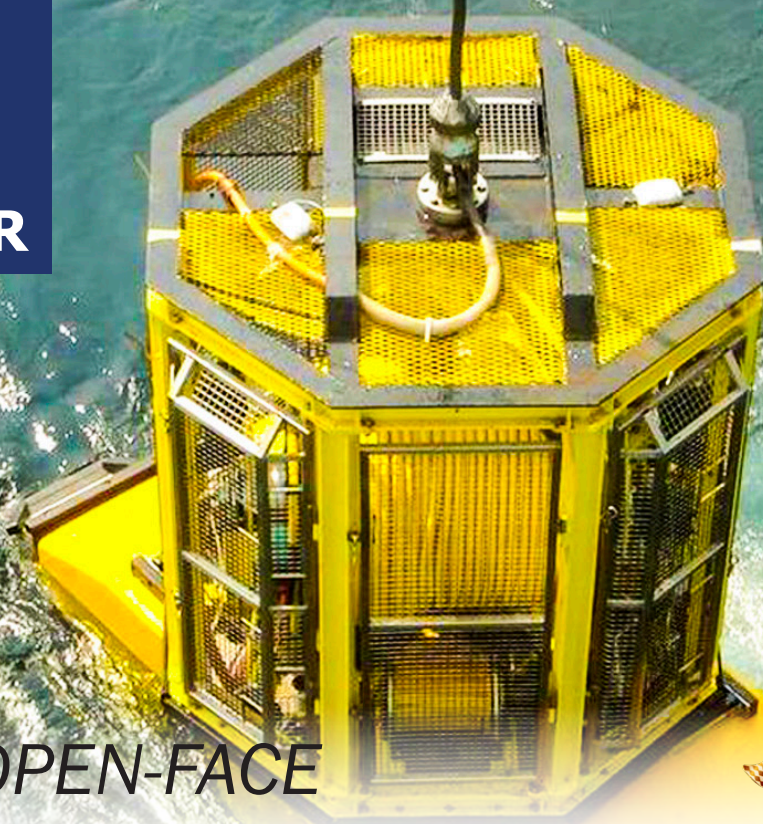

SeaKing
SEVEN HUNDRED

10K PSI OPEN-FACE SeaKing™ 700 Dry-Mate Underwater Connectors

10K PSI / 700 Bar / 7000m open-face or mated, dual O-ring equipped, high-density, high-voltage, fiber optic and hybrid electrical/optical subsea connectors

SeaKing is an innovative underwater connector series that eliminates a broad range of mechanical design weaknesses found in many of today's high-pressure subsea connector families. From its double O-ring seals and retractable engaging nut, to its multi-keyed mating interface, the SeaKing underwater connector represents a far more reliable approach to subsea power and signal connectivity.

Ideally suited for deep water offshore oil & gas, military/defense, oceanographic research, and other harsh-environment subsea applications, the dry-mate connector series is built for optimal durability and reliability. Tested to 15,000 PSI (open face and mated), and equipped with integrated dual O-ring seals, marine bronze coupling nuts, corrosion-resistant stainless steel shells and high-pressure contact inserts with gold-plated signal contacts, special RF and fiber optic solutions, the Series 700 SeaKing is today's most advanced high-density signal and standard-density power underwater connector.

- High density, small form-factor connector
- Dual O-ring seals ensure high-pressure performance for every leak path
- Signal, power, RF and optical insert arrangements
- Stainless steel with anti-galling marine bronze engaging nut, or cathodic delamination-free PEEK
- Full-mate inspection ports
- Easy O-ring replacement
- Key and keyway polarization

STANDARD CONFIGURATIONS

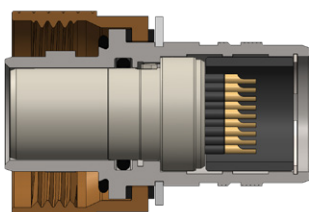

Cable Connector Plug (CCP)

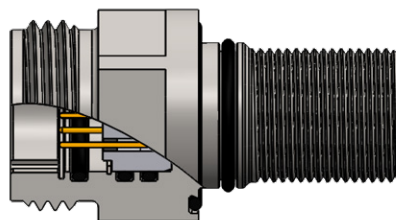

Bulkhead Connector Receptacle (BCR)

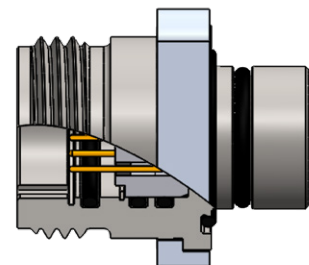

Flange Connector Receptacle (FCR)



SERIES 700 10K PSI / 700 BAR / 7000 M
**SeaKing™ High-Pressure Underwater
 Connectors, Cables, and PBOF Assemblies**
 Key mechanical and environmental features



Sealing: SeaKing 700 is the best-sealed subsea connector on the market. All critical interfaces, including bulkhead seals, glass-to-metal insert seals, mating interface bore seals, and face seals are fully redundant ensuring 10K PSI protection, even in the event of a single-seal failure.

Mating: SeaKing utilizes a modified UNC (coarse) mating interface with added clearance to reduce bio-fouling and facilitate rapid-advance mating. The marine bronze coupler on the plug is equipped with thread flats as well as knurling and is less susceptible to galling than standard steel engaging nuts. Polarized keys and keyways prevent both thread damage and mismatching.

Ease-of-Use: Multiple PBOF backshell indexing points, indexable flange FCRs, full-mate inspection ports, retractable engaging nuts, and other features make SeaKing the most user-friendly subsea connector on the market.

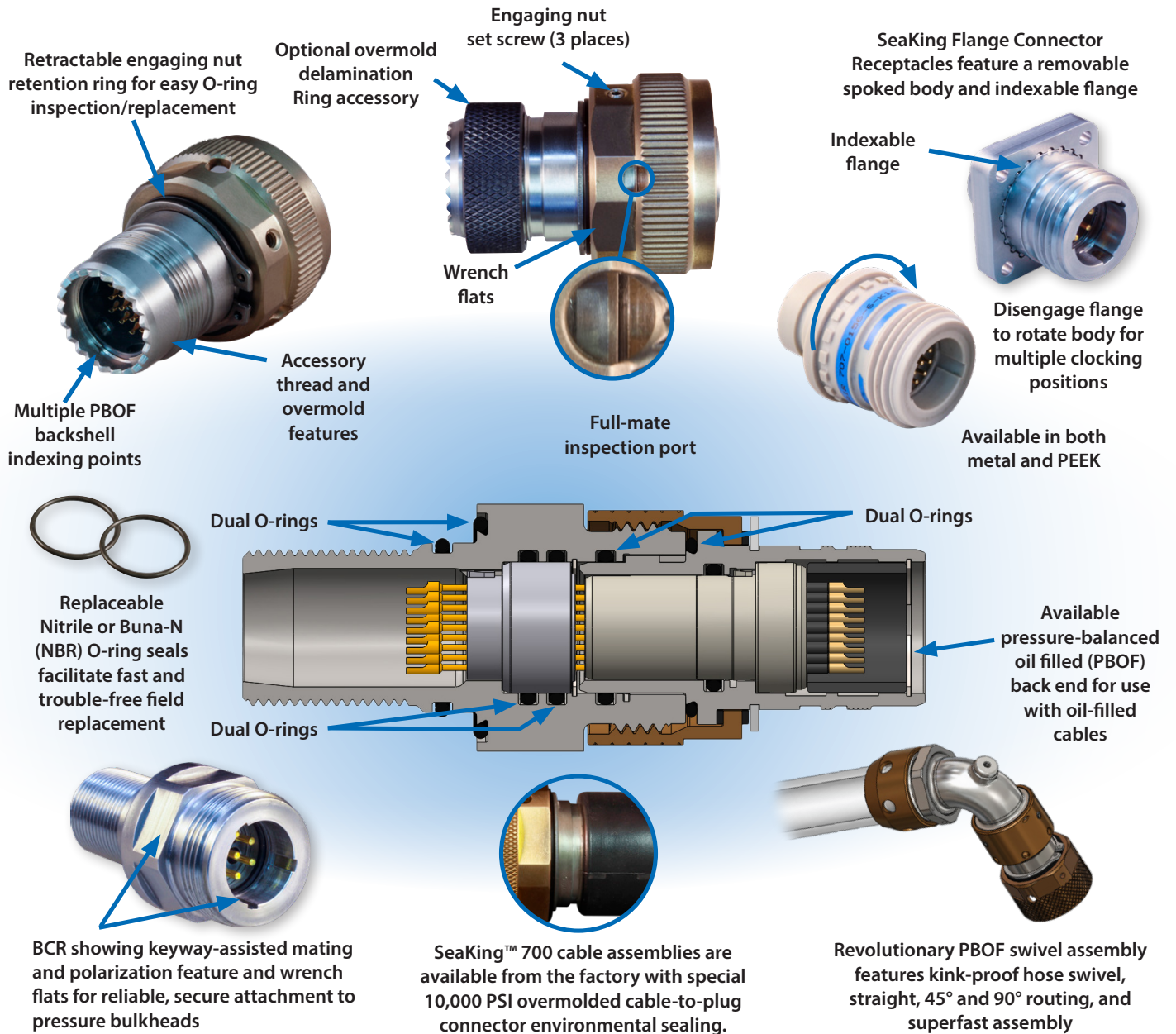



SERIES 70 10K PSI / 700 BAR / 7000 M

SeaKing™ High-Pressure Subsea Connectors, Cables, and PBOF Assemblies



Contact arrangements and specifications

SEAKING™ CONTACT ARRANGEMENTS Mating face view of pin insert (socket insert IDs are reversed)

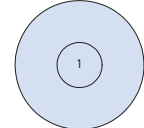
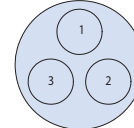
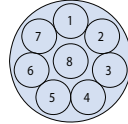
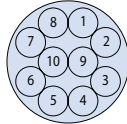
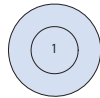
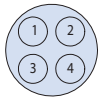

Size E		Size G			
E4	E1	G10	G8	G3	GC
4 Size #22 Contacts	1 Size #16 Contact	10 Size #22 Contacts	8 Size #20 Contacts	3 #16 Contacts	1 Coax Contact

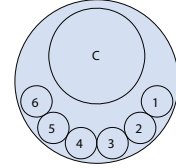
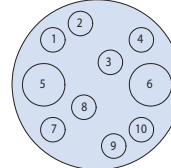
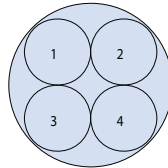
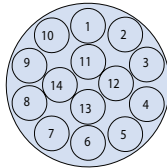
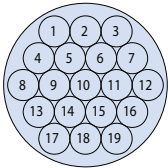

Size K				
K19	K14	K4	KX10	KC6
19 Size #22 Contacts	14 Size #20 Contacts	4 Size #16 Contacts	2 #16 Contacts, 8 #22 Contacts	Single 75 Ohm Coax, 6 #22 Contacts

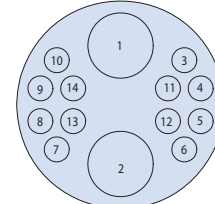
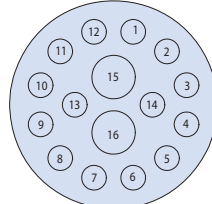
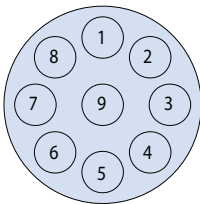

Size L		
L9	LX16	LX14
9 Size #16 Contacts	14 #22 Contacts 2 #16 Contacts	2 #12 Contacts 12 #22 Contacts

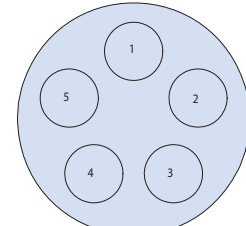
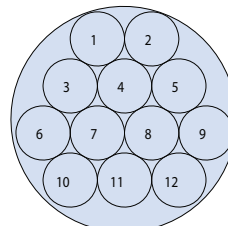
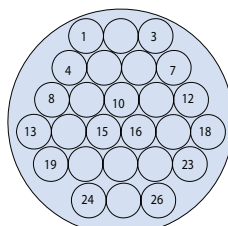
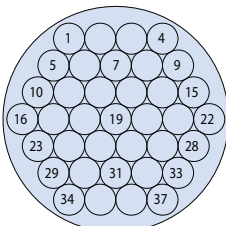

Size M			
M37	M26	M12	M5
37 Size #22 Contacts	26 Size #20 Contacts	12 Size #16 Contacts	5 #12 Contacts 850VDC / 600VAC



SERIES 70 10K PSI / 700 BAR / 7000 M

SeaKing™ High-Pressure Subsea Connectors, Cables, and PBOF Assemblies



Contact arrangements and specifications

Consult factory for custom insert arrangements including a wide range of shielded RF microwave and high frequency contact configurations

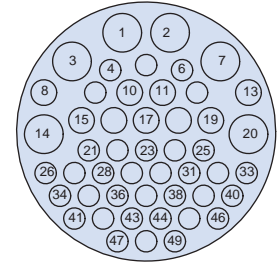
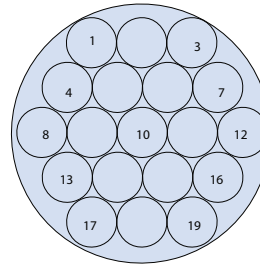
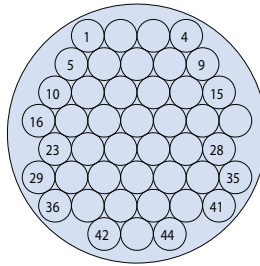
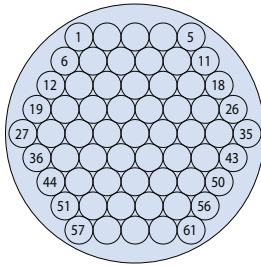

Size O

O61

61 Size #22
Contacts

O44

44 Size #20
Contacts

O19

19 Size #16
Contacts

OX49

49 Contacts
6 #16 • 9 #20 • 34 #22

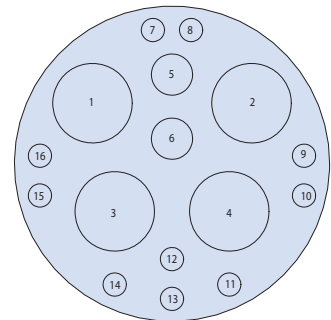
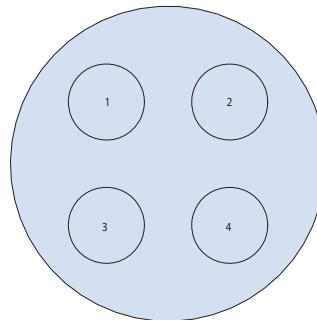
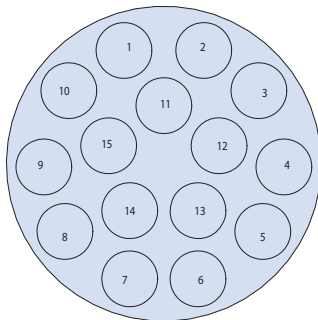

Size P

P15

15 Size #12
Contacts

P4

4 Size #8 Contacts
1kV

PX16

16 Contacts
4 #8 • 2 #16 • 10 #22

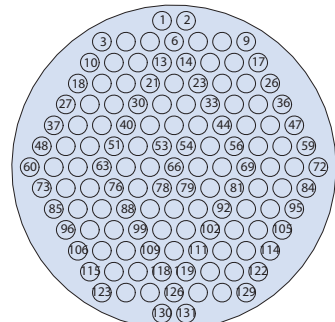
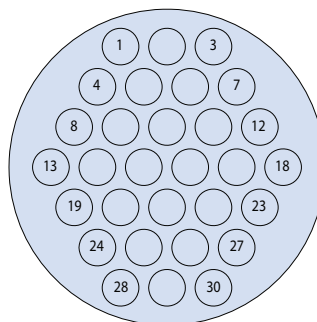
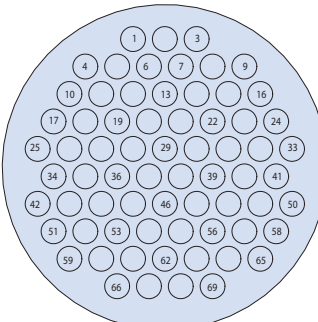
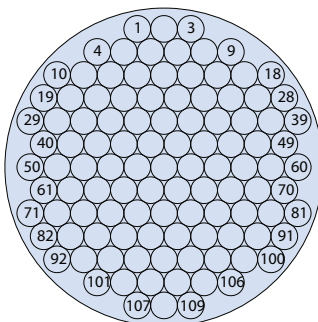

Size Q

Q109

109 Size #22
Contacts

Q69

69 Size #20
Contacts

Q30

30 Size #16
Contacts

Size R

R131

131 Size #22
Contacts



SERIES 70 10K PSI / 700 BAR / 7000 M

SeaKing™ High-Pressure Subsea Connectors, Cables, and PBOF Assemblies



Contact arrangements and specifications

SEAKING™ FIBER OPTIC AND HYBRID FIBER-ELECTRICAL ARRANGEMENTS Mating face view of pin insert (socket insert IDs are reversed)

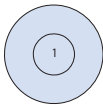

Size E

EF1

1 Fiber Terminus

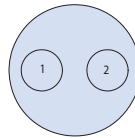

Size K

KF2

2 Fiber Termini

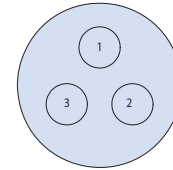

Size L

LF3

3 Fiber Termini

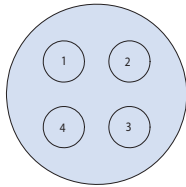

Size M

MF4

4 Fiber Termini

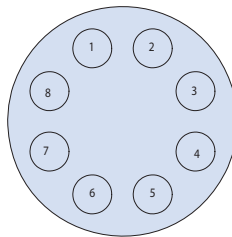

Size O

OF8

8 Fiber Termini

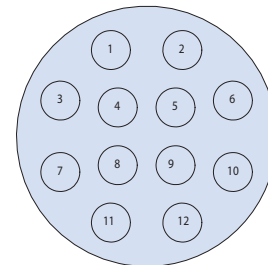

Size P

PF12

12 Fiber Termini

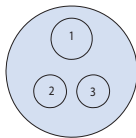

Size K

KH12

1 Fiber Terminus
2 #16 Contacts

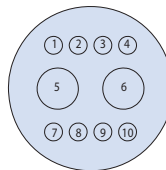

Size L

LH28

2 Fiber Termini
8 #22 Contacts

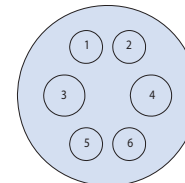

Size M

MH24

2 Fiber Termini
4 #16 Contacts

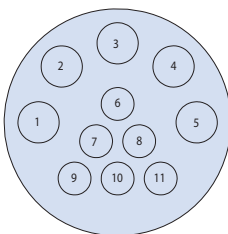

Size O

OH56

5 Fiber Termini
6 #16 Contacts

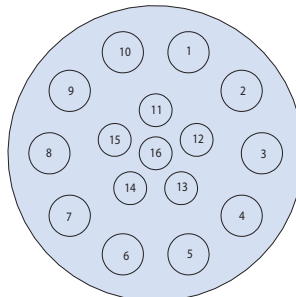

Size Q

QH106

10 Fiber Termini
6 #16 Contacts

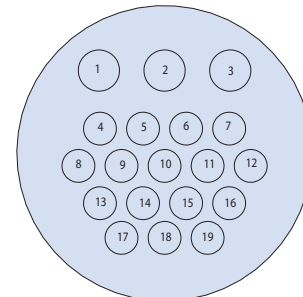

QH316

3 Fiber Termini
16 #16 Contacts



SERIES 70 10K PSI / 700 BAR / 7000 M

SeaKing™ High-Pressure Subsea Connectors, Cables, and PBOF Assemblies



Contact arrangements and specifications

Consult factory for custom insert arrangements including a wide range of shielded RF microwave and high frequency contact configurations

All high-density signal and standard-density power contact arrangements are available across the complete range of connector styles (CCP, FCR, and BCR). High-speed Ethernet inserts as well as Pressure Balanced Oil Filled (PBOF) configurations and a purpose-designed family of pressure caps, accessories and backshells are also available, please consult the factory.

SeaKing™ bulkhead connector receptacles (BCR) and flange connector receptacles (FCR) are equipped with high-pressure glass-to-metal sealed inserts with solder contact wire termination and 10K PSI open-face rating. Cable connector plugs (CCP) utilize environmental O-ring sealed inserts and are rated to 10K PSI in the mated condition.

Contact Arrangement Table							
Shell Size	Contact Size						
	#22	#20	#16	#12	#8	Fiber Optic	Hybrid
E	4		1			1	
G	10	8	3				1 Coax (only)
K	19	14	4			2	1 Coax • 6 #22 8 #22 • 2 #16 1 F/O • 2 #16
L			9			3	12 #22 • 2 #12 8 #22 • 2 #16 2 F/O • 8 #22
M	37	26	12	5		4	2 F/O • 4 #16
O	61	44	19			8	6 #16 • 9 #20 • 34 #22 5 F/O • 6 #16
P				15	4 (1kV)	12	4 #8 • 2 #16 • 10 #22
Q	109	69	30				10 F/O • 6 #16 3 F/O • 16 #16
R	131						

Current Rating (Amps)		
Contact Size	GRE Molded Inserts	Glass-to-Metal Sealed Inserts
#22	5 Amps	3 Amps
#20	7.5 Amps	5 Amps
#16	13 Amps	10 Amps
#12	23 Amps	17 Amps
#8	50 Amps	35 Amps

All contact arrangements are rated for 600 VDC / 400 VAC unless otherwise specified.
Solder cups are sized to accept maximum wire gauge according to the contact size

SeaKing™ Performance Specifications		
Pressure Rating	Plug: 10,000 PSI, mated condition Receptacles: 10,000 PSI mated and open face	per ISO 13628-6
Electrical	600 V typical 5 GOhm insulation resistance at 500 VDC	per MIL-STD-202, Method 301 per MIL-STD-202, Method 302
Materials	Salt Spray (corrosion) Humidity (steady state) Thermal Cycle	MIL-STD-202, Method 101 MIL-STD-202, Method 103 ISO 13628-6



SERIES 700 10K PSI / 700 BAR / 7000 M SeaKing™ High-Pressure Underwater Connectors, Cables, and PBOF Assemblies



700 Series connectors CCP, FCR and BCR



**700-001 CABLE CONNECTOR
PLUG (CCP) WITH SOLDER CUP
TERMINATION**



**700-006 GLASS-TO-METAL SEAL
OR 700-026 GLASS REINFORCED
EPOXY, FLANGE CONNECTOR
RECEPTACLE (FCR) WITH
SOLDER CUP TERMINATION**

SeaKing - How To Order						
Sample Part Number	700	-001	-K19	-Z1	S	N
Product Series	700 = SeaKing™					
Shell Style	001 = cable connector plug (CCP)					
Shell Size-Insert Arrangement	(See page 8 - 10)					
Shell Material	Z1 = 316 stainless steel TC = titanium					
Contact Style	S = socket					
Polarization	A, B, C, N = normal (see sales drawing for details)					

SeaKing - How To Order						
Sample Part Number	700	-006	-019	-Z1	P	N
Product Series	700 = SeaKing™					
Shell Style	006 = GTMS flange connector receptacle (FCR) 026 = GRE flange connector receptacle (FCR)					
Shell Size-Insert Arrangement	(See page 8 - 10)					
Shell Material	Z1 = 316 stainless steel TC = titanium					
Contact Style	P = Pin					
Polarization	A, B, C, N = normal (see sales drawing for details)					



**700-007 GLASS-TO-METAL
SEAL OR 700-027 GLASS
REINFORCED EPOXY,
BULKHEAD CONNECTOR
RECEPTACLE (BCR) WITH
SOLDER CUP TERMINATION**

**700-010 BULKHEAD CONNECTOR FEED-THRU (BCF),
INCONEL INSERT, 10K PSI OPEN FACE RATED**

SeaKing - How To Order						
Sample Part Number	700	-007	-K19	-Z1	P	N
Product Series	700 = SeaKing™					
Shell Style	007 = GTMS bulkhead connector receptacle (BCR) 027 = GRE bulkhead connector receptacle (BCR)					
Shell Size-Insert Arrangement	(See page 8 - 10)					
Shell Material	Z1 = 316 stainless steel TC = titanium					
Contact Style	P = pin					
Polarization	A, B, C, N = normal (see sales drawing for details)					

SeaKing - How To Order								
Sample Part Number	700-010	-M12	-Z1	P	N	P	N	-2
Product Series	700-010 = SeaKing™ bulkhead connector feed-thru (BCF)							
Shell Size-Insert Arrangement	(See page 8 - 10)							
Shell Material	Z1 = 316 stainless steel TC = titanium							
Side A, Contact Type	P = pin S = socket							
Side A, Polarization	A, B, C, N = normal (see polarization table, pgs. 6-7)							
Side B, Contact Type	P = pin S = socket							
Side B, Polarization	A, B, C, N = normal (see sales drawing for details)							
Bulkhead Thickness	1 = 1.00 - 1.50	2 = 1.50 - 2.00	3 = 2.00 - 2.500	4 = 2.50 - 3.00	5 = 3.00 - 3.50	6 = 3.50 - 4.00		



SERIES 700 10K PSI / 700 BAR / 7000 M SeaKing™ High-Pressure Underwater Connectors, Cables, and PBOF Assemblies



Single-ended connector receptacle pigtail assembly

7071-0012 FLANGE OR BULKHEAD CONNECTOR RECEPTACLE PIGTAIL ASSEMBLY

SeaKing - How To Order								
Sample Part Number	7071-0012		-1	M12	-Z1	-12	A	N
Product Series	7071-0012 = SeaKing™							
Receptacle Style	1 = 700-006 (GTMS FCR) 2 = 700-007 (GTMS BCR)							
	3 = 700-026 (GRE FCR) 4 = 700-027 (GRE BCR)							
Insert Arrangement	(See page 8 - 10)							
Material/Finish	Z1 = 316 stainless steel TC = titanium K = glass-reinforced PEEK							
Cable Length	In inches							
Wire Coloring	A = all white B = 10 color repeating; IAW MIL-STD-681							
Polarization	A, B, C, N = normal (see sales drawing for details)							

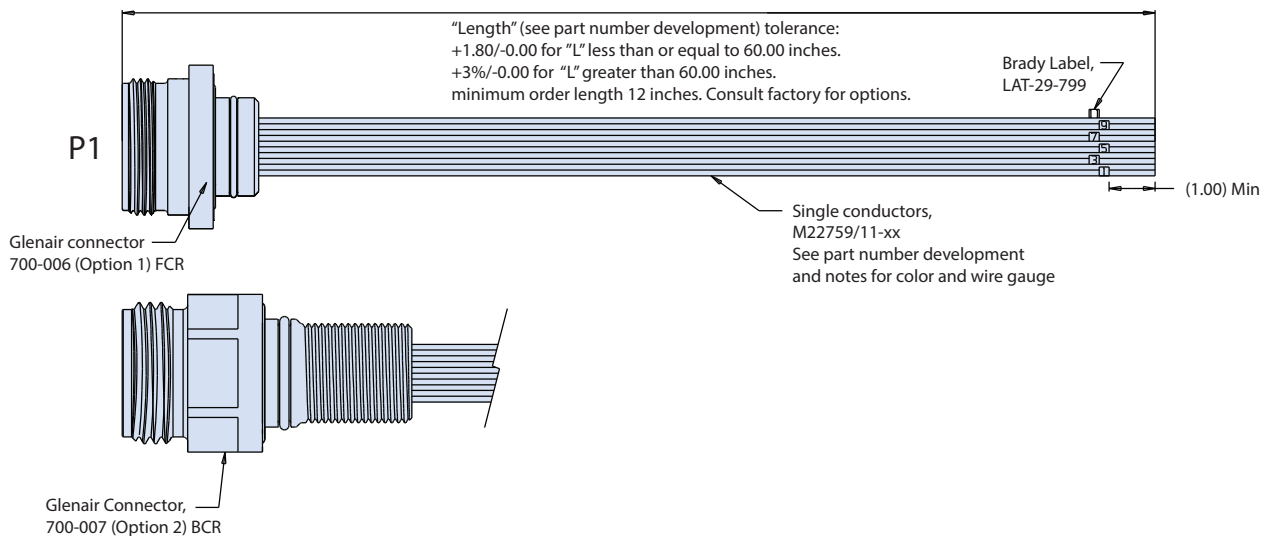

Alternate Key Positions		
Key Position	Key Rotation	
	A°	B°
Normal (N)	150°	210°
A	75°	210°
B	95°	230°
C	140°	275°

NOTES

- 100% electrically tested for shorts, dielectric withstanding voltage (500Vac 5 seconds max) and insulation resistance (conductor to conductor and conductor to shell at 500Vdc/200 megohms min. (IAW-STD-202, Method 302)
- Quantity and gauge of conductors determined by insert arrangement. All cavities to be populated with largest gauge wire.
- All solder cup cavities are isolated with M23053/8 heat shrink tubing.



SERIES 700 10K PSI / 700 BAR / 7000 M SeaKing™ High-Pressure Underwater Connectors, Cables, and PBOF Assemblies



Single ended or back-to-back, overmolded cable

SeaKing - How To Order								
Sample Part Number	7071-0007	-S	R	Z1	-K19	N	-24	11
Series	7071-0007 = SeaKing™ cable connector plug (CCP) assembly							
P1	R = right angle S = straight							
P2	R = right angle N=none S = straight							
Shell Material/Finish	Z1 = 316 stainless steel TC = titanium K = glass-reinforced PEEK							
Insert Arrangement	(See page 8 - 10)							
Polarization	A, B, C, N = normal (see sales drawing for details)							
Cable Length	In inches							
Cap Options	10, 11, 20, 21; omit for none							

Alternate Key Positions		
Key Position	Key Rotation	
	A°	B°
Normal (N)	150°	210°
A	75°	210°
B	95°	230°
C	140°	275°

Cap Options	
Sym	Description
10	Protective cap, no lanyard
11	Protective cap, with lanyard
20	Pressure cap, no lanyard
21	Pressure cap, with lanyard

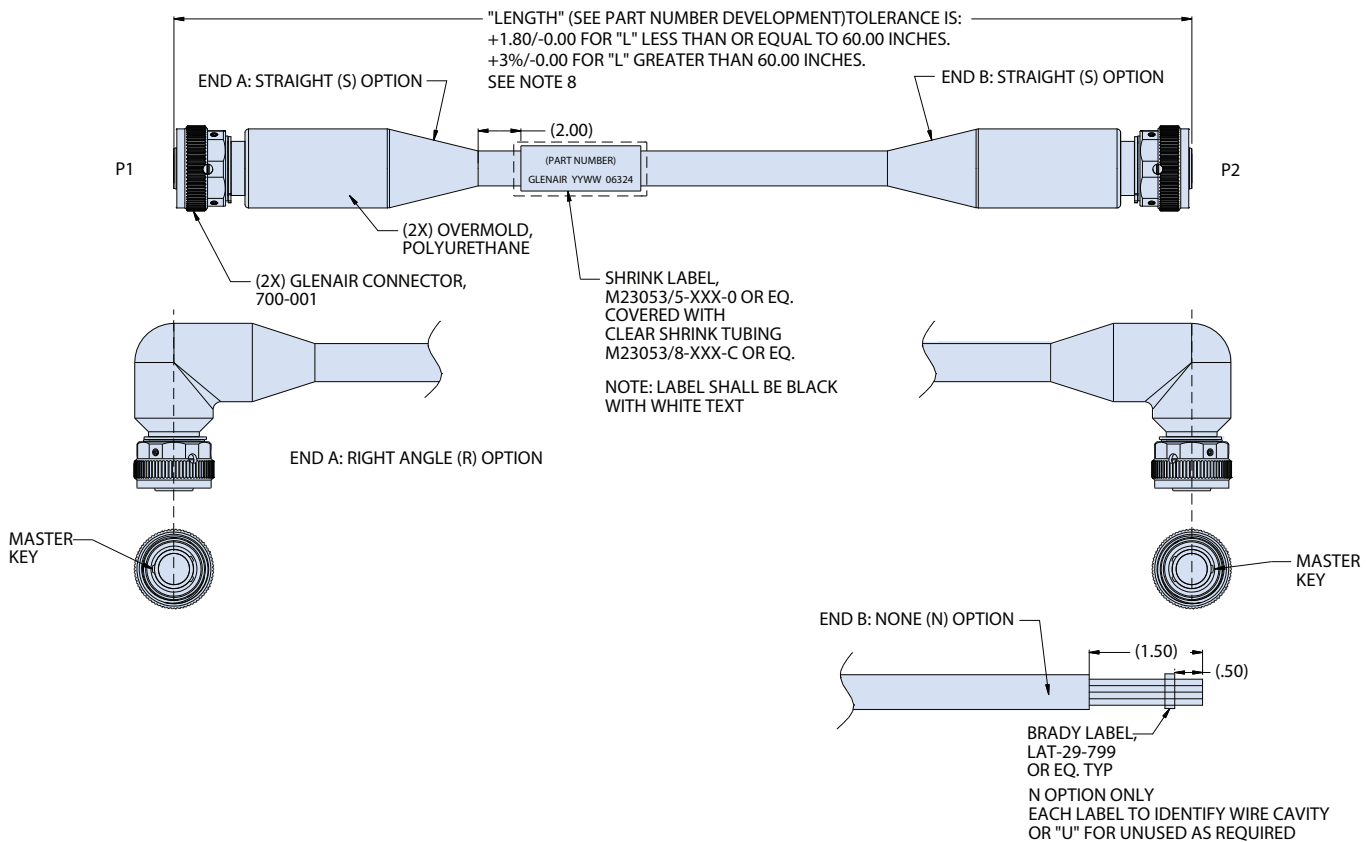



SERIES 700 10K PSI / 700 BAR / 7000 M SeaKing™ High-Pressure Underwater Connectors, Cables, and PBOF Assemblies



Single ended or back-to-back, overmolded cable

SIZE	A	B	C	D	E
E	4.55	0.765	2.88	2.93	2.165
G	4.55	0.875	2.94	3.11	2.235
K	4.55	1.00	3.00	3.16	2.105
L	4.55	1.125	3.00	3.29	2.165
M	5.05	1.250	3.38	3.43	2.18
O	5.05	1.500	3.5	3.55	2.05
P	5.05	1.625	3.68	3.75	2.125
Q	5.05	1.750	3.88	3.93	2.18
R	5.05	1.875	3.94	3.99	2.115

NOTES

- 100% electrically tested for shorts, dielectric withstanding voltage (at 500Vac 5 seconds max) and insulation resistance (conductor to conductor and conductor to shell) at 500Vdc/200 megohms min. IAW MIL-STD-202, Method 302).
- Unit pack: 1 ea. In poly bag, heat-sealed. Include dust cap. Tag and bag per illustration.
- Max pressure rating 10000 PSI.
- For connector dimensions, materials, finishes, refer to drawing 700-001.
- For insert arrangements refer to drawing 709-099 contact manufacturer for builds with combo insert arrangements.
- Double ended cordsets are wired one to one (ex. pin 1 to pin 1, 2 to 2 etc).
- Quantity and gauge of conductos determined by insert arrangement. All cavities to be populated with largest gauge wire.
- Marker label, M23053/5 or equivalent. Covered with clear tubing M@3053/18 or equivalent tubing shall be white with black text.
- Single conductors shall be identified with cavity identifier or "U" for unused marker label, M23053/ 5 or equivalent covered with clear tubing M23053/18 or equivalent tubing shall be white with text.
- Minimum order length is 24.00 inches. Consult factory for orders longer 1200 inches (100ft)
- All configurations are wired one to one.
- Pressure rated cable. Polyurethane jacket wire AWG shall be per contact size.

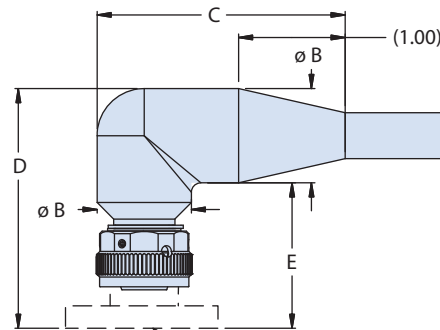
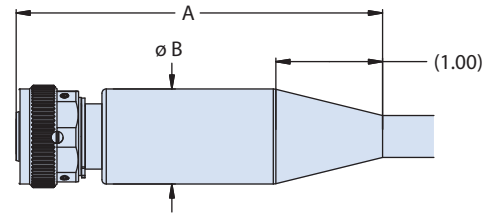

OUTLINE OF FLANGE CONNECTOR RECEPTACLE (FCR), 700-006.
NOTE:
CONNECTOR UP TO FLANGE SHOWN ONLY (REAR NOT SHOWN)



10K PSI OPEN-FACE SeaKing™ PBOF

Wired and connectorized
PBOF assemblies, fittings,
and accessories



WIRED / CONNECTORIZED PBOF CONDUIT ASSEMBLIES

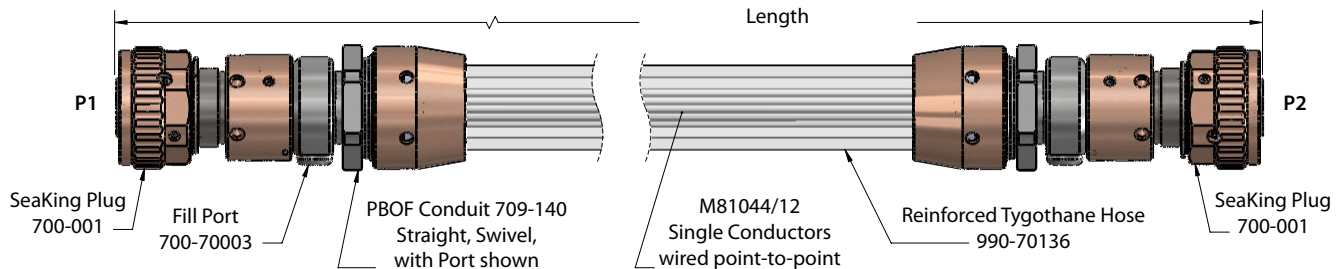

SeaKing PBOF Wired Assembly - How To Order						
Sample Part Number	7071-0348		-K19	-L1S	-L1S	-N -XXX
Base Part Number	7071-0348 = SeaKing™ PBOF wired assembly					
Insert Arrangement P1 and P2	G10, G8, K19, K14, K4, KC6, L9, M37, M26, M12, O61, O44, O19, OX49, Q109, Q30, R131 (see catalog or dwg 709-099 for details)					
End Configuration P1	Angle Option	Fill Port	Swivel/Fixed			
	L = Straight M = 45° N = 90°	1 = Yes 0 = No	S = Swivel F = Fixed			
End Configuration P2	Angle Option	Fill Port	Swivel/Fixed			
	L = Straight M = 45° N = 90°	1 = Yes 0 = No	S = Swivel F = Fixed			
Key Orientation	Key Position	A°		B°		
	N	150°		210°		
	A	75°		210°		
	B	95°		230°		
C	140°		275°			
Cable Length	in Inches					



SERIES 700 10K PSI / 700 BAR / 7000 M
SeaKing™ High-Pressure Underwater PBOF Assemblies, Fittings, and Accessories
 Boot seal assembly and unwired PBOF conduit



CONNECTOR / BACKSHELL / BOOT SEAL ASSEMBLY

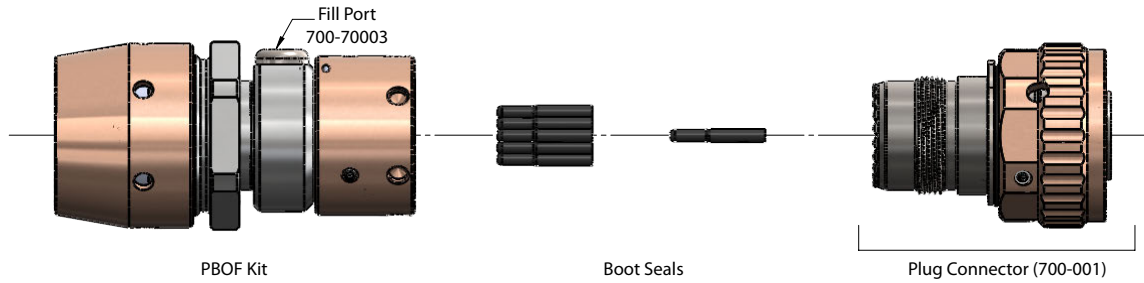

SeaKing PBOF Connector/Backshell/Boot Seal Assembly - How To Order						
Sample Part Number	707-0320	-K19	Z1	S	N	L1S
Base Part Number	707-0320 = SeaKing™ PBOF assembly					
Insert Arrangement	G10, G8, K19, K14, K4, KC6, L9, M37, M26, M12, O61, O44, O19, OX49, Q109, Q30, R131 (see catalog or dwg 709-099 for details)					
Barrel Material	Z1 = Stainless Steel TC = Titanium					
Contact Style	S = Socket					
Key Position	Key Position	A°	B°			
	N	150°	210°			
	A	75°	210°			
	B	95°	230°			
Configuration Options	Angle Option	Fill Port		Swivel/Fixed		
	L = Straight	1 = Yes		S = Swivel		
	M = 45°	0 = No		F = Fixed		
	N = 90°					

UNWIRED PBOF CONDUIT ASSEMBLIES

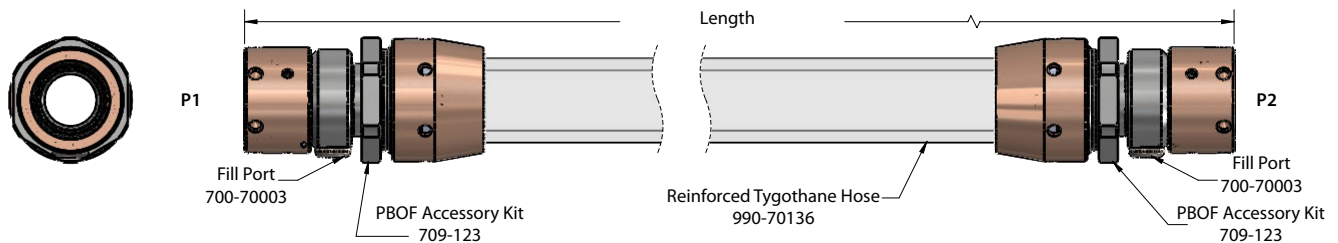

SeaKing PBOF Conduit Assembly - How To Order				
Sample Part Number	709-140	-K	-L1S	-XX
Base Part Number	709-140 = SeaKing™ PBOF conduit assembly			
Backshell and Tubing size	E, G, K, L, M, O, P, Q, R			
Backshell Configuration P1	Angle Option	Fill Port		Swivel/Fixed
	L = Straight	1 = Yes		S = Swivel
	M = 45°	0 = No		F = Fixed
Backshell Configuration P2	Angle Option	Fill Port		Swivel/Fixed
	L = Straight	1 = Yes		S = Swivel
	M = 45°	0 = No		F = Fixed
Cable Length	in Inches			



SERIES 700 10K PSI / 700 BAR / 7000 M SeaKing™ High-Pressure Underwater PBOF Assemblies, Fittings, and Accessories



Assembly fittings and accessories

REVOLUTIONARY PBOF SWIVEL HOSE ATTACHMENT ACCESSORIES

Hose barb fittings for PBOF assemblies are the perennial weak link in subsea oil & gas applications. Kinked and twisted hoses, leaky fittings, corroded hose clamps, and other performance problems characterize most existing solutions. The Glenair PBOF swivel hose attachment for SeaKing™ connectors solves these problems and more. Designed from the sea floor up to perform flawlessly and reliably, this revolutionary attachment puts an end to the long list of field maintenance problems associated with oil-filled cable applications.

- **Straight, 45°, and 90° “full radius” angle and profile hose routing**
- **Hose angle adjustment feature eliminates risk of oil leakage**
- **Corrosion-resistant materials used throughout**
- **Threaded couplers with safety set-screws for fail-safe leak and decoupling protection—no special tools required for assembly**
- **Compact PBOF compression fitting with 340° swivel action hose for an extra degree freedom of routing in compact situations**
- **Support for the broad range of hose diameters and wall thicknesses**

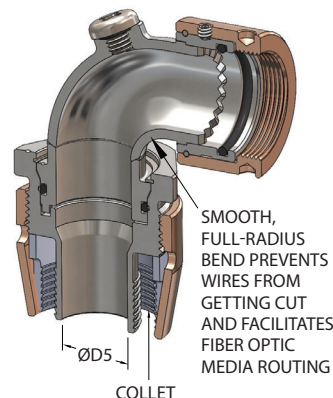

ACCESSORY TEETH MESH WITH TEETH ON BACK END OF PLUG ASSEMBLY, ALLOWING TUBING END OF PBOF TO BE Clocked IN DESIRED DIRECTION

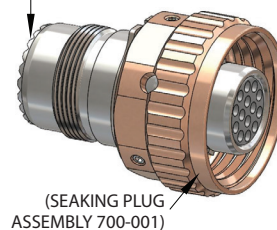

SeaKing PBOF Attachment Accessory Kits - How To Order					
Sample Part Number	709-123	K	-L	1	S
Product Series	709-123 = SeaKing™ PBOF accessory				
Shell Size	E, G, K, L, M, O, P, Q, R				
Angular Function	L = Straight M = 45° N = 90°				
Fill Port Option	0 = No fill port 1 = With fill port				
Swivel/Fixed Option	S = Swivel F = Fixed				

The complete range of SeaKing PBOF hose compression fittings includes straight, 45°, and 90° full radius profile versions; with and without integrated oil fill ports

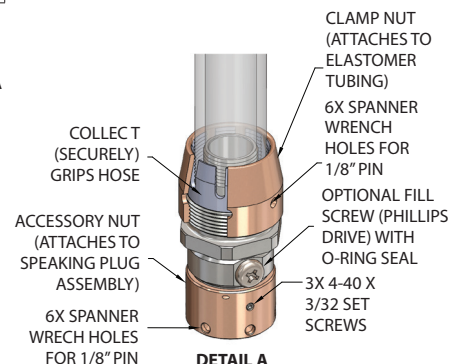
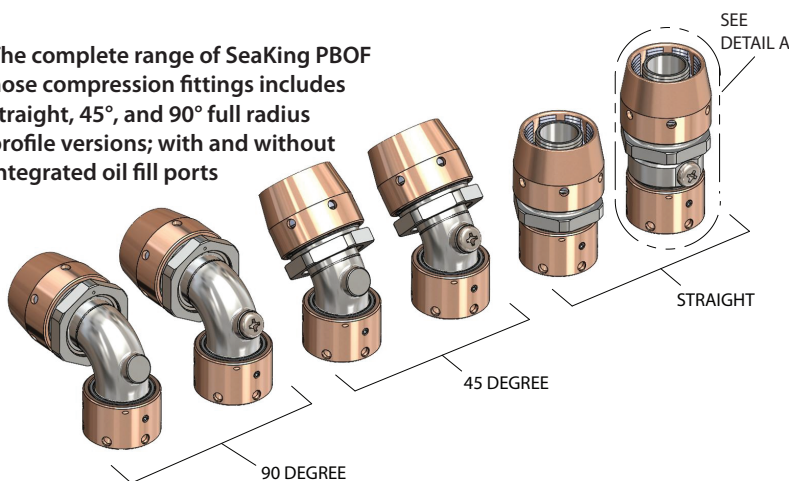



DEEP
WATER



COMPOSITE THERMOPLASTIC **SeaKing™ PEEK**

Glenair SeaKing Series 700 with 30% glass-filled PEEK composite thermoplastic shells for use in anti-cathodic delamination applications

SeaKing 700 is an innovative underwater connector series that eliminates a broad range of mechanical design weaknesses found in many of today's high-pressure subsea connector families. From its double O-ring seals and retractable engaging nut, to its multi-keyed mating interface, the SeaKing underwater connector represents a far more reliable approach to subsea power and signal connectivity. The series is available in stainless steel, titanium, and PEEK composite plastic shell materials designed for galvanic compatibility in mixed material applications, and superior corrosion resistance durability and immunity from cathodic delamination. The SeaKing PEEK series shares all the same insert arrangements, wire support, cabling, and PBOF capabilities as metal versions.



Discrete connectors,
overmolded cables,
and PBOF assemblies
available

- **Superior corrosion resistance, durability, and immunity from cathodic delamination**
- **Same high-pressure performance as stainless steel**
- **Lighter weight with lower deployment costs**
- **Zero magnetic signature**
- **Galvanically compatible with all metal materials**



SERIES 700 10K PSI / 700 BAR / 7000 M

SeaKing™ PEEK Composite Thermoplastic 10K PSI Connectors



700 Series with non-metallic PEEK shells

700-201 CABLE CONNECTOR PLUG (CCP), PEEK



SeaKing PEEK - How To Order						
Sample Part Number	700	-201	-M12	-K	S	N
Product Series	700 = SeaKing™					
Shell Style	201 = non-metallic PEEK cable connector plug (CCP)					
Shell Size-Insert Arrangement	(See page 8 – 10)					
Shell Material	K = glass-reinforced PEEK					
Contact Style	S = socket					
Polarization	A, B, C, N = normal (see sales drawing for details)					

10K PSI available in smaller shell sizes. Contact factory for details.

700-206 GLASS REINFORCED EPOXY OR GLASS HERMETIC SEAL INSERT, FLANGE CONNECTOR RECEPTACLES (FCR), PEEK



SeaKing PEEK - How To Order						
Sample Part Number	700	-206	-E4	-K	P	N
Product Series	700 = SeaKing™					
Shell Style	206 = non-metallic PEEK FCR, Glass Hermetic Seal Insert (GTMS) 226 = non-metallic PEEK FCR, Glass Reinforced Epoxy Insert (GRE)					
Shell Size-Insert Arrangement	(See page 8 – 10)					
Shell Material	K = glass-reinforced PEEK					
Contact Style	P = pin					
Polarization	A, B, C, N = normal (see sales drawing for details)					

10K PSI available in smaller shell sizes. Contact factory for details.

700-207 GLASS REINFORCED EPOXY OR GLASS-TO-METAL SEAL INSERT, BULKHEAD CONNECTOR RECEPTACLE (BCR), PEEK



SeaKing PEEK - How To Order						
Sample Part Number	700	-207	-E4	-K	P	N
Product Series	700 = SeaKing™					
Shell Style	207 = non-metallic PEEK BCR, Glass Hermetic Seal Insert (GTMS) 227 = non-metallic PEEK BCR, Glass Reinforced Epoxy Insert (GRE)					
Shell Size-Insert Arrangement	(See page 8 – 10)					
Shell Material	K = glass-reinforced PEEK					
Contact Style	P = pin					
Polarization	A, B, C, N = normal (see sales drawing for details)					

10K PSI available in smaller shell sizes. Contact factory for details.



**DEEP
WATER**



SERIES 701

SeaKing™ Junior

High-density, dry-mate, harsh-environment connectors and cables for lighter-duty ROV applications such as lights and sensors

High-density Series 701 SeaKing Junior connectors are the perfect choice for harsh-environment oil & gas industry equipment. All designs are equipped with single piston seal nitrile O-rings to withstand exposure to corrosive chemicals and high-pressure environments. These 5000 PSI pressure rated (mated condition, shell size dependent) connectors feature high-density crimp-contact or solder cup inserts, and are significantly smaller than our larger form-factor heavy-duty series 700 SeaKing interconnects. Gold-plated crimp contacts accept #12–30 gage wire. SeaKing Junior connectors are backfilled with epoxy potting compound, ready for easy incorporation into overmolded cables. Crimp-contact versions for field installation and repair are also available. SeaKing Junior is specifically designed for high-pressure, mated condition applications that do not require the extra fail-safe features and cost of an open-face rated solution.

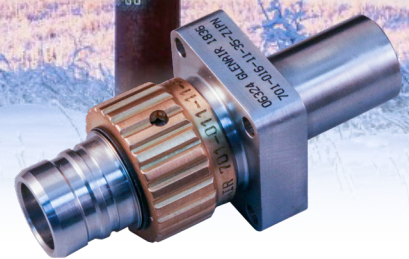

- 5000 PSI (mated condition) pressure rated connector for overmolded (non-PBOF) applications
- High density, small form-factor solution—up to 50% reduction in size and weight compared to industry standard solutions
- Ultraminiature high-density pin configurations: #22D, #20, #20HD, #16, #12, #8 signal, power, fiber optic and high-speed datalink shielded contacts

SEAKING™ JUNIOR OVERMOLDED CABLES AND PIGTAIL ASSEMBLIES

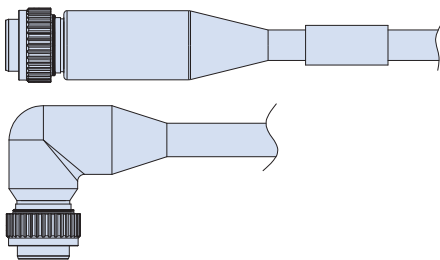

Harsh-environment polyurethane overmolded point-to-point cables with straight or right-angle ends, one-to-one wiring

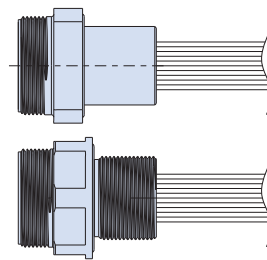

Pigtail receptacle assemblies, variable cable length, single-conductor M22759/11 wire, environmental back-end potting

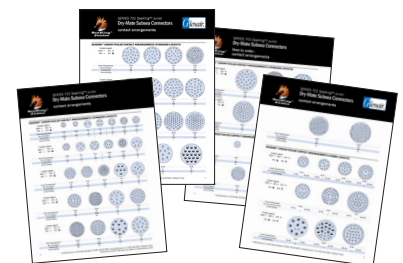

All featured insert arrangements tooled and available now including high-density and combo layouts for Coax, Twinax, and El Ochito® octaxial contacts



SERIES 701 SeaKing™ Junior High-Density Dry-Mate Connectors



5000 PSI piston-sealed connectors and cables

SERIES 701 SEAKING™ JUNIOR MECHANICAL FEATURES AND CONFIGURATIONS

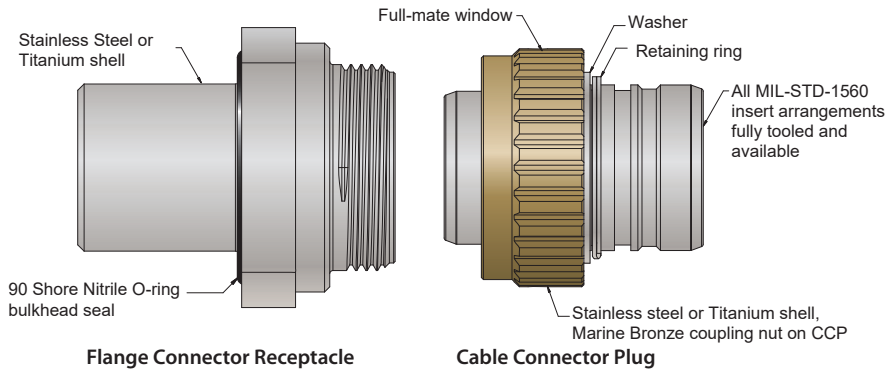

Stainless Steel or Titanium shells, Marine Bronze coupling nuts

Available in nine sizes from 2 to 128 contacts, Series 701 connectors feature stainless steel or marine bronze shells. Nitrile O-rings resist high temperature and corrosive chemicals.

5,000 PSI

These connectors withstand up to 5,000 PSI hydrostatic pressure in a mated condition.



**Series 701-011
Cable Connector
Plug (CCP)** supplied
as overmolded
cables only



**Series 701-016
Flange Connector
Receptacle (FCR)**
supplied as discrete
connectors or in
pigtail assemblies



**Series 701-017
Bulkhead Connector
Receptacle (BCR)**
supplied as discrete
connectors or in
pigtail assemblies

SEAKING™ JUNIOR CONTACT SPECIFICATIONS, MATERIALS AND FINISHES, AND CRIMP TOOLS

Service Ratings			
Service Rating	Sea Level DWV (VAC)	Operational	
		VAC	VDC
M	1300	433.3	612.8
N	1000	333.3	471.4
I	1800	600.0	484.5
II	2300	766.7	1084.2

Current Rating		
Contact Size	Amps	Wire Size
#8	46.0	8 AWG
#10	33.0	10 AWG
#12	23.0	12-14 AWG
#16	13.0	16-20 AWG
#20	7.5	20-24 AWG
#22D	5.0	22-28 AWG

Performance Specifications	
Insulation Resistance	5000 megohms at 500 VDC
Operating Temperature	-65° C to +175° C
Hydrostatic Pressure	5,000 PSI mated condition, tested per ISO 13628-6
Durability	300 mating cycles

Series 701 Polarization				
Plug	Receptacle	Key Position	Key Rotation	
			A°	B°
		Normal (N)	150°	210°
		A	75°	210°
		B	95°	230°
		C	140°	275°

Material and Finish	
Shells, Jam Nuts	Stainless steel or Titanium
CCP Coupling Nuts	Marine bronze, unplated
Contacts	Copper alloy, gold plated.
Insulators	Composite thermoplastic
Retaining ring and hardware	Stainless steel
Interfacial Seal (pin inserts only) and Grommet	Fluorosilicone
O-rings and Seals	Nitrile, 90 shore Viton®, 90 shore Viton® O-rings offer wider temperature range

Contact Crimp Tools		
Contact Size	Crimp Tool	Positioner
#12	809-136	809-137
#16	809-136	809-137
#20	809-136	809-137
#22D	809-015	K42 Pin
		K40 Skt



SERIES 701 SeaKing™ Junior High-Density Dry-Mate Connectors



Overmolded cables and pigtail assemblies

SEAKING™ JUNIOR POINT-TO-POINT PLUG-TO-PLUG OVERMOLDED CABLE

SeaKing Junior - How To Order CCP Cable Assemblies							
Sample Part Number	7071-0067	9-35	Z1	S	N	36	
Series	7071-0067 = SeaKing Junior Cable Assembly						
Insert Arrangement	See insert arrangement tables pages 23–28						
Material / Finish	Z1 = Stainless Steel Body and Marine Bronze Coupling Nut TC = Titanium						
Contact Style	S = Socket						
Polarization	N = Normal, A, B, C (see Polarization Table, page 22)						
Cable Length	Length = in inches; ie 36 = 36 inches						

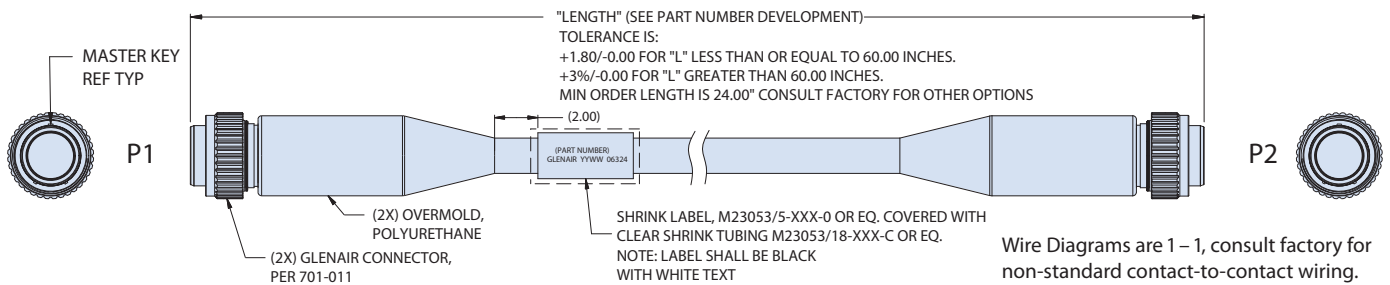

SEAKING™ JUNIOR SINGLE-ENDED RECEPTACLE ASSEMBLY

SeaKing Junior - How To Order FCR and BCR Receptacle Assemblies							
Sample Part Number	7071-0068	1	9-35	Z1	P	N	36
Series	7071-0068 = SeaKing Junior Cable Assembly						
Receptacle Style	1 = Flange Connector Receptacle (701-016) 2 = Bulkhead Connector Receptacle (701-017)						
Insert Arrangement	See insert arrangement tables pages 23–28						
Material / Finish	Z1 = Stainless Steel Body and Marine Bronze Coupling Nut TC = Titanium						
Contact Style	P = Pin						
Polarization	N = Normal, A, B, C (see Polarization Table, page 22)						
Cable Length	Length = in inches; ie 36 = 36 inches						

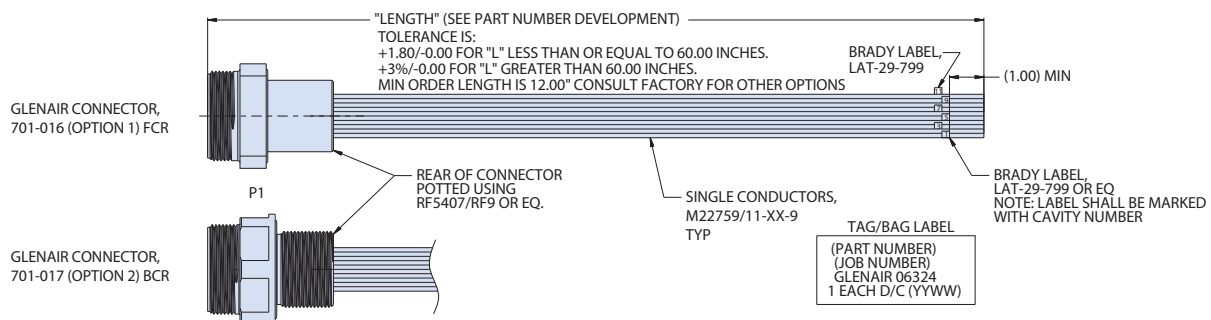



SERIES 701 SeaKing™ Junior Dry-Mate Subsea Connectors



701-011 Plug, High Density with crimp removable contacts

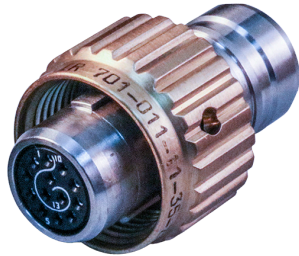

HOW TO ORDER					
Sample Part Number	701-011	-13-08	-Z1	S	N
Product Series	701-011 = SeaKing Junior				
Shell Size-Contact Arrangement	See Contact Arrangements table				
Barrel Material	Z1 = 316 Stainless Steel* (Marine Bronze Coupling Nut) TC = Titanium XO = PEEK**				
Contact Style	A = Pin Insert (No Contacts Included) B = Socket Insert (No Contacts Included) P = Pin S = Socket				
Key Position	A, B, C, D, E (See table)				

* 316 Stainless steel for sizes 09 through 19 2507 Super duplex for sizes 21 through 25
** Consult factory for pressure rating

NOTES

Pressure rating: Mated condition - 5,000 PSI

Materials tested to:

- Salt spray, per MIL-STD-202 method 101
- Humidity, per MIL-STD-202 method 101
- Thermal cycle, per EIA-455-71

Single O-ring sealing.

MATERIAL/FINISH

Plug barrel: See part number development

Coupling nut: Marine bronze for Z1 connectors
Titanium for TC connectors

Contacts: Copper alloy, gold plated

Insulator: High grade rigid dielectric

Retaining ring: 316 stainless steel

Interfacial seal (pin inserts only):

Fluorosilicone

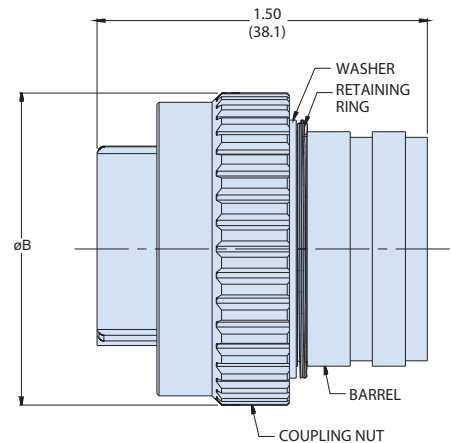
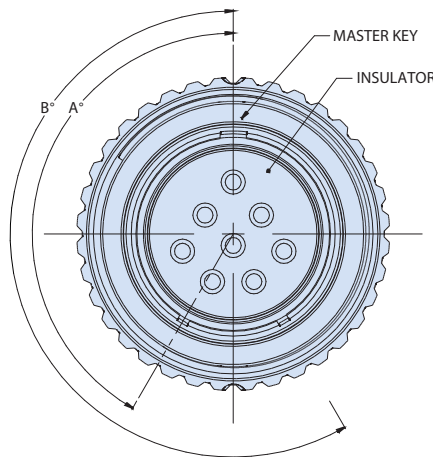

DIMENSIONS			
Shell Size	Thread A	Ø B Max	
		In.	mm
09	0.7500-20 UNEF-2B	0.935	23.7
11	0.8750-20 UNEF-2B	1.060	26.9
13	1.0000-20 UNEF-2B	1.185	30.1
15	1.1250-20 UN-2B	1.310	33.3
17	1.2500-20 UN-2B	1.435	36.4
19	1.3750-20 UN-2B	1.560	39.6
21	1.5000-20 UN-2B	1.685	42.8
23	1.6250-20 UN-2B	1.810	46.0
25	1.7500-20 UN-2B	1.935	49.1

ALTERNATE KEY POSITIONS		
Position	A°	B°
N	150°	210°
A	75°	210°
B	95°	230°
C	140°	275°
D	75°	275°
E	95°	210°



SERIES 701 SeaKing™ Junior Dry-Mate Subsea Connectors



701-017 Bulkhead Connector Receptacle, high density with crimp removable contacts



HOW TO ORDER					
Sample Part Number	701-017	-17-08	-Z1	P	N
Product Series	701-017 = SeaKing Junior				
Shell Size-Contact Arrangement	See Contact Arrangements table				
Barrel Material	Z1 = 316 Stainless Steel* TC = Titanium XO = PEEK**				
Contact Style	A = Pin Insert (No Contacts Included) B = Socket Insert (No Contacts Included) P = Pin S = Socket				
Key Position	A, B, C, D, E (See table)				

* 316 Stainless steel for sizes 09 through 15 2507 Super duplex for sizes 11 through 25
** Consult factory for pressure rating

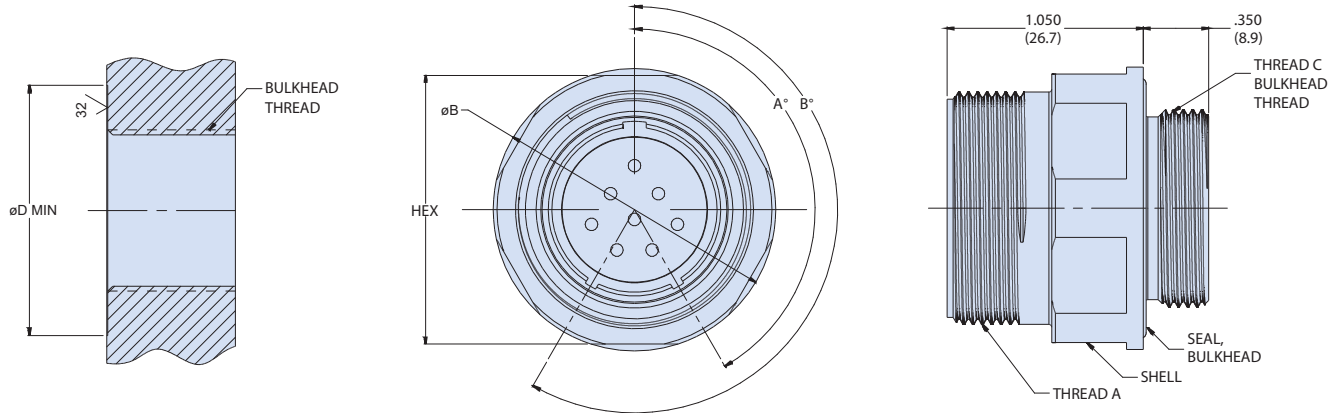

DIMENSIONS										
Shell Size	Thread A	B MAX		Hex		Thread C	D Min		Bulkhead Seal	Bore Seal
		inch	mm	inch	mm		inch	mm		
09	0.7500-20 UNEF-2A	1.025	26.0	15/16	23.8	0.5625-20 UN-2A	1.030	26.2	2-018	2-014
11	0.8750-20 UNEF-2A	1.150	29.2	1 1/16	27.0	0.6875-20 UN-2A	1.160	29.5	2-020	2-016
13	1.0000-20 UNEF-2A	1.275	32.4	1 3/16	30.2	0.8125-20 UNEF-2A	1.310	33.3	2-022	2-018
15	1.1250-20 UN-2A	1.410	35.8	1 5/16	33.3	0.9375-20 UNEF-2A	1.430	36.3	2-024	2-020
17	1.2500-20 UN-2A	1.525	38.7	1 7/16	36.5	1.0625-20 UN-2A	1.560	39.6	2-026	2-022
19	1.3750-20 UN-2A	1.650	41.9	1 9/16	39.7	1.1875-20 UN-2A	1.680	42.7	2-028	2-024
21	1.5000-20 UN-2A	1.775	45.1	1 11/16	42.9	1.3125-20 UN-2A	1.810	46.0	2-029	2-026
23	1.6250-20 UN-2A	1.900	48.3	1 13/16	46.0	1.4375-20 UN-2A	1.950	49.5	2-030	2-028
25	1.7500-20 UN-2A	2.025	51.4	1 15/16	49.2	1.5625-20 UN-2A	2.070	52.6	2-031	2-029

NOTES

Pressure rating: Mated condition - 5,000 PSI
Materials tested to:
- Salt spray, per MIL-STD-202 method 101
- Humidity, per MIL-STD-202 method 101
- Thermal cycle, per EIA-455-71
Single O-ring sealing.

MATERIAL/FINISH

Receptacle shell: See part number development
Contacts: Copper alloy, gold plated
Insulator: High grade rigid dielectric
Interfacial seal (pin inserts only) & grommet: Fluorosilicone
Seals: Nitrile

ALTERNATE KEY POSITIONS

Position	A°	B°
N	150°	210°
A	75°	210°
B	95°	230°
C	140°	275°
D	75°	275°
E	95°	210°



SERIES 701 SeaKing™ Junior Dry-Mate Subsea Connectors



701-016 Flange Connector Receptacle, high density with crimp removable contacts

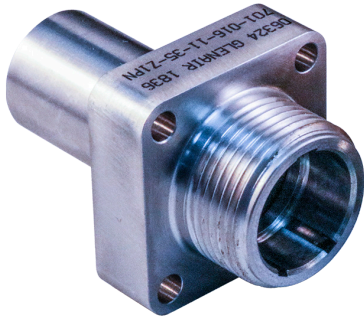

HOW TO ORDER					
Sample Part Number	701-016	-17-08	-Z1	P	N
Product Series	701-016 = SeaKing Junior				
Shell Size-Contact Arrangement	See Contact Arrangements table				
Barrel Material	Z1 = 316 Stainless Steel* TC = Titanium XO = PEEK**				
Contact Style	A = Pin Insert (No Contacts Included) B = Socket Insert (No Contacts Included) P = Pin S = Socket				
Key Position	A, B, C, D, E (See table)				

* 316 Stainless steel for sizes 09 2507 Super duplex for sizes 11 through 25
** Consult factory for pressure rating

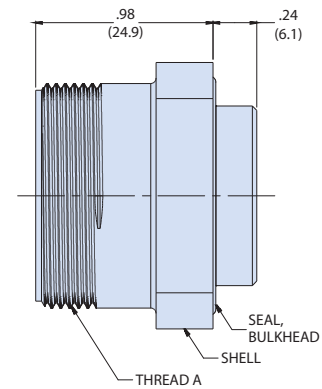
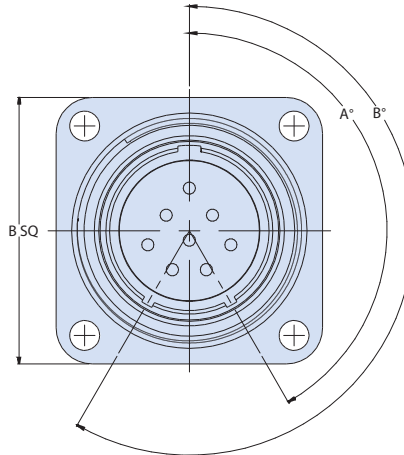
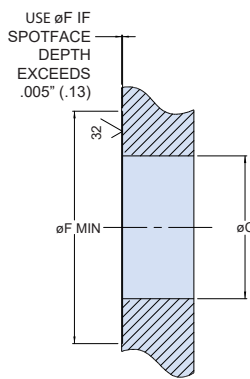

DIMENSIONS														
Shell Size	Thread A	B MAX		C*		D*		E* Flange Screw Size	F Min, .005		F' Min, >.005		Bulkhead Seal	Bore Seal
		inch	mm	inch	mm	inch	mm		inch	mm	inch	mm		
09	0.7500-20 UNEF-2A	1.085	27.6	0.530	13.5	0.770	19.6	#4-40	0.885	22.5	1.460	37.1	2-017	2-014
11	0.8750-20 UNEF-2A	1.175	29.8	0.655	16.6	0.860	21.8	#4-40	1.015	25.8	1.600	40.6	2-019	2-016
13	1.0000-20 UNEF-2A	1.265	32.1	0.760	19.3	0.950	24.1	#4-40	1.120	28.4	1.690	42.9	2-021	2-018
15	1.1250-20 UN-2A	1.405	35.7	0.895	22.7	1.070	27.2	#6-32	1.250	31.8	1.955	49.7	2-023	2-020
17	1.2500-20 UN-2A	1.495	38.0	1.020	25.9	1.160	29.5	#6-32	1.375	34.9	2.065	52.5	2-025	2-022
19	1.3750-20 UN-2A	1.710	43.4	1.125	28.6	1.250	31.8	#8-32	1.480	37.6	2.320	58.9	2-026	2-024
21	1.5000-20 UN-2A	1.850	47.0	1.250	31.8	1.390	35.3	#8-32	1.610	40.9	2.485	63.1	2-028	2-026
23	1.6250-20 UN-2A	1.940	49.3	1.350	34.3	1.480	37.6	#8-32	1.705	43.3	2.520	64.0	2-029	2-028
25	1.7500-20 UN-2A	2.030	54.6	1.500	38.1	1.570	39.9	#8-32	1.855	47.1	2.745	69.7	2-030	2-029

*For dimension see next page.

NOTES

Pressure rating: Mated condition - 5,000 PSI
Materials tested to:
- Salt spray, per MIL-STD-202 method 101
- Humidity, per MIL-STD-202 method 101
- Thermal cycle, per EIA-455-71
Single O-ring sealing.

MATERIAL/FINISH

Receptacle shell: See part number development
Contacts: Copper alloy, gold plated
Insulator: High grade rigid dielectric
Interfacial seal (pin inserts only) & grommet:
Fluorosilicone
Seals: Nitrile



SERIES 701 SeaKing™ Junior Dry-Mate Subsea Connectors



701-016 Flange Connector Receptacle,
high density with crimp removable contacts

ALTERNATE KEY POSITIONS		
Position	A°	B°
N	150°	210°
A	75°	210°
B	95°	230°
C	140°	275°
D	75°	275°
E	95°	210°

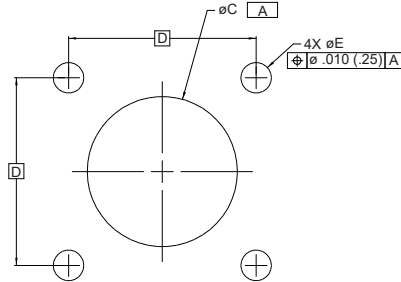



SERIES 701 SeaKing™ Junior High-Density PEEK Subsea Connectors



701-038 PEEK Cable Connector Plug with crimp-removable contacts

HOW TO ORDER					
Sample Part Number	701-038	-17-08	-K	S	N
Product Series	701-038 = SeaKing Junior				
Shell Size-Contact Arrangement	See Contact Arrangements table				
Barrel Material	K = 30% Reinforced PEEK				
Contact Style	A = Pin Insert (No Contacts Included) B = Socket Insert (No Contacts Included) P = Pin S = Socket				
Key Position	A, B, C, D, E (See table)				

NOTES

Pressure rating: Mated condition - 5,000 PSI, tested per ISO 13628-6.
Materials tested to:
- Salt spray, per MIL-STD-202 method 101
- Humidity, per MIL-STD-202 method 101
- Thermal cycle, per EIA-455-71
Single O-ring sealing.

MATERIAL/FINISH

Plug barrel: 30% reinforced PEEK
Coupling nut: 30% reinforced PEEK
Contacts: Copper alloy, gold plated
Insulator: High grade rigid dielectric
Retaining ring: 316 stainless steel
Interfacial seal (pin inserts only): Fluorosilicone

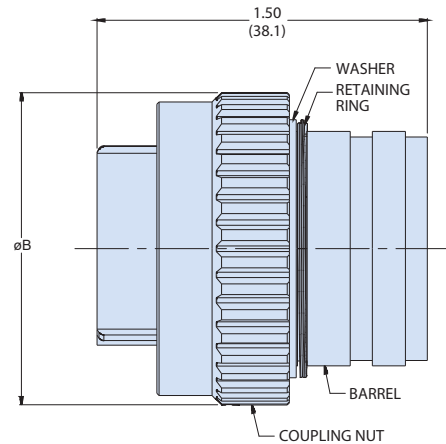
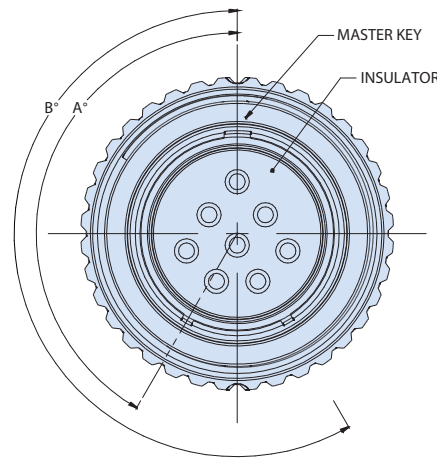

Shell Size	Thread A	DIMENSIONS	
		Ø B	
		In.	mm
09	0.7500-20 UNEF-2B	0.935	23.7
11	0.8750-20 UNEF-2B	1.060	26.9
13	1.0000-20 UNEF-2B	1.185	30.1
15	1.1250-20 UN-2B	1.310	33.3
17	1.2500-20 UN-2B	1.435	36.4
19	1.3750-20 UN-2B	1.560	39.6
21	1.5000-20 UN-2B	1.685	42.8
23	1.6250-20 UN-2B	1.810	46.0
25	1.7500-20 UN-2B	1.935	49.1

Position	ALTERNATE KEY POSITIONS	
	A°	B°
N	150°	210°
A	75°	210°
B	95°	230°
C	140°	275°
D	75°	275°
E	95°	210°



SERIES 701 SeaKing™ Junior High-Density PEEK Subsea Connectors



701-040 PEEK Bulkhead Connector Receptacle with crimp removable contacts

SeaKing Plug - How To Order						
Sample Part Number	701-040	-17-08	K	P	1	N
Product Series	701-040 = SeaKing Junior					
Shell Size-Contact Arrangement	See Contact Arrangements table					
Barrel Material	K = 30% Reinforced PEEK					
Contact Style	A = Pin Insert (No Contacts Included) B = Socket Insert (No Contacts Included) P = Pin S = Socket					
O-Ring Material	1 = 90 Shore Nitrile 2 = 90 Shore Vitron					
Key Position	A, B, C, D, E (See table)					

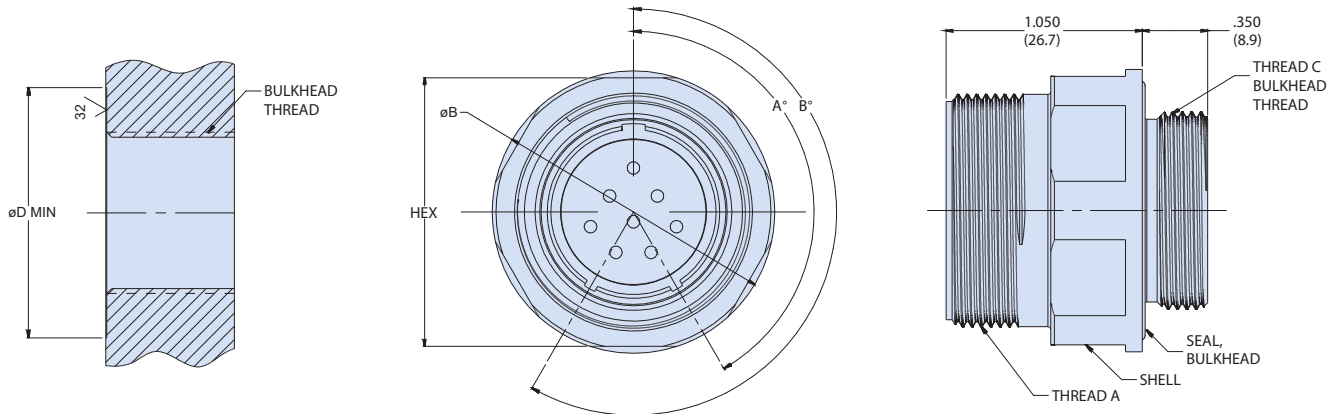

DIMENSIONS										
Shell Size	Thread A	B MAX		Hex		Thread C	D Min		Bulkhead Seal	Bore Seal
		inch	mm	inch	mm		inch	mm		
09	0.7500-20 UNEF-2A	1.025	26.0	15/16	23.8	0.5625-20 UN-2A	1.030	26.2	2-018	2-014
11	0.8750-20 UNEF-2A	1.150	29.2	1 1/16	27.0	0.6875-20 UN-2A	1.160	29.5	2-020	2-016
13	1.0000-20 UNEF-2A	1.275	32.4	1 3/16	30.2	0.8125-20 UNEF-2A	1.310	33.3	2-022	2-018
15	1.1250-20 UN-2A	1.410	35.8	1 5/16	33.3	0.9375-20 UNEF-2A	1.430	36.3	2-024	2-020
17	1.2500-20 UN-2A	1.525	38.7	1 7/16	36.5	1.0625-20 UN-2A	1.560	39.6	2-026	2-022
19	1.3750-20 UN-2A	1.650	41.9	1 9/16	39.7	1.1875-20 UN-2A	1.680	42.7	2-028	2-024
21	1.5000-20 UN-2A	1.775	45.1	1 11/16	42.9	1.3125-20 UN-2A	1.810	46.0	2-029	2-026
23	1.6250-20 UN-2A	1.900	48.3	1 13/16	46.0	1.4375-20 UN-2A	1.950	49.5	2-030	2-028
25	1.7500-20 UN-2A	2.025	51.4	1 15/16	49.2	1.5625-20 UN-2A	2.070	52.6	2-031	2-029

NOTES

Pressure rating: mated condition - 5,000 PSI, tested per ISO 13628-6.

Materials tested to:

- Salt spray, per MIL-STD-202 method 101
- Humidity, per MIL-STD-202 method 101
- Thermal cycle, per EIA-455-71

Single O-ring sealing.

MATERIAL/FINISH

Receptacle shell: 30% reinforced PEEK

Contacts: Copper alloy, gold plated

Insulator: High grade rigid dielectric

Interfacial seal (pin inserts only) & grommet: Fluorosilicone

ALTERNATE KEY POSITIONS

Position	A°	B°
N	150°	210°
A	75°	210°
B	95°	230°
C	140°	275°
D	75°	275°
E	95°	210°



SERIES 701 SeaKing™ Junior High-Density PEEK Subsea Connectors



701-039 PEEK Flange Connector Receptacle with crimp removable contacts

HOW TO ORDER	
Sample Part Number	701-039 -17-08 -K P 1 N
Product Series	701-039 = SeaKing Junior
Shell Size-Contact Arrangement	See Contact Arrangements table
Barrel Material	K = 30% Reinforced PEEK
Contact Style	A = Pin Insert (No Contacts Included) B = Socket Insert (No Contacts Included) P = Pin S = Socket
O-Ring Material	1 = 90 Shore Nitrile 2 = 90 Shore Vitron
Key Position	A, B, C, D, E (See table)

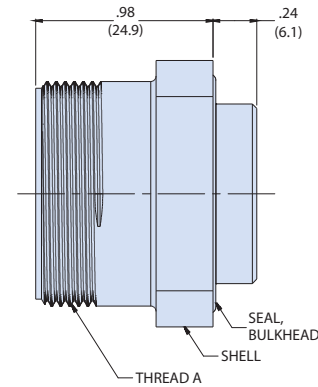
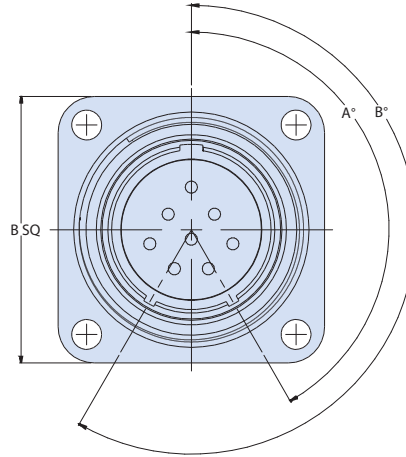
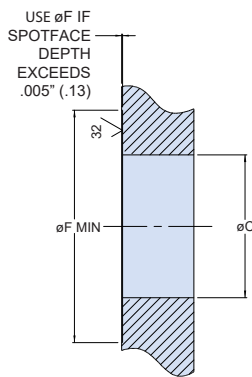

DIMENSIONS														
Shell Size	Thread A	B MAX		C*		D*		E* Flange Screw Size	F Min, .005		F Min, >.005		Bulkhead Seal	Bore Seal
		inch	mm	inch	mm	inch	mm		inch	mm	inch	mm		
09	0.7500-20 UNEF-2A	1.085	27.6	0.530	13.5	0.770	19.6	#4-40	0.885	22.5	1.460	37.1	2-017	2-014
11	0.8750-20 UNEF-2A	1.175	29.8	0.655	16.6	0.860	21.8	#4-40	1.015	25.8	1.600	40.6	2-019	2-016
13	1.0000-20 UNEF-2A	1.265	32.1	0.760	19.3	0.950	24.1	#4-40	1.120	28.4	1.690	42.9	2-021	2-018
15	1.1250-20 UN-2A	1.405	35.7	0.895	22.7	1.070	27.2	#6-32	1.250	31.8	1.955	49.7	2-023	2-020
17	1.2500-20 UN-2A	1.495	38.0	1.020	25.9	1.160	29.5	#6-32	1.375	34.9	2.065	52.5	2-025	2-022
19	1.3750-20 UN-2A	1.710	43.4	1.125	28.6	1.250	31.8	#8-32	1.480	37.6	2.320	58.9	2-026	2-024
21	1.5000-20 UN-2A	1.850	47.0	1.250	31.8	1.390	35.3	#8-32	1.610	40.9	2.485	63.1	2-028	2-026
23	1.6250-20 UN-2A	1.940	49.3	1.350	34.3	1.480	37.6	#8-32	1.705	43.3	2.520	64.0	2-029	2-028
25	1.7500-20 UN-2A	2.030	54.6	1.500	38.1	1.570	39.9	#8-32	1.855	47.1	2.745	69.7	2-030	2-029

*For dimension see next page.

NOTES

Pressure rating: Mated condition - 5,000 PSI, tested per ISO 13628-6.

Materials tested to:

- Salt spray, per MIL-STD-202 method 101
- Humidity, per MIL-STD-202 method 101
- Thermal cycle, per EIA-455-71

Single O-ring sealing.

MATERIAL/FINISH

Receptacle shell: 30% reinforced PEEK

Contacts: Copper alloy, gold plated

Insulator: High grade rigid dielectric

Interfacial seal (pin inserts only) & grommet: Fluorosilicone



SERIES 701 SeaKing™ Junior
High-Density PEEK Subsea Connectors



**701-039 PEEK Flange Connector Receptacle
 with crimp removable contacts**

ALTERNATE KEY POSITIONS		
Position	A°	B°
N	150°	210°
A	75°	210°
B	95°	230°
C	140°	275°
D	75°	275°
E	95°	210°

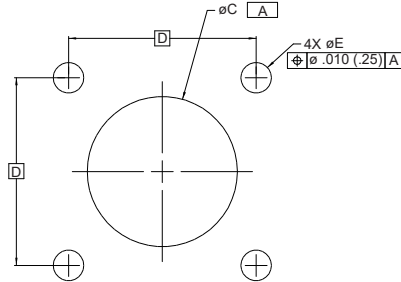



SERIES 701 SeaKing™ Junior High-Density Dry-Mate Connectors Insert arrangements



SEAKING™ JUNIOR TOOLED INSERT ARRANGEMENTS (STANDARD LAYOUTS)

Contact Legend

#22D • #16 ⊕
#20 ⊖ #12 ◐

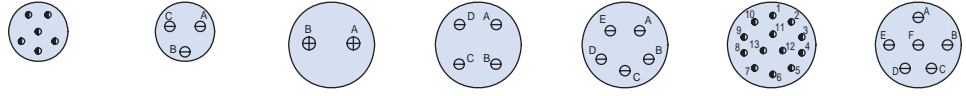

Insert Arrangement	9-35	9-98	11-2	11-4	11-5	11-35	11-98
No. of Contacts	6	3	2	4	5	13	6
Contact Size	#22D	#20	#16	#20	#20	#22D	#20
Service Rating	M	I	I	I	I	M	I

Contact Legend

#22D • #16 ⊕
#20 ⊖ #12 ◐

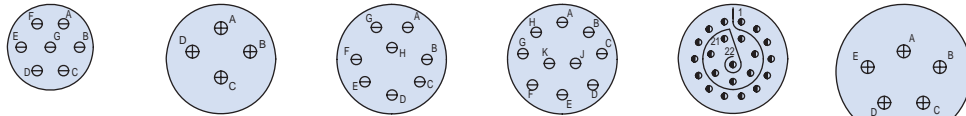

Insert Arrangement	11-99	13-4	13-8	13-98	13-35	15-5
No. of Contacts	7	4	8	10	22	5
Contact Size	#20	#16	#20	#20	#22D	#16
Service Rating	I	I	I	I	M	II

Contact Legend

#22D • #16 ⊕
#20 ⊖ #12 ◐

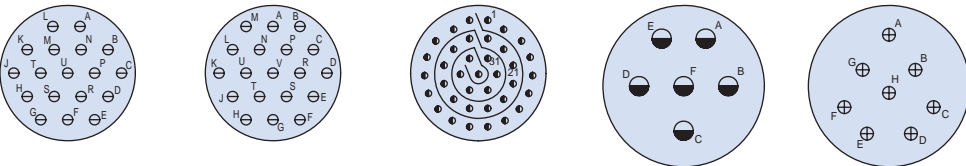

Insert Arrangement	15-18	15-19	15-35	17-6	17-8
No. of Contacts	18	19	37	6	8
Contact Size	#20	#20	#22D	#12	#16
Service Rating	I	I	M	I	II

Contact Legend

#22D • #16 ⊕
#20 ⊖ #12 ◐

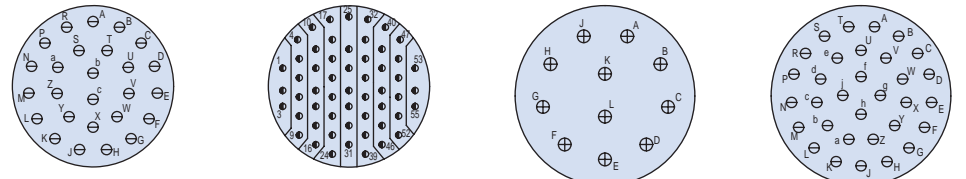

Insert Arrangement	17-26	17-35	19-11	19-32
No. of Contacts	26	55	11	32
Contact Size	#20	#22D	#16	#20
Service Rating	I	M	II	I

Contact Legend

#22D • #16 ⊕
#20 ⊖ #12 ◐

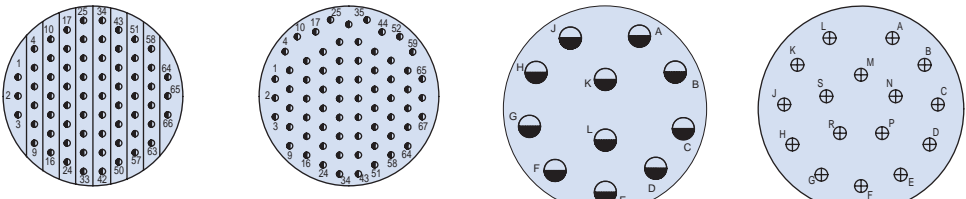

Insert Arrangement	19-35	19-45	21-11	21-16
No. of Contacts	66	67	11	16
Contact Size	#22D	#22D	#12	#16
Service Rating	M	M	I	II



SERIES 701 SeaKing™ Junior High-Density Dry-Mate Connectors Insert arrangements



SEAKING™ JUNIOR TOOLED INSERT ARRANGEMENTS (STANDARD LAYOUTS)

Contact Legend

#22D • #16 ⊕
#20 ⊖ #12 ●

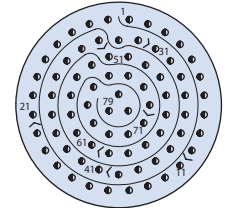
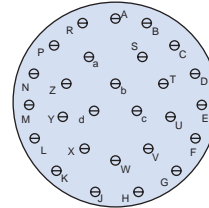
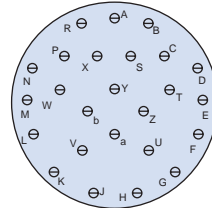
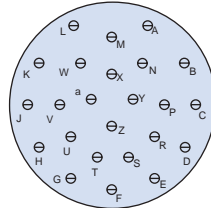

Insert Arrangement	21-24	21-25	21-27	21-35
No. of Contacts	24	25	27	79
Contact Size	#20	#20	#20	#22D
Service Rating	I	I	I	M

Contact Legend

#22D • #16 ⊕
#20 ⊖ #12 ●

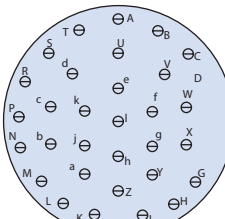
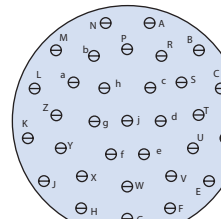
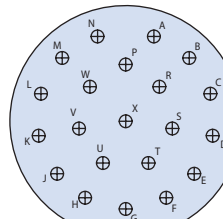
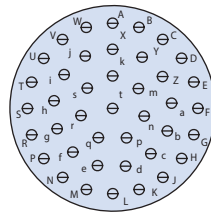

Insert Arrangement	21-41	23-21	23-32	23-34
No. of Contacts	41	21	32	34
Contact Size	#20	#16	#20	#20
Service Rating	I	II	I	I

Contact Legend

#22D • #16 ⊕
#20 ⊖ #12 ●

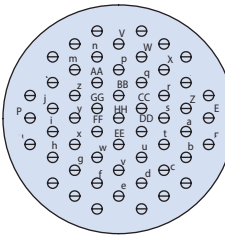
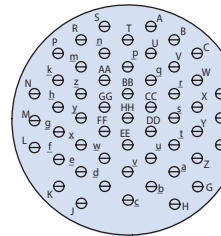
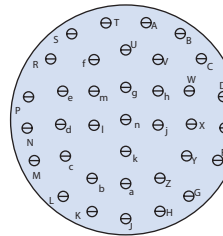
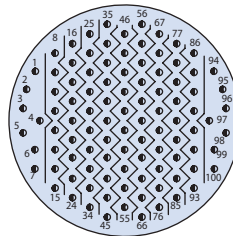

Insert Arrangement	23-35	23-36	23-53	23-55
No. of Contacts	100	36	53	55
Contact Size	#22D	#20	#20	#20
Service Rating	M	I	I	I

Contact Legend

#22D • #16 ⊕
#20 ⊖ #12 ●

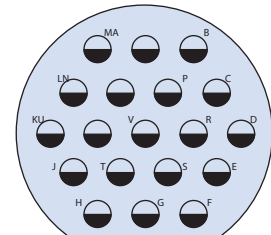
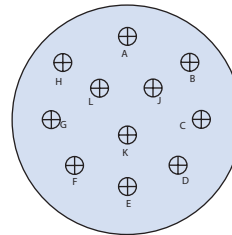
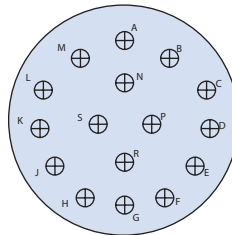

Insert Arrangement	23-97	23-99	25-19
No. of Contacts	16	11	19
Contact Size	#16	#16	#12
Service Rating	I	II	I



SERIES 701 SeaKing™ Junior High-Density Dry-Mate Connectors Insert arrangements



SEAKING™ JUNIOR TOOLED INSERT ARRANGEMENTS (STANDARD LAYOUTS)

Contact Legend
 #22D • #16 ⊕
 #20 ⊖ #12 ⊖

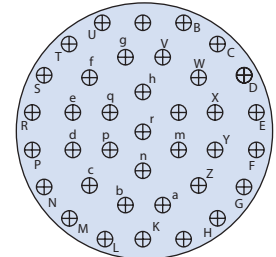
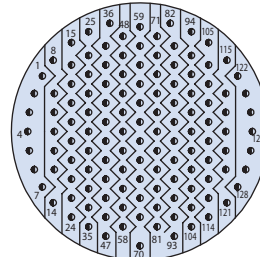
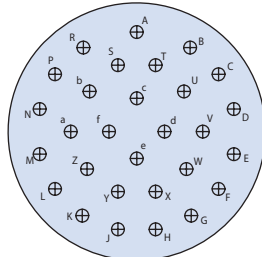

Insert Arrangement	25-29	25-35	25-37
No. of Contacts	29	128	37
Contact Size	#16	#22D	#16
Service Rating	I	M	II

Contact Legend
 #22D • #16 ⊕
 #20 ⊖ #12 ⊖

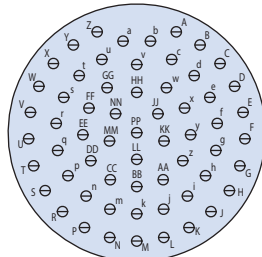

Insert Arrangement	25-61
No. of Contacts	61
Contact Size	#20
Service Rating	I

SEAKING™ JUNIOR TOOLED INSERT ARRANGEMENTS (HIGH-DENSITY LAYOUTS)

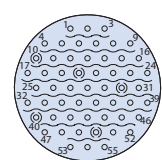
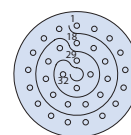
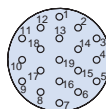

Insert Arrangement	9-23	11-23	13-23	15-23
No. of Contacts	9	19	32	55
Contact Size	#23	#23	#23	#23
Service Rating	N	N	N	N

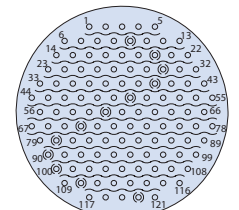
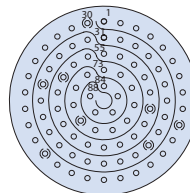
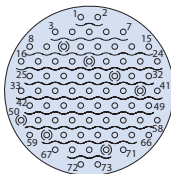

Insert Arrangement	17-23	19-23	21-23
No. of Contacts	73	88	121
Contact Size	#23	#23	#23
Service Rating	N	N	N



SERIES 701 SeaKing™ Junior High-Density Dry-Mate Connectors Insert arrangements



SEAKING™ JUNIOR TOOLED INSERT ARRANGEMENTS (HIGH-DENSITY LAYOUTS)

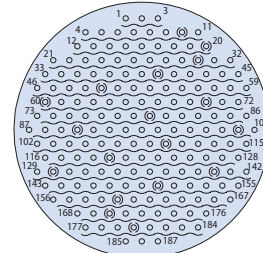
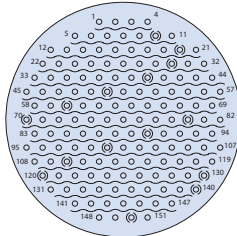

Insert Arrangement	23-23	25-23
No. of Contacts	151	187
Contact Size	#23	#23
Service Rating	N	N

SEAKING™ JUNIOR TOOLED INSERT ARRANGEMENTS (COMBO LAYOUTS)

Contact Legend
 #22D • #20 ⊖ #16 ⊕
 #12 ◐ #10 ⊙

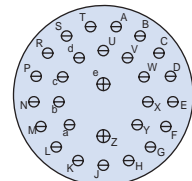
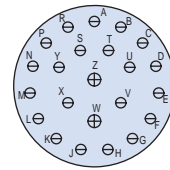
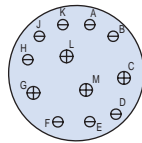
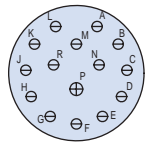

Insert Arrangement	15-15		15-97		17-99		19-28	
No. of Contacts and Size	1X #16	14X #20	4X #16	8X #20	2X #16	21X #20	2X #16	26X #20
Service Rating								

Contact Legend
 #22D • #20 ⊖ #16 ⊕
 #12 ◐ #10 ⊙

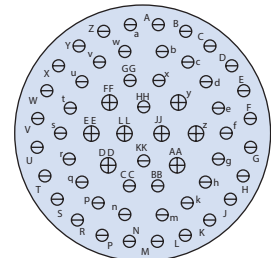
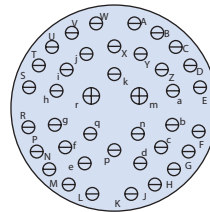
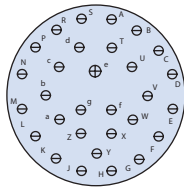

Insert Arrangement	19-30		21-39		25-48	
No. of Contacts and Size	1X #16	29X #20	2X #16	37X #20	8X #16	48X #20
Service Rating						

Contact Legend
 #22D • #20 ⊖ #16 ⊕
 #12 ◐ #10 ⊙

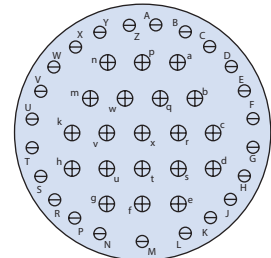
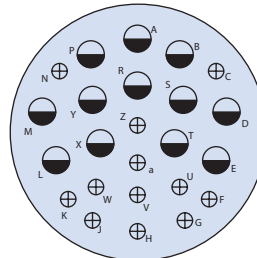
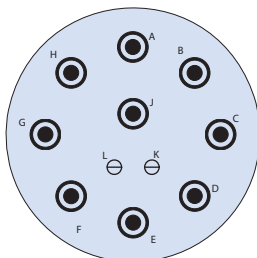

Insert Arrangement	25-11		25-24		25-43	
No. of Contacts and Size	9X #10	2X #20	12X #12	12X #16	20X #16	23X #20
Service Rating	N					



SERIES 701 SeaKing™ Junior High-Density Dry-Mate Connectors Insert arrangements



SEAKING™ JUNIOR TOOLED INSERT ARRANGEMENTS (SPECIAL SHIELDED LAYOUTS)

Contact Legend

- #22D
- #20
- #8
- #16
- #12

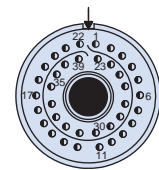
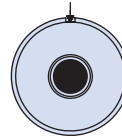
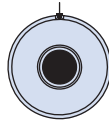

Shell Size - Insert Arrangement	9-1	11-1*	17-2
No. of Contacts	1x #8	1x #8	1x #8 38x #22D

Contact Legend

- #22D
- #20
- #8
- #16
- #12

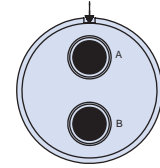
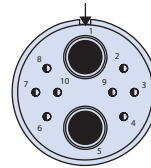
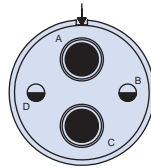

Shell Size - Insert Arrangement	17-22	17-60	17-75
No. of Contacts	2x #8 2x #12	2x #8 8x #22	2x #8

Contact Legend

- #22D
- #20
- #8
- #16
- #12

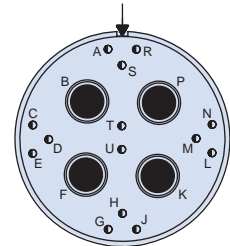
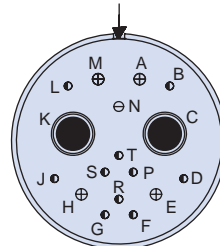
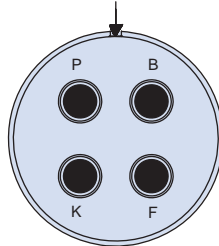

Shell Size - Insert Arrangement	19-4	19-17	19-18
No. of Contacts	4x #8	2x #8 4x #16 1x #20 10x #22D	4x #8 14x #22D

Contact Legend

- #22D
- #20
- #8
- #16
- #12

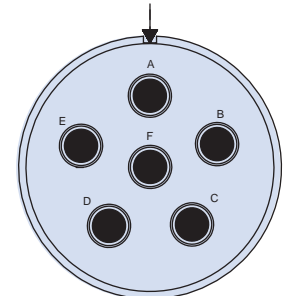
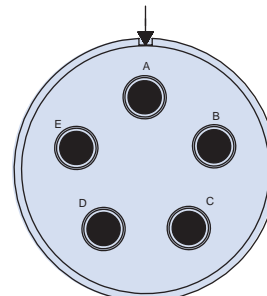
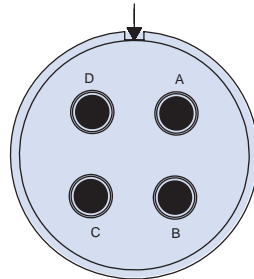

Shell Size - Insert Arrangement	21-75	23-5	23-6
No. of Contacts and Size	4x #8	5x #8	6x #8



SERIES 701 SeaKing™ Junior High-Density Dry-Mate Connectors Insert arrangements



SEAKING™ JUNIOR TOOLED INSERT ARRANGEMENTS (SPECIAL SHIELDED LAYOUTS)

Contact Legend

- #22D
- #20
- #8
- #16
- #12

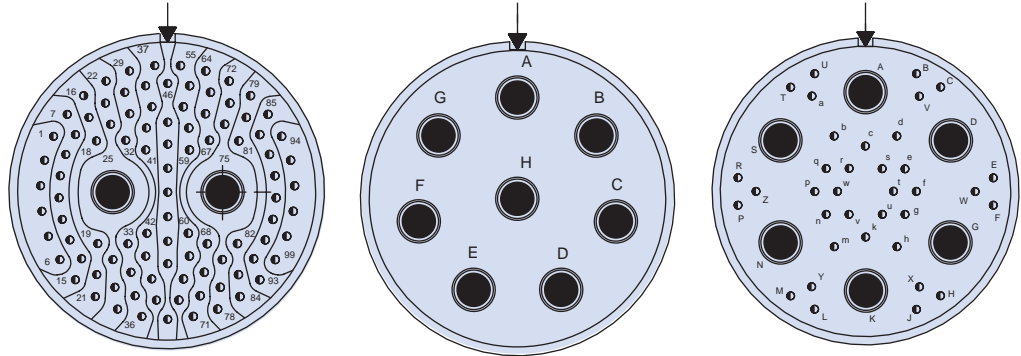

Shell Size - Insert Arrangement	25-7		25-8		25-17	
No. of Contacts and Size	2x #8	97x #22	8x #8		6x #8	36x #22

Contact Legend

- #22D
- #20
- #8
- #16
- #12

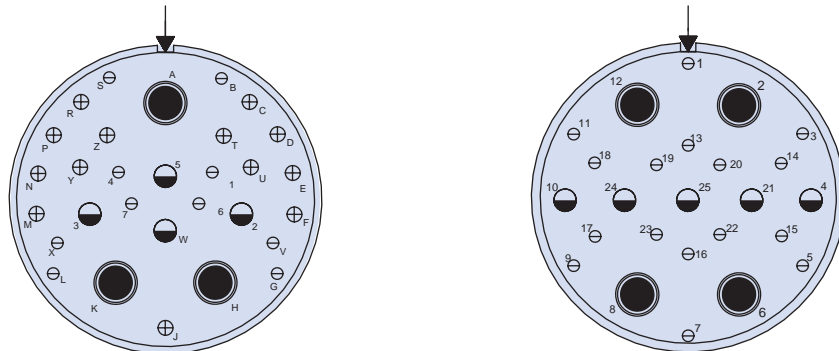

Shell Size - Insert Arrangement	25-20				25-26		
No. of Contacts and Size	3x #8	4x #12	13x #16	10x #20	4x #8	5x #12	16x #20

Contact Legend

- #22D
- #20
- #8
- #16
- #12

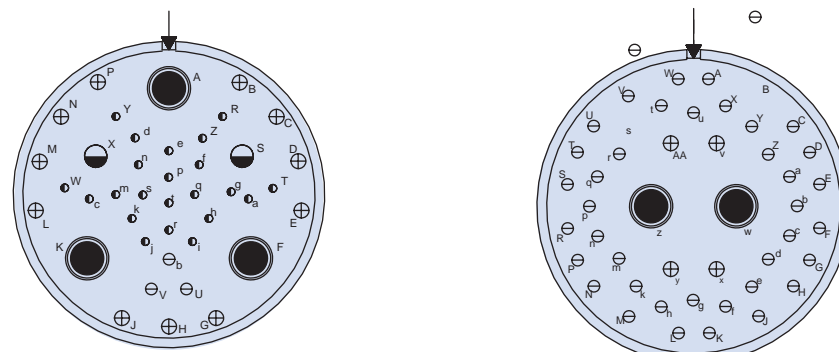

Shell Size - Insert Arrangement	25-41					25-46		
No. of Contacts and Size	3x #8	2x #12	11x #16	3x #20	22x #22D	2x #8	4x #16	40x #20



**DEEP
WATER**

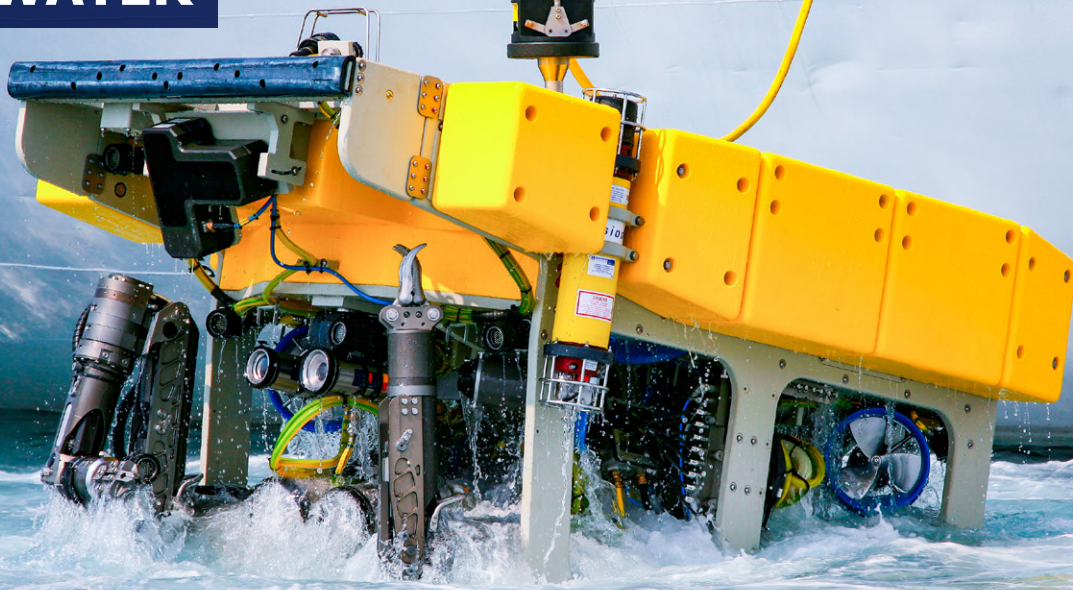

DEEP WATER

SeaKing™ Fiber Optic

10K PSI open-face pressure rated fiber optic connectors, cables and jumpers—singlemode and multimode with low dB data loss



Data-intensive applications such as towed array sonar systems, well logging and monitoring equipment, digital seismic streamers, as well as magnetic flux leakage and ultrasonic inspection sensors used in intelligent pipeline inspection are ideally suited for ruggedized high-pressure fiber optics. Fiber optic interconnect systems deliver ultra high data bandwidth, immunity from RFI and other forms of electromagnetic interference, as well as reduced size and weight compared to high-speed copper. Glenair SeaKing™ Fiber Optic solutions include harsh-environment overmolded cable assemblies, multibranch inside-the-box jumpers, as well as Glenair signature high-temp, high-vibration transceivers and optical-to-electrical media converters. Pressure-balanced oil-filled (PBOF) cable assemblies are also available for deep subsea applications.



- **Overmolded and PBOF butt-joint assemblies**
- **Full hydrostatic qualification test report available**
- **Wide range of fiber and hybrid fiber/electric layouts**
- **Singlemode and multimode**
- **<1.0db data loss for singlemode**



DEEP WATER SeaKing™ Fiber Optic



10K PSI open-face pressure-rated fiber optic connectors and cables

ENVIRONMENTAL OVERMOLDED FIBER OPTIC JUMPERS

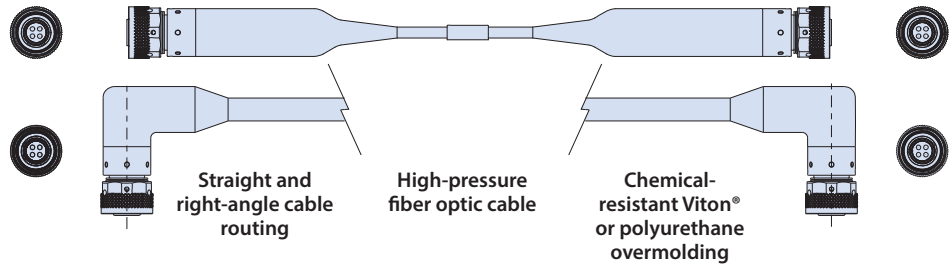
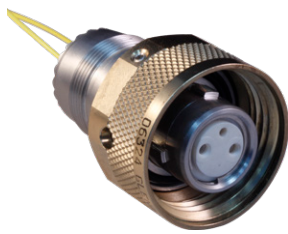

PRESSURE-BALANCED OIL-FILLED (PBOF) HIGH-PRESSURE FIBER OPTIC ASSEMBLIES

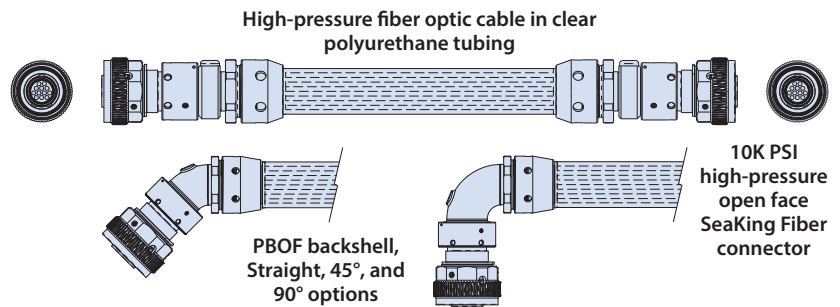

SEAKING™ BCR OR FCR TO COMMERCIAL FIBER OPTIC PIGTAIL ASSEMBLY FOR I/O-TO-BOARD MODULE APPLICATIONS

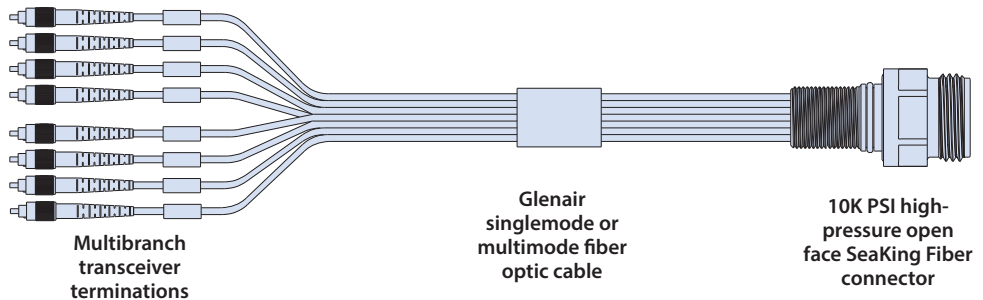

KEY AND KEYWAY POSITIONS

Alternate Keyway Positions		
Key Position	Key Rotation	
	A°	B°
Normal (N)	150°	210°
A	75°	210°
B	95°	230°
C	140°	275°

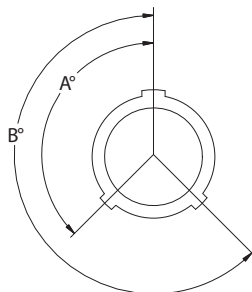

Plug (Key)

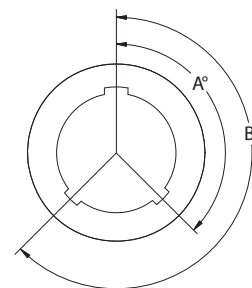

Receptacle (Keyway)



DEEP WATER SeaKing™ Fiber Optic



Fiber optic insert arrangements

Fiber Only

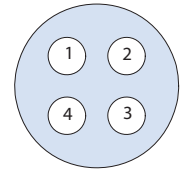
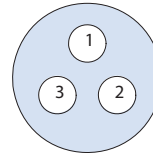
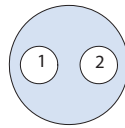

Shell Size	K	L	M
Insert Arrangement	KF2	LF3	MF4
No. of Contacts	2 FO	3 FO	4 FO

Fiber Only

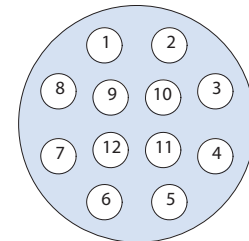
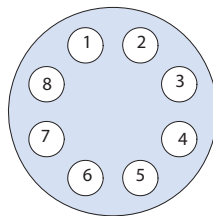

Shell Size	O	P
Insert Arrangement	OF8	PF12
No. of Contacts	8 FO	12 FO

Copper/Fiber

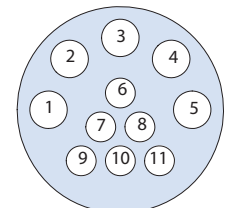
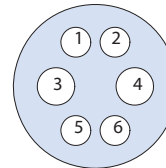
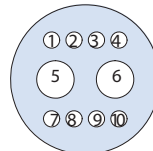
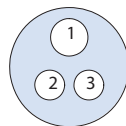

Shell Size	K	L	M	O
Insert Arrangement	KH12	LH28	MH24	OH56
No. of Fiber Contacts	1 FO	2 FO	2 FO	5 FO
No. of Copper Contacts	2 #16	8 #22	4 #16	6 #16

Copper/Fiber

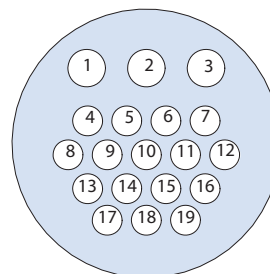
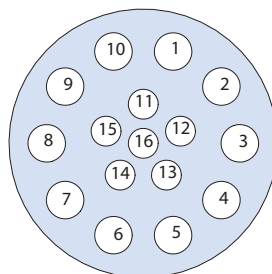

Shell Size	Q	Q
Insert Arrangement	QH106	QH316
No. of Fiber Contacts	10 FO	3 FO
No. of Copper Contacts	6 #16	16 #16

Contact Specifications		
Contact Size	#22	#16
Amps	3	10
Wire Gage Accommodation	22	16

All contact arrangements are rated for 600 volts.

Contact arrangements are shown as face view of receptacle insert. Contact arrangements of plug inserts are reverse.



DEEP WATER SeaKing™ Fiber Optic



Overmolded assemblies with SeaKing™ connectors or SeaKing™ to commercial fiber optic connectors

SeaKing Fiber - How To Order	
Sample Part Number	FA09648 -MF4 -Z1 -N -N -XXXX C -XXXX -CFM
Basic Number	SeaKing Fiber Optic overmolded plug jumper/breakout assembly
Shell Size & Insert Arrangement	See Glenair drawing 709-098
Shell Material	Z1 = 316 Stainless Steel (Consult Factory For Titanium or Peek Options)
P1 Connector Key Arrangement	(N, A, B, C)
P2 Connector Key Arrangement	(N, A, B, C) (1 = Blunt End Cable, Less P2 Connector, Backshell, & Overmold)
Length In Inches	See Standard Tolerance Table
Pressure Cap Option	C = Provided With Pressure Caps N = No Pressure Caps
Serial Number	Glenair Use Optional, Omit For None
CFM Option	Glenair Use Optional, Omit For None

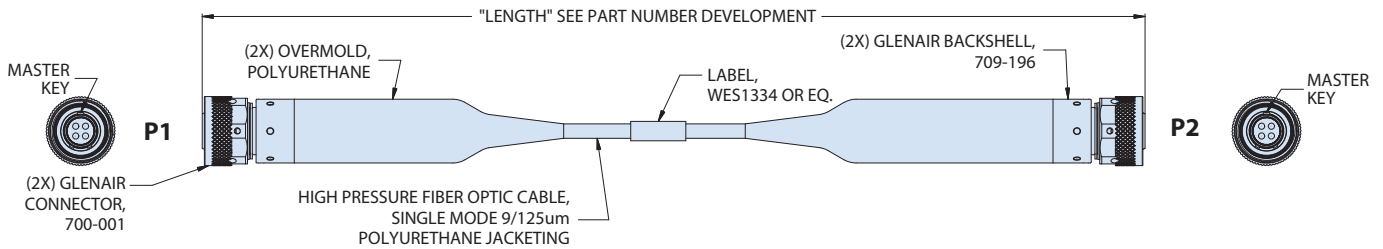

NOTES

- Optical performance: insertion loss shall be <1.0dB when measured @ 1310nm wavelength. Insertion loss can be measured at 1550nm upon customer request.
- Unit pack: 1 EA. In a bag and/or cardboard box, label package iaw illustration.
- Molding process for high pressure applications shall be used for polyurethane overmolds.
- See drawing 700-001 for connector dimensions, materials, and finishes; see drawing 709-196 for backshell dimensions, materials, and finishes; see drawing 709-098 for available insert arrangement.
- Wiring for each arrangement is one to one.
- Cables over 240" (20ft) shall be shipped on reel.
- Pressure rating up to 3,000 PSI.

Standard-Tolerance	
Length	Tolerance
Up to 24 In	+1 In -0
24 Up to 120 In	+3 In -0
120 Up to 600 In	+6 In -0
600 Up to 1200 In	+12 In -0
1200 In and Up	+24 In -0



DEEP WATER SeaKing™ Fiber Optic



SeaKing™ BCR or FCR to commercial fiber optic pigtail assembly for I/O-to-board module applications

SeaKing Fiber - How To Order	
Sample Part Number	FA09649 -B F Z1 -0F8 N -XXXX C
Basic Number	SeaKing Fiber Optic receptacle breakout assembly
J1 Option	B = BCR F = FCR
P1 Option	C = SC Leads F = FC Leads L = LC Leads N = None S = ST Leads
Shell Material	TC = Titanium Z1 = 316 Stainless Steel
Insert Arrangement	See Table I & II Insert Body Material: 316 SST
Key Arrangement	A, B, or C; N = normal,
Length	In inches (See Standard Tolerance Table)
Pressure Cap Option	C = Provided With Pressure Caps N = No Pressure Caps

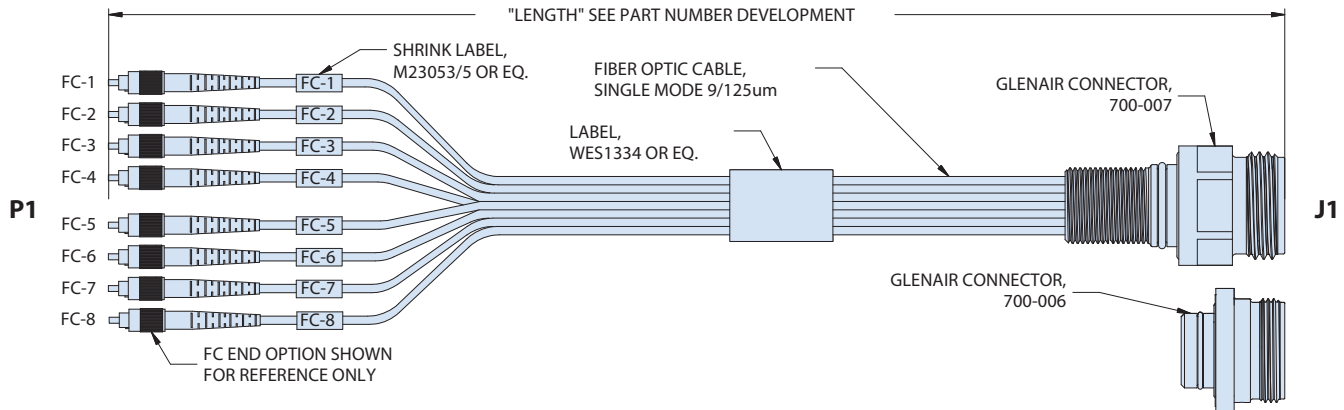

NOTES

- Optical performance:
Insertion loss shall be <1.0dB when measured @ 1310nm wavelength. Insertion loss can be measured at 1550nm upon customer request.
- Unit pack: 1 EA. In a bag and/or cardboard box, label package IAW illustration.
- Mark reference designators as shown. Reference designator number shall match the contact number.
- See drawing 700-006 and 700-007 for connector dimensions, materials, and finishes.
- Wiring for each arrangement is one to one.

END 2 COMMERCIAL FIBER OPTIC CONNECTOR OPTIONS

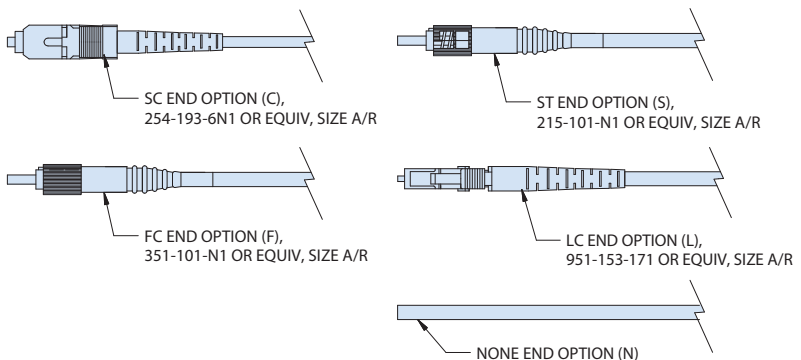



DEEP WATER SeaKing™ Fiber Optic



PBOF back-to-back SeaKing fiber optic assembly with straight, 45°, or 90° connectors

HOW TO ORDER	
Sample Part Number	FA09650 -MF4 -Z1 -N L 1 S -N L 1 S -XXXX C
Basic Number	SeaKing Fiber Optic PBOF point-to-point assembly
Shell Size & Insert Arrangements	See Insert Arrangements Table
Shell Material	Z1 = 316 Stainless Steel (Consult Factory For Titanium Or Peek Options)
P1 Connector Key Arrangements	(N, A, B, C)
P1 Backshell Style	L = Straight M = 45 Degree N = 90 Degree
P1 Fill Port Option	0 = No 1 = Yes
P1 Swivel/Fixed Option	F = Fixed S = Swivel
P2 Connector Key Arrangements	(N, A, B, C)
P2 Backshell Style	L = Straight M = 45 Degree N = 90 Degree
P2 Fill Port Option	0 = No 1 = Yes
P2 Swivel/Fixed Option	F = Fixed S = Swivel
Length	In inches (See Standard Tolerance Table)
Pressure Cap Option	C = Provided With Pressure Caps N = No Pressure Caps

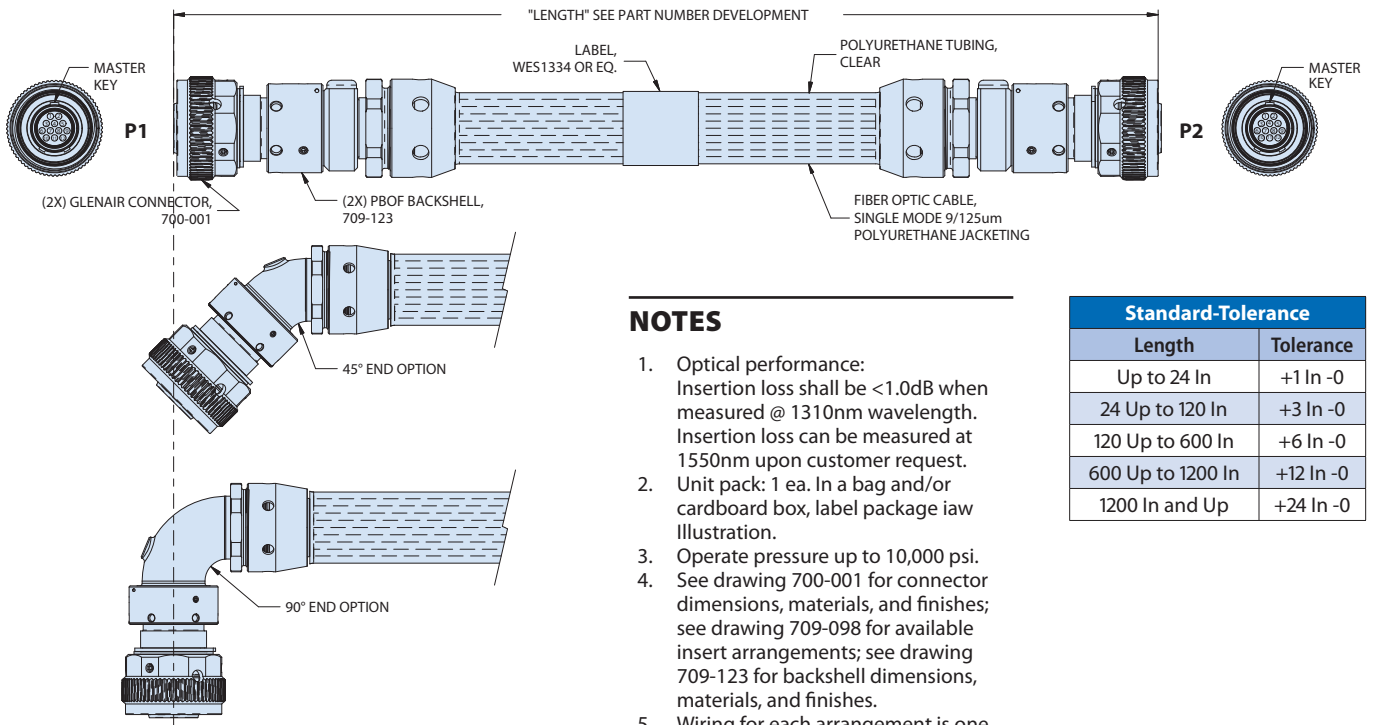

NOTES

- Optical performance: Insertion loss shall be <1.0dB when measured @ 1310nm wavelength. Insertion loss can be measured at 1550nm upon customer request.
- Unit pack: 1 ea. In a bag and/or cardboard box, label package iaw Illustration.
- Operate pressure up to 10,000 psi.
- See drawing 700-001 for connector dimensions, materials, and finishes; see drawing 709-098 for available insert arrangements; see drawing 709-123 for backshell dimensions, materials, and finishes.
- Wiring for each arrangement is one to one.

Standard-Tolerance

Length	Tolerance
Up to 24 In	+1 In -0
24 Up to 120 In	+3 In -0
120 Up to 600 In	+6 In -0
600 Up to 1200 In	+12 In -0
1200 In and Up	+24 In -0



DEEP WATER SeaKing™ Fiber Optic



PBOF single-ended fiber optic pigtail cable assembly with straight, 45°, and 90° routing

SeaKing Fiber - How To Order	
Sample Part Number	FA09781 -MF4 -Z1 -N L 1 S -N -XXXX C
Basic Number	SeaKing Fiber Optic PBOF Break-out Plug Assembly
Shell Size & Insert Arrangements	See Glenair Drawing 709-098
Shell Material	Z1 = 316 Stainless Steel (Consult Factory For Titanium Or Peek Options)
P1 Connector Key Arrangements	(N, A, B, C)
P1 Backshell Style	L = Straight M = 45 Degree N = 90 Degree
P1 Fill Port Option	0 = No 1 = Yes
P1 Swivel/Fixed Option	F = Fixed S = Swivel
P2 Option	F = FC Leads L = LC Leads N = None S = ST Leads
Length In Inches	In inches (See Standard Tolerance Table)
Pressure Cap Option	C = Provided With Pressure Caps N = No Pressure Caps

NOTES

- Optical performance: Insertion loss shall be <1.0dB when measured @ 1310nm wavelength. Insertion loss can be measured at 1550nm upon customer request.
- Unit pack: 1 ea. In a bag and/or cardboard box, label package iaw Illustration.
- Operate pressure up to 10,000 psi.
- See drawing 700-001 for connector dimensions, materials, and finishes; see drawing 709-098 for available insert arrangements; see drawing 709-123 for backshell dimensions, materials, and finishes.
- Wiring for each arrangement is one to one.

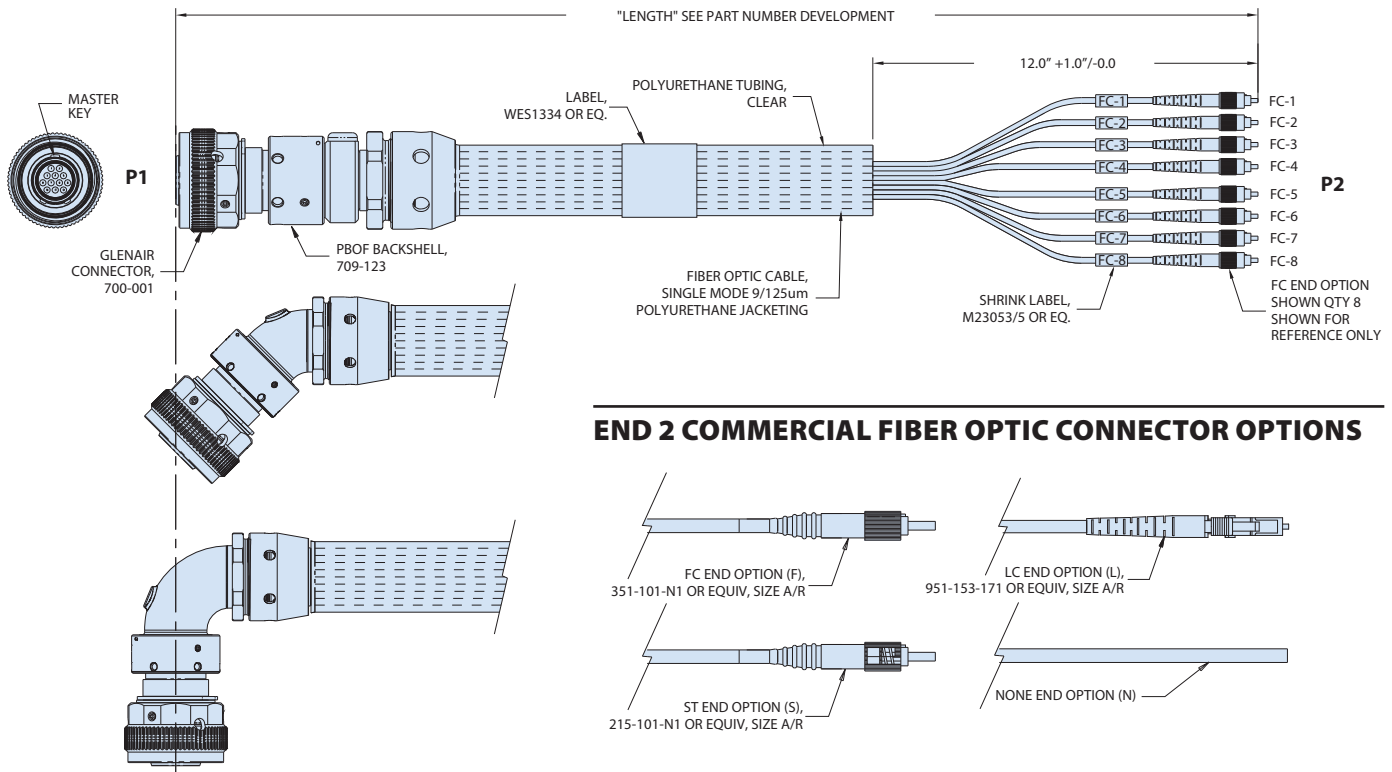



**DEEP
WATER**

SeaKing™ Power

1–6.6kV connectors for deep sea oil & gas primary power junctions



Glenair's SeaKing Power connector family is rated to 10K PSI in open-face or mated condition. These high-voltage (1–6.6kV) and high-amperage (up to 350 Amps) solder cup contact connectors are ready for immediate deployment in overmolded or PBOF configurations for primary power junction applications. Test reports available upon request. A range of shell sizes and contact inserts are available.

- **API 16D and 17E-compliant test ports**
- **Fully redundant dual O-ring sealing**
- **Indexable flange or threaded bulkhead designs**
- **O-ring pressure inspection ports available on all BCR and FCR designs**
- **Factory acceptance testing in both mated and open-face conditions**
- **Keyed mating interface for mismatch prevention**

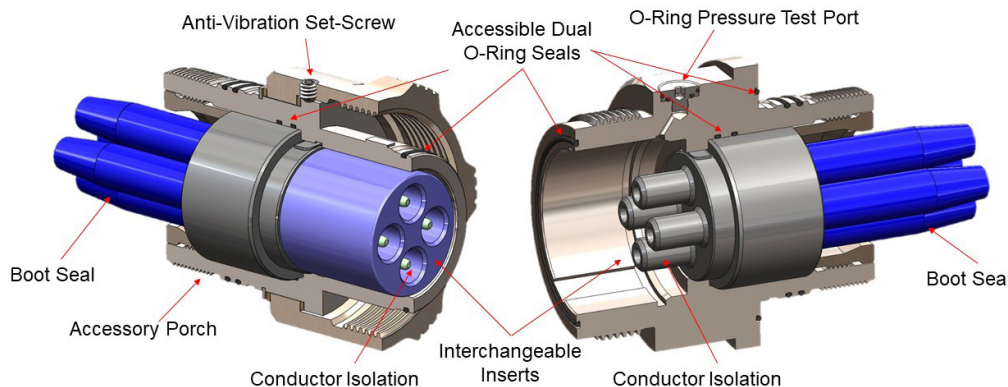



HIGH VOLTAGE SUBSEA

SeaKing™ Power connectors for underwater primary power junctions



Available configurations and applications

CABLE CONNECTOR PLUG (CCP)



SeaKing™ Power
API 16D and 17E-Compliant
Cable Connector Plug (CCP)

- PBOF and overmold compatible cable connector plug
- Super duplex stainless steel or titanium construction with glass-reinforced thermoplastic insulator
- Accepts various backshell accessories
- Aggressive coupling nut knurling for easy field mating
- Inspection ports, spanner wrench holes, and coupling nut lock set screws ensure reliable foolproof performance
- Mates with SeaKing Power receptacle assemblies with similar contact arrangement
- Conductor sealing boots protect solder cup wire-to-contact terminations in the event of a flooded hose

FLANGE CONNECTOR RECEPTACLE (FCR)



SeaKing™ Power
API 16D and 17E-Compliant
Flange Connector Receptacle (FCR)

- FCR delivers 10K PSI sealing in both mated and open-face condition
- Indexable flange allows receptacle shell rotation for 360° routing flexibility of right-angle-mating cable plugs
- Available API O-ring pressure test ports ensure reliability prior to deployment to ocean floor
- Super duplex stainless steel or titanium shells for complete compatibility with mating CCP
- Wire sealing boots ensure reliable environmental protection of cable-to-connector interface

BULKHEAD CONNECTOR RECEPTACLE (BCR)

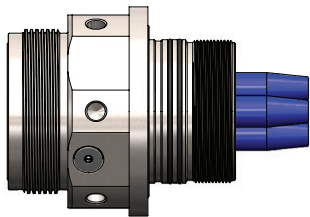

SeaKing™ Power
API 16D and 17E-Compliant
Bulkhead Connector Receptacle (BCR)

- BCR is designed for direct threaded bulkhead mounting
- Supplied washer, mounting nut, and bulkhead-mate O-ring seals ensure secure sealing and grounding to equipment housing
- BCR shell equipped with both wrench flats and spanner wrench holes for convenient installation regardless of tool choice
- Available API O-ring pressure test ports ensure reliability prior to deployment
- Mates with SeaKing Power CCP with similar contact arrangement

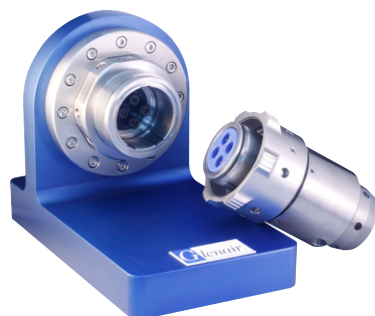

SeaKing™ Power Performance Specifications		
Pressure Rating	Plug: 10,000 PSI, mated condition Receptacles: 10,000 PSI mated and open face	per ISO 13628-6
Electrical	1–6.6kV, 350 Amps max per contact	per MIL-STD-202, Method 301
Materials	Salt Spray (corrosion) Humidity (steady state) Thermal Cycle	MIL-STD-202, Method 101 MIL-STD-202, Method 103 ISO 13628-6
Power Ratings	3kV, 50 Amp / contact 1kV, 50 Amp / contact 1kV, 150 Amp / contact 1kV, 350 Amp / contact	P/N 700-101-48, 700-106-48 P/N 707-0065, 707-0066 P/N 707-0088, 707-0089 P/N 707-0142



HIGH VOLTAGE SUBSEA SeaKing™ Power connectors for underwater primary power junctions



Size 48, 4-way #8 HV contacts, 3kV, 50 amps/contact

700-101-48 SEAKING POWER, CABLE CONNECTOR PLUG (CCP), SIZE 48, 4-WAY #8 HV CONTACTS*

How to Order	
Sample Part Number	700-101 -48HV4 Z1 S N
Series	700-101 = cable connector plug
Shell Size / Insert Arrangement	-48HV4 = shell size 48 / layout HV4
Shell Material	Z1 = SS super duplex TC = titanium
Contact Style	P = pins S = sockets
Polarization	N = normal, A, B, C; see key positions table at right

Key Positions		
Position	A	B
N	150°	210°
A	75°	210°
B	95°	230°
C	140°	275°

*Mates only with 700-106 BCR or FCR

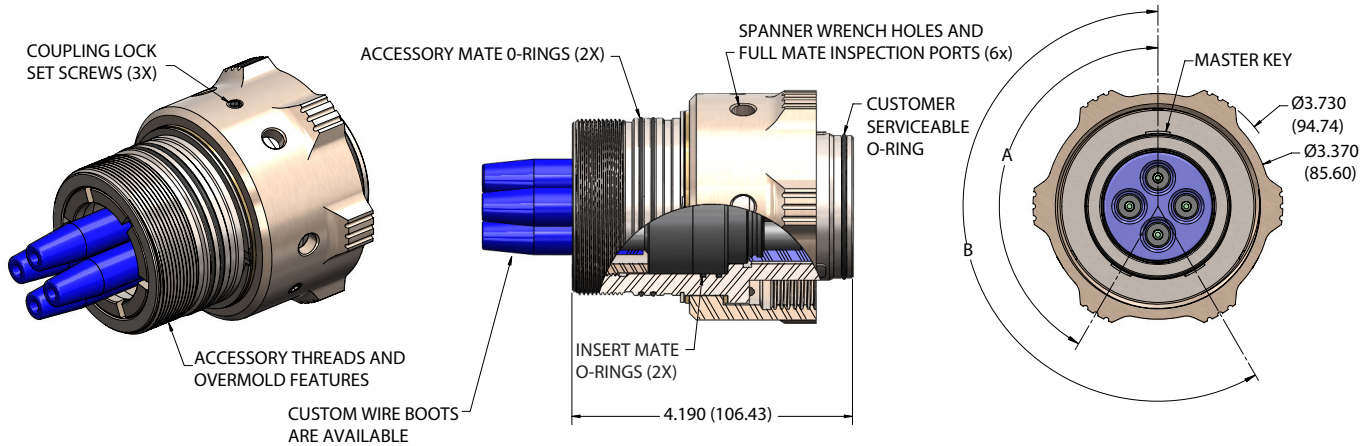



HIGH VOLTAGE SUBSEA SeaKing™ Power connectors for underwater primary power junctions



Size 48, 4-way #8 HV contacts, 3kV, 50 amps/contact

700-106-48 SEAKING POWER, FLANGE OR BULKHEAD CONNECTOR RECEPTACLE (FCR OR BCR), SIZE 48, 4-WAY #8 HV CONTACTS*

How to Order	
Sample Part Number	700-106 -48HV4 Z1 S N B
Series	700-106 = bulkhead or flange connector receptacle (BCR OR FCR)
Shell Size / Insert Arrangement	-48HV4 = shell size 48 / layout HV4
Shell Material	Z1 = SS super duplex TC = titanium
Contact Style	P = pins S = sockets
Polarization	N = normal, A, B, C; see key positions table at right
Mounting Option*	B = BCR option includes bulkhead nut and washer F = FCR option and includes indexable mounting flange (fastener not included) N = None, receptacle is mountable to a threaded bulkhead
Shell Option*	API = test ports; omit for none

Key Positions		
Position	A	B
N	150°	210°
A	75°	210°
B	95°	230°
C	140°	275°

*Mates only with 700-101 Cable Connector Plug

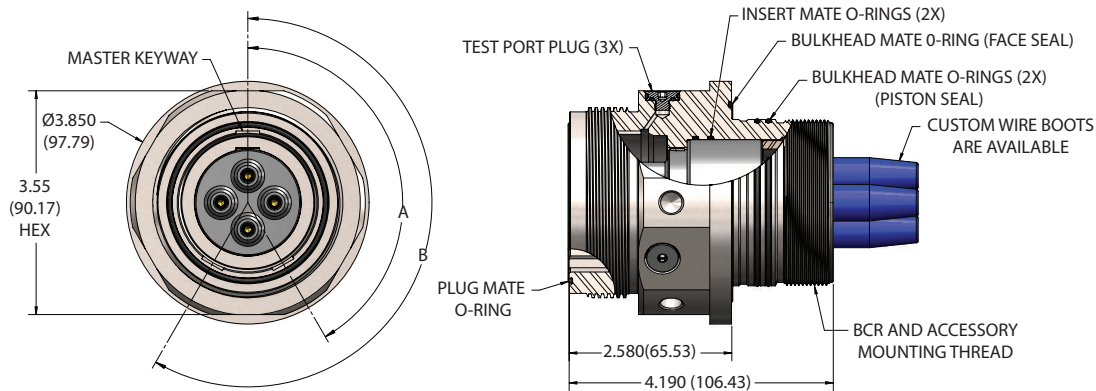



HIGH VOLTAGE SUBSEA SeaKing™ Power connectors for underwater primary power junctions



Size P, 4-way #8 HV contacts, 1kV, 50 amps/contact

707-0065-P4 SEAKING POWER, CABLE CONNECTOR PLUG (CCP)*

How to Order					
Sample Part Number	707-0065	-P4	-Z1	S	N
Series	707-0065 = cable connector plug (CCP)				
Shell Size / Insert Arrangement	P4				
Shell Material	Z1 = stainless steel TC = titanium				
Contact Style	P = pin (707-0066 only) S = socket (707-0065 only)				
Polarization	N = Normal, A, B, C; see key positions table at right				

Key Positions		
Position	A	B
N	150°	210°
A	75°	210°
B	95°	230°
C	140°	275°

*Mates only with 707-0066 BCR

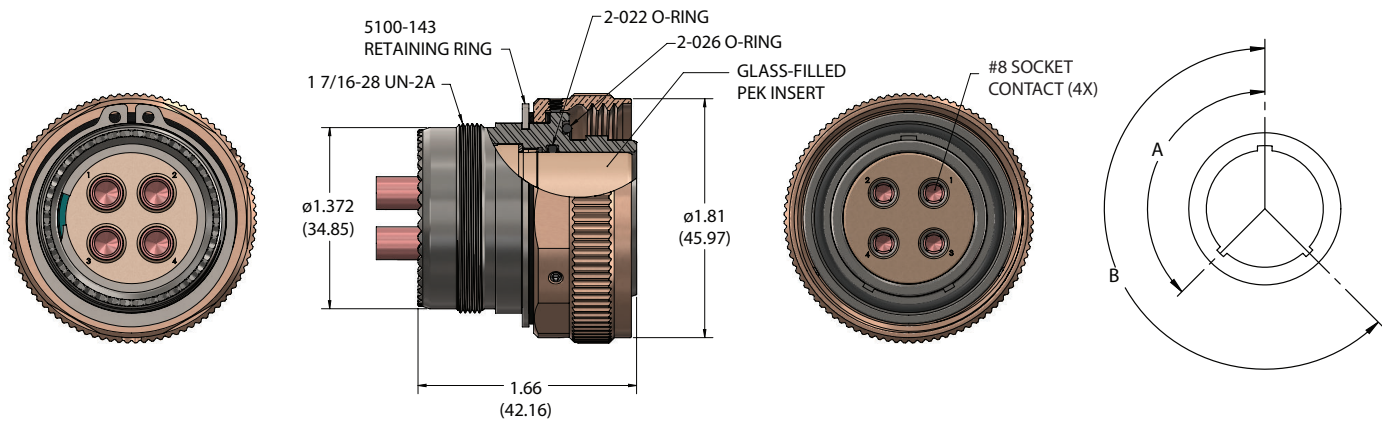

707-0066-P4 SEAKING POWER, BULKHEAD CONNECTOR RECEPTACLE (BCR)*

How to Order					
Sample Part Number	707-0066	-P4	-Z1	S	N
Series	707-0066 = bulk head receptacle (BCR)				
Shell Size / Insert Arrangement	P4				
Shell Material	Z1 = stainless steel TC = titanium				
Contact Style	P = pin (707-0066 only) S = socket (707-0065 only)				
Polarization	N = Normal, A, B, C; see key positions table				

Key Positions		
Position	A	B
N	150°	210°
A	75°	210°
B	95°	230°
C	140°	275°

*Mates only with 707-0065 CCP

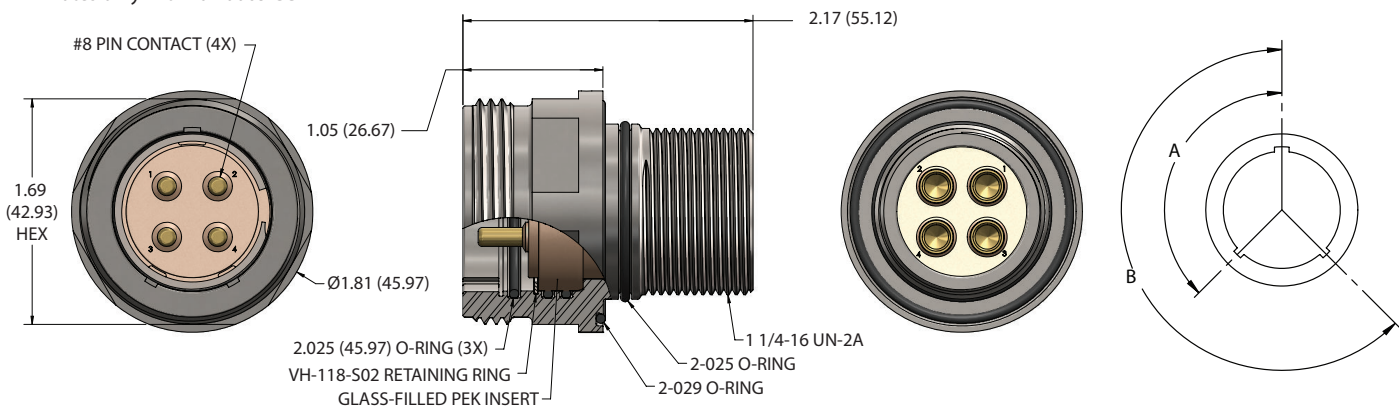



HIGH VOLTAGE SUBSEA SeaKing™ Power connectors for underwater primary power junctions



Size 32, 1-way #1/0 HV contact, 1kV, 150 amps/contact

707-0088 SEAKING POWER, CABLE CONNECTOR PLUG (CCP), SIZE 32, 1-WAY #1/0 HV CONTACTS*

How to Order	
Sample Part Number	707-0088 Z1 P N
Series	707-0088 = cable connector plug
Shell Material	Z1 = stainless steel TC = titanium
Contact Style	P = pin S = socket
Polarization	N = normal, A, B, C; see key positions table at right

Key Positions		
Position	A	B
N	150°	210°
A	75°	210°
B	95°	230°
C	140°	275°

*Mates only with 707-0089 FCR or BCR

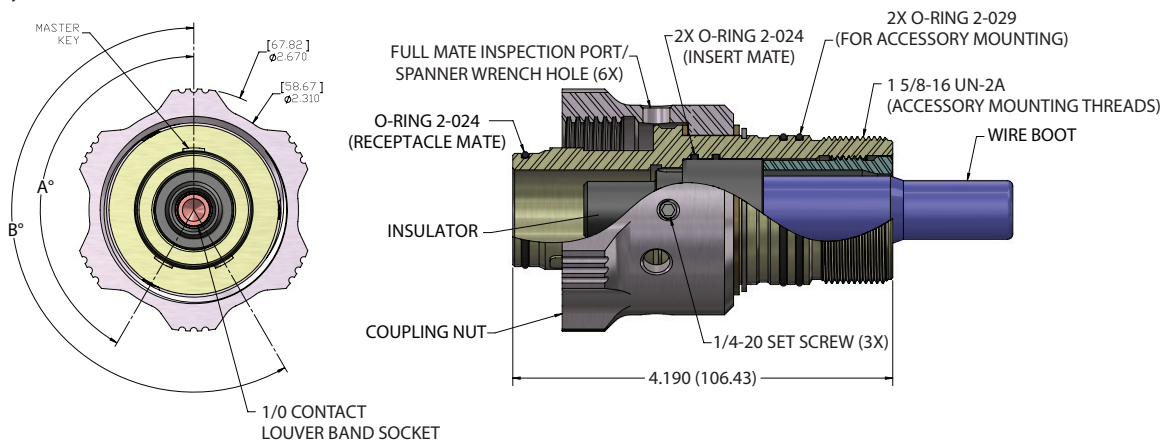

707-0089 SEAKING POWER, FCR/BCR, SIZE 32, 1-WAY #1/0 CONTACTS*

How to Order	
Sample Part Number	707-0089 Z1 P N -N -API
Series	707-0089 = flange connector receptacle or bulkhead connector receptacle
Shell Material	Z1 = stainless steel TC = titanium
Contact Style	P = pin S = socket
Polarization	N = normal, A, B, C; see key positions table at right
Mounting Option*	B = BCR option and includes bulkhead nut and washer F = FCR option and includes indexable mounting flange N = none, receptacle is mountable to a threaded bulkhead
Shell Option*	API = test ports; omit for none

Key Positions		
Position	A	B
N	150°	210°
A	75°	210°
B	95°	230°
C	140°	275°

*Mates only with 707-0088 CCP

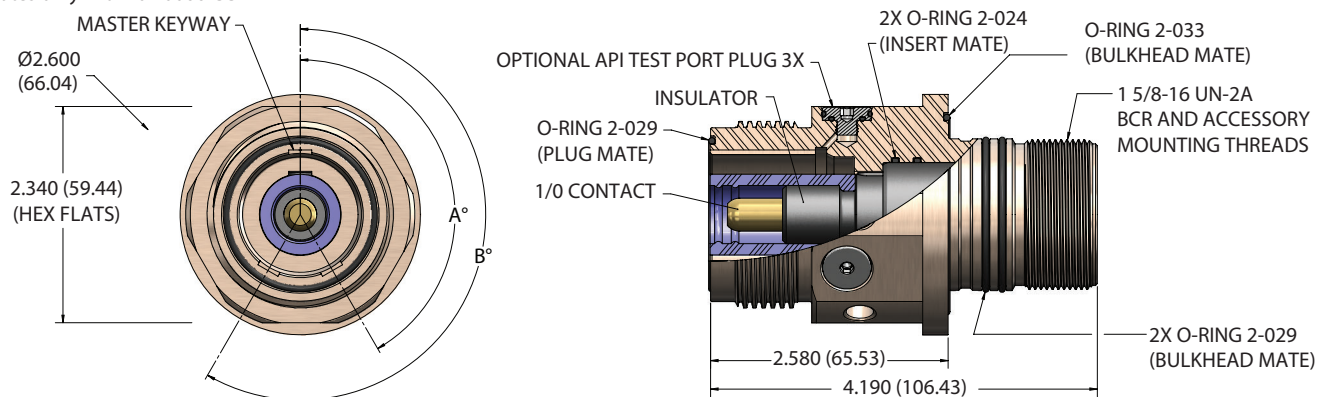



HIGH VOLTAGE SUBSEA SeaKing™ Power connectors for underwater primary power junctions



Size 64, 4-way #4/0 HV contact, 1kV, 350 amps/contact

How to Order			
Sample Part Number	707-0142	1	N
Series	707-0142 = SeaKing Power		
Connector Style	-1 = cable connector plug (CCP) -6 = flange connector receptacle (FCR) -7 = bulkhead connector receptacle (BCR)		
Key Position	N = normal, A, B, C; see key positions table		

Key Positions		
Position	A	B
N	150°	210°
A	75°	210°
B	95°	230°
C	140°	275°

707-0142-1 SEAKING POWER, CABLE CONNECTOR PLUG (CCP), SIZE 64, 4-WAY #4/0 HV CONTACTS*

*Mates only with 707-0142-6 FCR or 707-0142-7 BCR

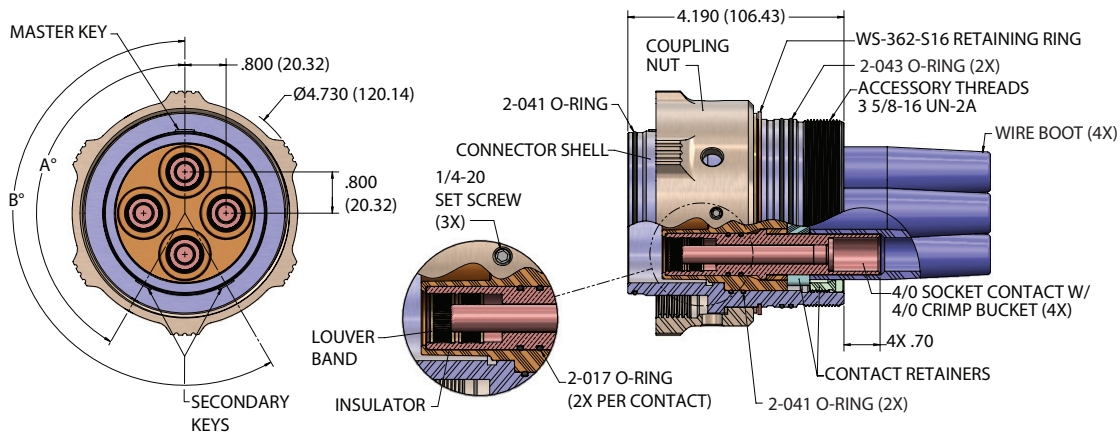

707-0142-7 SEAKING POWER, BULKHEAD CONNECTOR RECEPTACLE (BCR), SIZE 64, 4-WAY #4/0 HV CONTACTS*

*Mates only with 707-0142-1 CCP

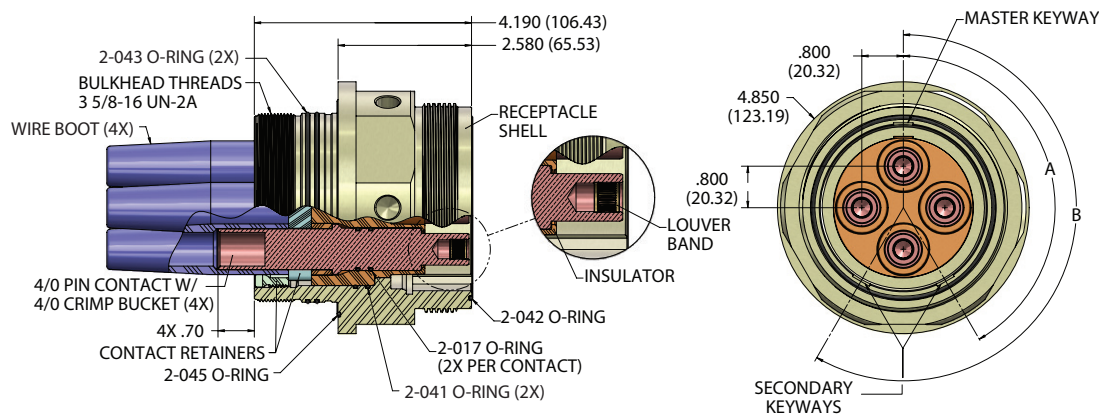



HIGH VOLTAGE SUBSEA SeaKing™ Power connectors for underwater primary power junctions



Size 64, 4-way #4/0 HV contact, 1kV, 350 amps/contact

707-0142-6 SEAKING POWER, FLANGE CONNECTOR RECEPTACLE (FCR), SIZE 64, 4-WAY #4/0 HV CONTACTS*

*Mates only with 707-0142-1 CCP

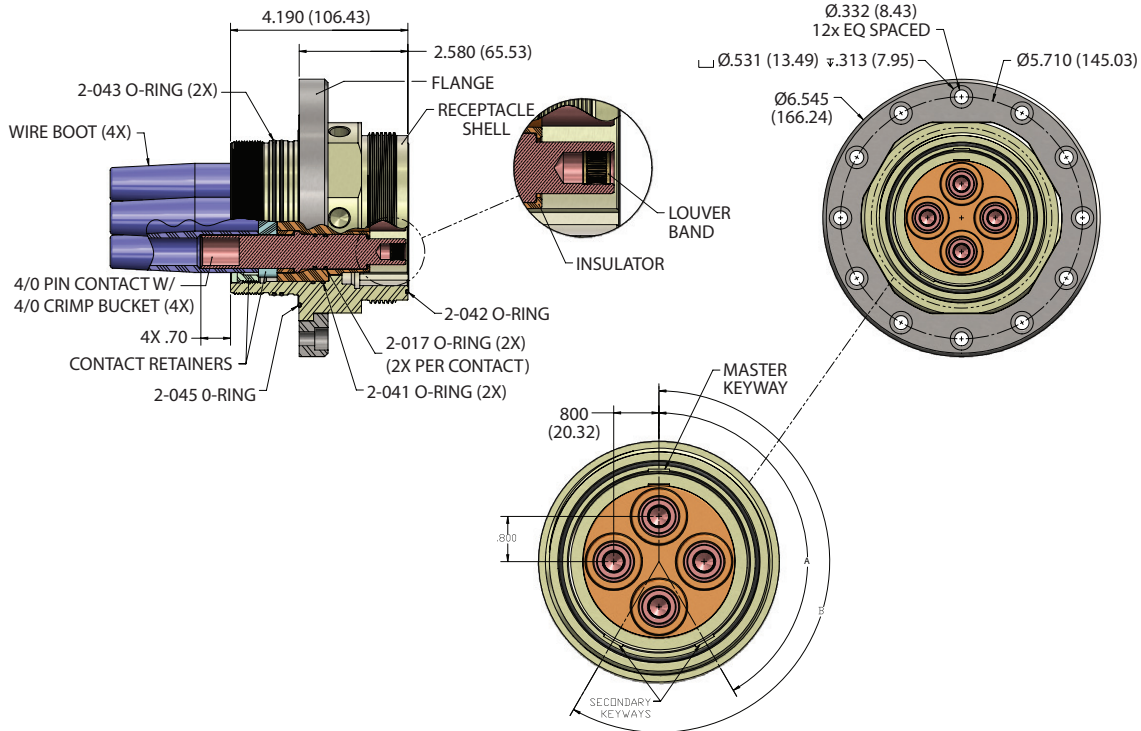



**DEEP
WATER**

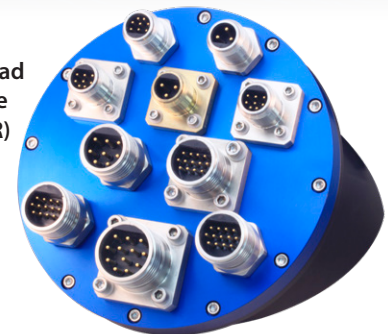

Photo: NOAA



ADVANCED PERFORMANCE SERIES 55 TYPE 10K PSI SuperG55™

High-pressure
open face bulkhead
(BCR) and flange
receptacles (FCR)



The SuperG55™ family of dry-mate underwater deep-sea high-pressure connectors are a revolutionary new design of the popular industry-standard used in countless ROV, underwater camera, diver communications, lights, pan and tilts, and other deep subsea applications.

Available in multiple shell sizes, the SuperG55™ is manufactured from 316L Stainless Steel with insert molded contact assemblies designed for pressure-sealed applications up to 10K PSI mated and unmated. Intermateable and intermountable with other "55" series connectors, the Glenair solution introduces a long list of product innovations designed to improve performance and durability. Our PBOF versions, for example, utilize

easy-to-assemble threaded fittings which deliver both superior sealing performance while reducing installation time. Other innovations include full-mate inspection ports, improved solder cup contact design and more. Cable plugs and receptacles available in attachable (user-terminatable) versions as well as factory overmolded single-ended whips.

- 10,000 PSI mated/unmated (approx. 22,500ft/7,000m)
- Recessed socket contacts in plugs for electrical safety
- Intermateable and intermountable with other "55" series connectors
- 4 shell sizes — 15, 20, 24 and 32 with 3 to 39 contacts
- PBOF versions available
- 600 VDC, 5 to 18 Amps (dependent on conductor and cable size and make-up)



Bulkhead Connector Receptacle (BCR)



Factory-terminated overmolded Cable Connector Plug (CCP)



Flange Connector Receptacle (FCR)



10K PSI / 700 BAR / 7000M Advanced-Performance Series 55 Type SuperG55 10K PSI



Key mechanical and environmental features

SUPERG55™ PRESSURE-BALANCED OIL-FILLED CABLE CONNECTOR PLUG (CCP)

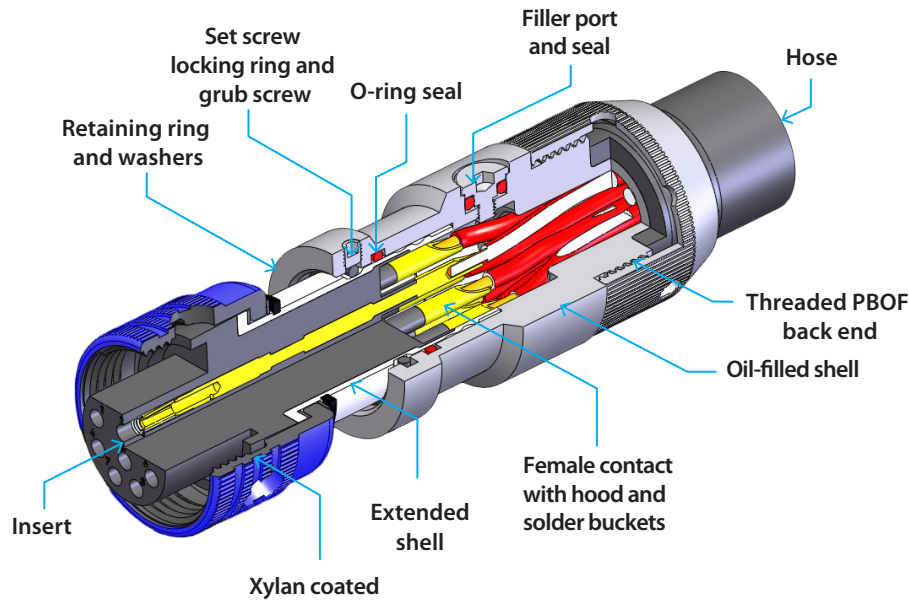

SuperG55™ Performance Specifications	
Mating Cycles	500
Pressure	689 Bar (10,000 PSI) Mated and Un-mated
Operating Temperature	-20°C to +90°C
Voltage Rating	600 VDC / 440 Vac
Current (max.)	5 to 18 Amps (dependant on contact and cable conductor sizes)

SuperG55™ Material/Finish	
Shells	316L Stainless Steel/ Passivated
Insulator	PEEK/NA
Insert	Neoprene/NA
Contacts	Copper Alloy/Gold Plated
O-rings	Nitrile/NA
Overmold and Cable	Polyurethane or Neoprene/NA
Coupling Nut	316L Stainless Steel/ Protective Coating Blue
Bulkhead Receptacle Tails	PTFE Insulated 16 AWG Wire/NA
Cable	Polyurethane or Neoprene Jacketed/NA

SUPERG55™ FLANGE CONNECTOR RECEPTACLE (FCR)

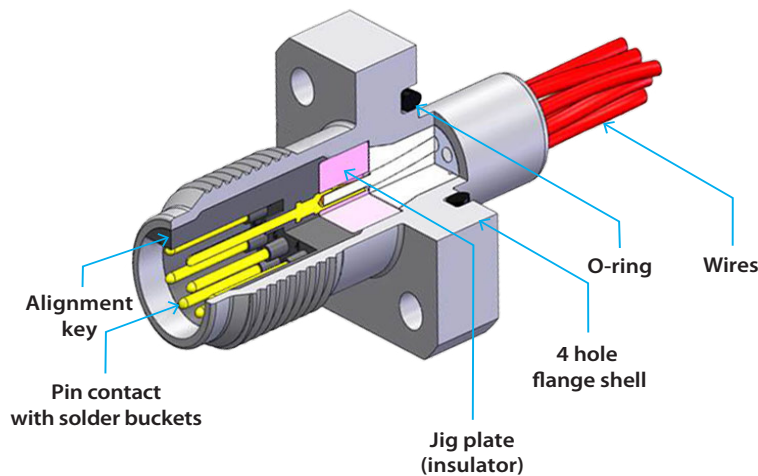

NON-STANDARD MATERIALS: Other material options are available as part of our non-catalog offerings including anodized aluminum, titanium, and aluminum bronze. Glenair is also able to supply SuperG55™ interconnects in composite thermoplastic (PEEK) to meet application requirements for reduced cathodic corrosion as well as weight reduction without affecting connector performance.

HIGH-SPEED ETHERNET: The SuperG55™ Ethernet option is available in the 1508, 2013 and 2022 contact configurations and provides both high speed (Up to 1GB) and power (600 Volts) in a full subsea environment (10,000 PSI). Gigabit speed data transfer up to a distance of 75mtrs.

Material Finish Codes			
Code	Material/Finish	Code	Material/Finish
	Anodized Aluminum	PK	Composite Thermoplastic (PEEK)
NAB2	Aluminum Bronze	B	Brass
T	Titanium	Alternative materials available, contact factory	



10K PSI / 700 BAR / 7000M Advanced-Performance Series 55 Type SuperG55 10K PSI Insert arrangements



SUPERG55™ INSERT ARRANGEMENTS Mating face view of pin insert (socket insert IDs are reversed)

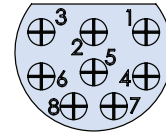
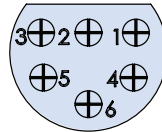
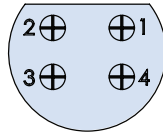
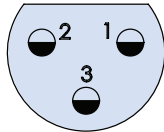

Shell Size 15

1503

3 Size #12 AWG
Contacts

1504

4 Size #16 AWG
Contacts

1506

6 size #16 AWG
Contacts

1508*

8 size #16 AWG
Contacts

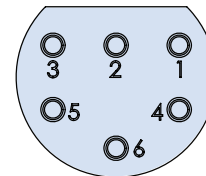
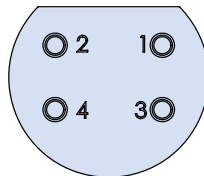
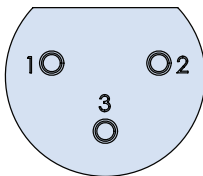

Shell Size 20

2003

3 Size #10 AWG
Contacts

2004

4 Size #10 AWG
Contacts

2006

6 Size #10 AWG
Contacts

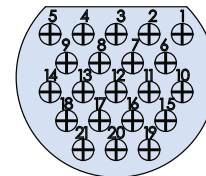
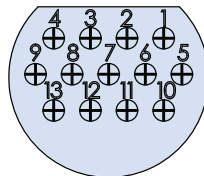
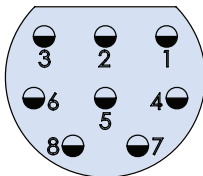

Shell Size 20

2008*

8 Size #12 AWG
Contacts

2013*

13 Size #16 AWG
Contacts

2022*

21 Size #16 AWG
Contacts

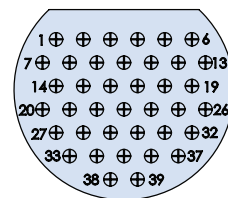
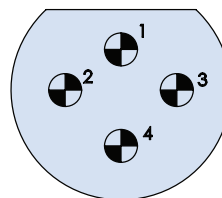
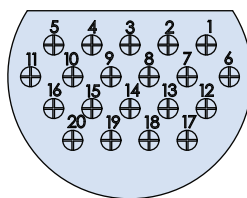
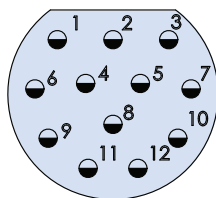

Shell Size 24

2412

12 Size #12 AWG
Contacts

2420

20 Size #16 AWG
Contacts

Shell Size 32

3204***

4 Size #6 AWG
Contacts

3239**

39 Size #16 AWG
Contacts

Bulkhead Mounting Torque (Values are for dry non-lubricated threads)	Size 15 - 14.12NM (125LB. INS.)
	Size 20 - 18.64NM (165LB.INS.)
	Size 24 - 25.42NM (225LB.INS.)
	Size 32 - TBD

*Compatible with high-speed Ethernet
 **3239 is not intermateable with any other brand of
 connector. Contact factory for details
 *** Contact factory for availability
 Custom insert arrangements available, contact factory.



10K PSI / 700 BAR / 7000M
Advanced-Performance
Series 55 Type SuperG55 10K PSI
SuperG55 Series connectors



G55 A1 ATTACHABLE CABLE CONNECTOR PLUG (CCP)



SuperG55™ - How To Order	
Sample Part Number	G55A1 -1508 -0000
Series	SuperG55™ = underwater dry-mate, long version (CCP), attachable
Shell Size/Insert Arrangement Size	See shell size / insert arrangements (page 48)
Overall Length	In feet (0000 = no cable, 0001 = one foot, etc.)
Potting Boot	PB = potting boot; omit for none. Not required if used for OFR1
Material Option	Omit for stainless steel B = brass coupling nut and barrel PK = peek coupling nut and barrel See material options on page 47

G55 01 STRAIGHT OVERMOLDED, CABLE PLUG (CCP)



SuperG55™ - How To Order	
Sample Part Number	G5501 -1508 -0004
Series	SuperG55™ = underwater dry-mate, straight overmolded CCP
Shell Size/Insert Arrangement	See shell size / insert arrangements (page 48)
Cable Length	In feet (0001 = one foot, 0002 = two feet etc.)
Inch Increments	3, 6 or 9 inches; omit for whole feet lengths
Material Option	Omit for stainless steel B = brass coupling nut and barrel PK = peek coupling nut and barrel See material options on page 47
Back-to-Back	B2B = back-to-back; omit if not required

G55 R1 RIGHT ANGLE OVERMOLDED, CABLE CONNECTOR PLUG (CCP)



SuperG55™ - How To Order	
Sample Part Number	G55R1 -1508 -0004
Series	SuperG55™ = underwater dry-mate, right angle overmolded CCP
Shell Size/Insert Arrangement	See shell size / insert arrangements (page 48)
Cable Length	In feet (0001 = one foot, 0002 = two feet etc.)
Inch Increments	3, 6 or 9 inches; omit for whole feet lengths
Material Option	Omit for stainless steel B = brass coupling nut and barrel PK = peek coupling nut and barrel See material options on page 47
Back-to-Back	B2B = back-to-back; omit if not required



10K PSI / 700 BAR / 7000M
Advanced-Performance
Series 55 Type SuperG55 10K PSI
SuperG55 Series connectors



G55 OF1 STRAIGHT OIL-FILLED CABLE CONNECTOR PLUG (CCP)



SuperG55™ - How To Order				
Sample Part Number	G55OF1	-1508	-0010	
Series	SuperG55™ = Underwater dry-mate, straight oil-filled CCP			
Shell Size/Insert Arrangement	See shell size / insert arrangements (page 48)			
Overall Length	In feet (0000 = no cable, no hose 0001 = one foot, etc.)			
Back-to-Back*	B2B = back-to-back (min. 7ft hose length); omit if not required			

*Consult factory for additional back-to-back options

G55 OFR1 RIGHT ANGLE OIL-FILLED CABLE CONNECTOR PLUG (CCP)



SuperG55™ - How To Order				
Sample Part Number	G55OFR1	-1508	-0010	
Series	SuperG55™ = Underwater dry-mate, right angle oil-filled CCP			
Shell Size/Insert Arrangement	See shell size / insert arrangements (page 48)			
Overall Length	In feet (0000 = no cable, no hose 0001 = one foot, etc.)			
Back-to-Back*	B2B = back-to-back (min. 7ft hose length); omit if not required			

*Consult factory for additional back-to-back options

G55 06 FLANGE CONNECTOR RECEPTACLE (FCR)



SuperG55™ - How To Order				
Sample Part Number	G5506	-2013	-0004	
Series	SuperG55™ = underwater dry-mate, flange connector receptacle (FCR)			
Shell Size/Insert Arrangement	See shell size / insert arrangements (page 48)			
Cable Length	In feet (0001 = 1 foot, 0004 = 4 feet, standard length)			
Material Option	Omit for stainless steel B = brass coupling nut and barrel	PK = peek coupling nut and barrel See material options on page 47		



10K PSI / 700 BAR / 7000M
Advanced-Performance
Series 55 Type SuperG55 10K PSI
SuperG55 Series connectors



G55 07 BULKHEAD CONNECTOR RECEPTACLE (BCR)



SuperG55™ - How To Order				
Sample Part Number	G5507	-1508	-0004	
Series	SuperG55™ = underwater dry-mate, bulkhead connector receptacle (BCR)			
Shell Size/Insert Arrangement	See shell size / insert arrangements (page 48)			
Cable Length	In feet (0001 = 1 foot, 0004 = 4 feet, standard length)			
Material Option	Omit for stainless steel B = brass coupling nut and barrel		PK = peek coupling nut and barrel See material options on page 47	

G55 A2 ATTACHABLE CABLE CONNECTOR RECEPTACLE (CCR)

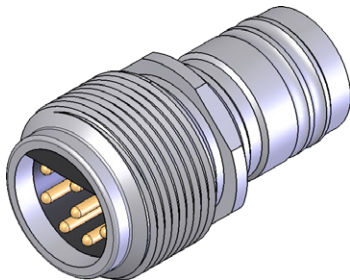

SuperG55™ - How To Order				
Sample Part Number	G55A2	-1508	-0000	
Series	SuperG55™ = underwater dry-mate, attachable cable connector receptacle (CCR)			
Shell Size/Insert Arrangement	See shell size / insert arrangements (page 48)			
Cable Length	In feet (0000 = no cable, 0001 = one foot, etc.)			
Material Option	Omit for stainless steel B = brass coupling nut and barrel		PK = peek coupling nut and barrel See material options on page 47	

*Currently only 1504, 1506, 1508, 2013, 2022 & 2420 insert arrangements are available.

G55 02 STRAIGHT OVERMOLDED CABLE CONNECTOR RECEPTACLE (CCR)



SuperG55™ - How To Order					
Sample Part Number	G5502	-1508	-0004		
Series	SuperG55™ = underwater dry-mate, straight overmolded CCR				
Shell Size/Insert Arrangement	See shell size / insert arrangements (page 48)				
Cable Length	In feet (0001 = one foot, 0002 = two feet etc.)				
Inch Increments	3, 6 or 9 inches; omit for whole feet lengths				
Material Option	Omit for stainless steel B = brass coupling nut and barrel		PK = peek coupling nut and barrel See material options on page 47		
Back-to-Back	B2B = back-to-back; omit if not required				



10K PSI / 700 BAR / 7000M
Advanced-Performance
Series 55 Type SuperG55 10K PSI
SuperG55 Series connectors



G55 R2 RIGHT ANGLE OVERMOLDED CABLE CONNECTOR RECEPTACLE (CCR)



SuperG55™ - How To Order				
Sample Part Number	G55R2	-1508	-0004	
Series	SuperG55™ = underwater dry-mate, right angle overmolded CCR			
Shell Size/Insert Arrangement	See shell size / insert arrangements (page 48)			
Cable Length	In feet (0001 = one foot, 0002 = two feet etc.)			
Inch Increments	3, 6 or 9 inches; omit for whole feet lengths			
Material Option	Omit for stainless steel B = brass coupling nut and barrel		PK = peek coupling nut and barrel See material options on page 47	
Back-to-Back	B2B = back-to-back; omit if not required			

G55 OF2 STRAIGHT OIL-FILLED CABLE CONNECTOR RECEPTACLE (CCR)



SuperG55™ - How To Order				
Sample Part Number	G55OF2	-1508	-0010	
Series	SuperG55™ = Underwater dry-mate, straight oil-filled CCR			
Shell Size/Insert Arrangement*	See shell size / insert arrangements (page 48)			
Overall Length	In feet (0000 = no cable, no hose, 0001 = one foot, etc.)			
Back-to-Back**	B2B = back-to-back (min. 7ft hose length); omit if not required			

*Currently only 1504, 1506, 1508, 2013, 2022, and 2420 insert arrangements are available
 **Consult factory for additional back-to-back options

G55 OFR2 RIGHT ANGLE OIL-FILLED CABLE CONNECTOR RECEPTACLE (CCR)



SuperG55™ - How To Order				
Sample Part Number	G55OFR2	-1508	-0010	
Series	SuperG55™ = Underwater dry-mate, right angle oil-filled CCR			
Shell Size/Insert Arrangement*	See shell size / insert arrangements (page 48)			
Overall Length	In feet (0000 = no cable, no hose, 0001 = one foot, etc.)			
Back-to-Back*	B2B = back-to-back (min. 7ft hose length); omit if not required			

*Currently only 1504, 1506, 1508, 2013, 2022, and 2420 insert arrangements are available
 **Consult factory for additional back-to-back options



10K PSI / 700 BAR / 7000M
Advanced-Performance
Series 55 Type SuperG55 10K PSI
SuperG55 Series connectors



G55 D1 DUMMY SEALING PLUG (DSP)



SuperG55™ - How To Order				
Sample Part Number	G55D1	-1508	-0000	
Series	SuperG55™ = dummy sealing plug (DSP)			
Shell Size/Insert Arrangement	See shell size / insert arrangements (page 48)			
Cable Length	0000 = no cable			
Material Option	Omit for stainless steel B = brass coupling nut and barrel		PK = peek coupling nut and barrel See material options on page 47	

G55 D2 DUMMY SEALING RECEPTACLE (DSR)

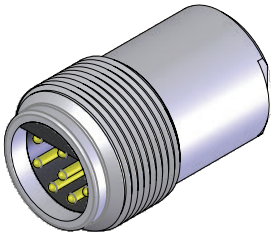

SuperG55™ - How To Order				
Sample Part Number	G55D2	-1508	-0000	
Series	SuperG55™ = dummy sealing receptacle (DSR)			
Shell Size/Insert Arrangement	See shell size / insert arrangements (page 48)			
Cable Length	0000 = no cable			
Material Option	Omit for stainless steel B = brass coupling nut and barrel		PK = peek coupling nut and barrel See material options on page 47	

G55 M1 SOCKET TO SOCKET (CCP)

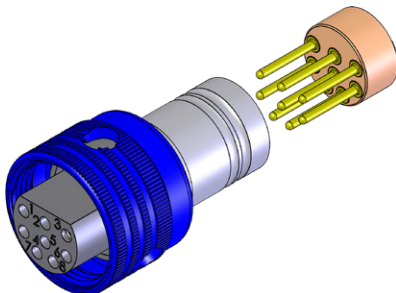

SuperG55™ - How To Order				
Sample Part Number	G55M1	-1508	-0001	
Series	SuperG55™ = underwater dry-mate, back-to-back socket CCP			
Shell Size/Insert Arrangement	See shell size / insert arrangements (page 48)			
Cable Length	In feet (0000 = no cable, 0001 = one foot, etc.)			
Material Option	Omit for stainless steel B = brass coupling nut and barrel		PK = peek coupling nut and barrel See material options on page 47	



10K PSI / 700 BAR / 7000M
Advanced-Performance
Series 55 Type SuperG55 10K PSI
SuperG55 Series custom connectors



G55 06 FLANGE CONNECTOR RECEPTACLE (FCR) WITH EARTH LEAD

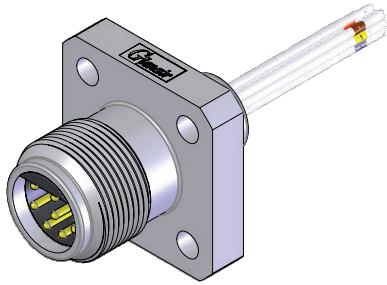

SuperG55™ - How To Order					
Sample Part Number	G5506	-1508	-0004	-EL	
Series	SuperG55™ = underwater dry-mate, FCR with earth lead				
Shell Size/Insert Arrangement	See shell size / insert arrangements (page 48)				
Cable Length	In feet (0001 = 1 foot, 0004 = 4 feet, standard length)				
Earth Lead	EL = earth lead (ground)				
Material Option	T = titanium; omit for stainless steel				

G55 07 BULKHEAD CONNECTOR RECEPTACLE (BCR) WITH EARTH LEAD



SuperG55™ - How To Order					
Sample Part Number	G5507	-1508	-0004	-EL	
Series	SuperG55™ = underwater dry-mate, BCR with earth lead				
Shell Size/Insert Arrangement	See shell size / insert arrangements (page 48)				
Cable Length	In feet (0001 = 1 foot, 0004 = 4 feet, standard length)				
Earthing Lead	EL = earth lead (ground)				
Material Option	T = titanium; omit for stainless steel				

G55 061F FLANGE CONNECTOR RECEPTACLE (FCR) WITH INDEXABLE FLANGE



SuperG55™ - How To Order					
Sample Part Number	G55061F	-1508	-0004		
Series	SuperG55™ = underwater dry-mate, flange connector receptacle (FCR) with indexable flange				
Shell Size/Insert Arrangement	See shell size / insert arrangements (page 48)				
Cable Length	In feet (0001 = 1 foot, 0004 = 4 feet, standard length)				
Material Option	Omit for stainless steel B = brass coupling nut and barrel		PK = peek coupling nut and barrel See material options on page 47		



10K PSI / 700 BAR / 7000M
Advanced-Performance
Series 66 Type SuperG66 10K PSI
SuperG66 reverse-gender connectors



G66 OVERMOLDED CABLE CONNECTOR PLUGS AND RECEPTACLES

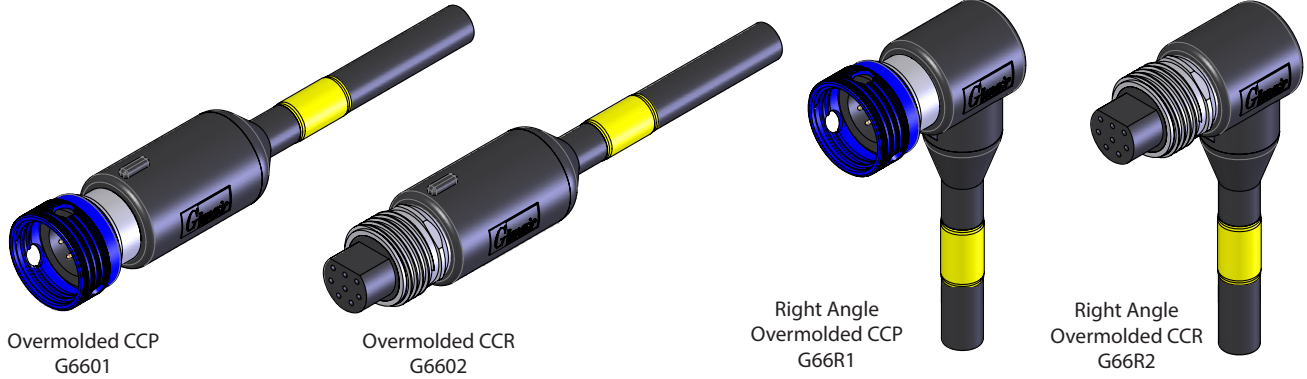

G66 OIL-FILLED CABLE CONNECTOR PLUGS AND RECEPTACLES

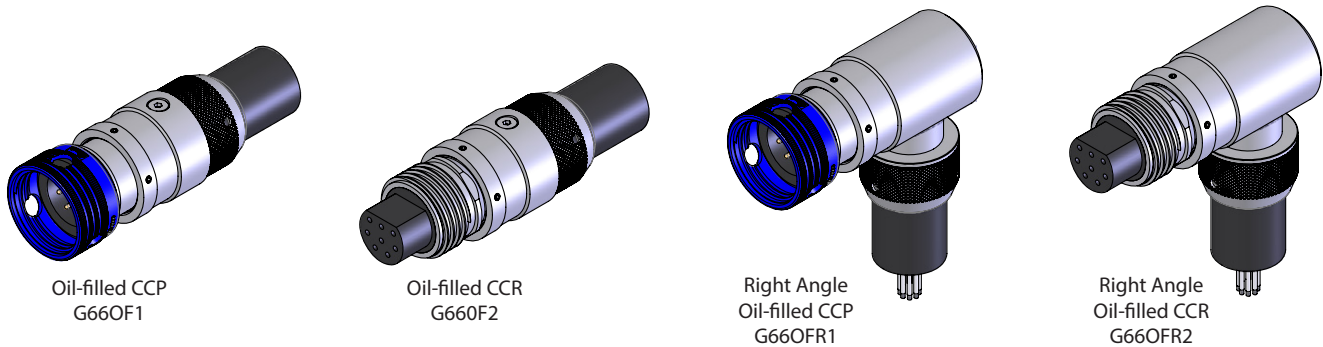

G66 CABLE CONNECTOR PLUGS AND BULKHEAD, FLANGE AND CABLE CONNECTOR RECEPTACLES

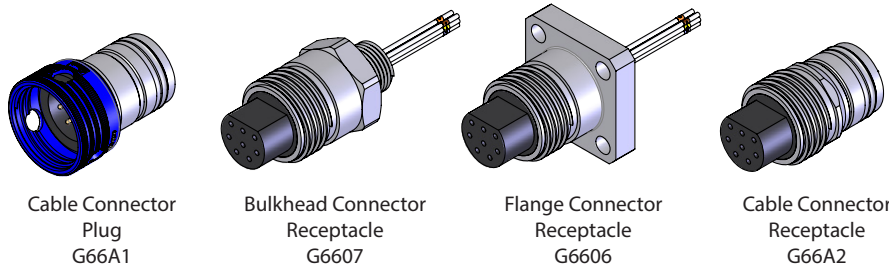

DUMMY SEALING PLUG AND RECEPTACLE

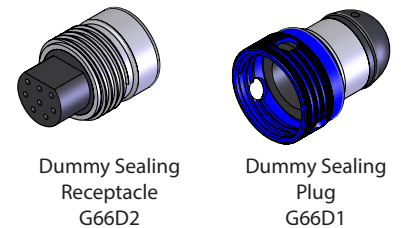

COMING SOON: SuperG66™ - Consult factory for availability				
Sample Part Number	G66A1	-2008	-0000	
Series	SuperG66™ = underwater dry-mate, cable connector plug (CCP)			
Shell Size/Insert Arrangement	See shell size / insert arrangements (page 48)			
Cable Length	0000 = no cable; also available in specified lengths for test purposes			
Material Option	Omit for stainless steel PK = peek coupling nut and barrel B = brass coupling nut and barrel Reference material options on page 47			
Potting Boot	PB = potting boot; omit if not required. Not required if changed to OFR1			

INSERT ARRANGEMENTS

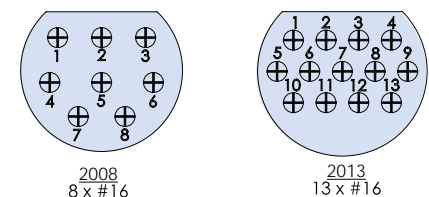

Additional insert arrangements can be engineered, contact factory

Series 707 Micro-PSI affords PIG designers the opportunity to design out legacy large form-factor connectors with a dramatically smaller high-speed interconnect solution.

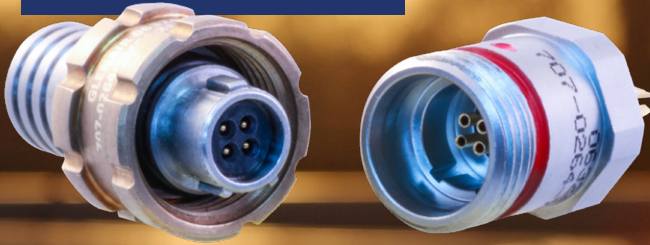

10K PSI SOLUTION

Micro-PSI

Microminiature high-speed, high-pressure connectors

The Series 707 Micro-PSI is a micro miniature 10K PSI high-pressure, high-temperature interconnect designed specifically for pipeline inspection applications in Magnetic Flux Leakage and ultrasonic pipeline inspection PIGs. The Micro-PSI insert arrangements feature high-density micro TwistPin layouts for sensor applications and high-speed Gigabit Ethernet, and a Coax contact layout for 3 GHz performance. Micro-PSI connectors are supplied as discrete plugs, or overmolded plug cordsets with rugged Viton or Polyurethane jacketing. Bulkhead and flange mount receptacles are 10K PSI open-face pressure sealed, and incorporate fused vitreous glass inserts for $<1 \times 10^{-7}$ scc He/sec hermetic performance. Serviceable O-rings on plugs and face O-rings on receptacles provide high-reliability sealing.

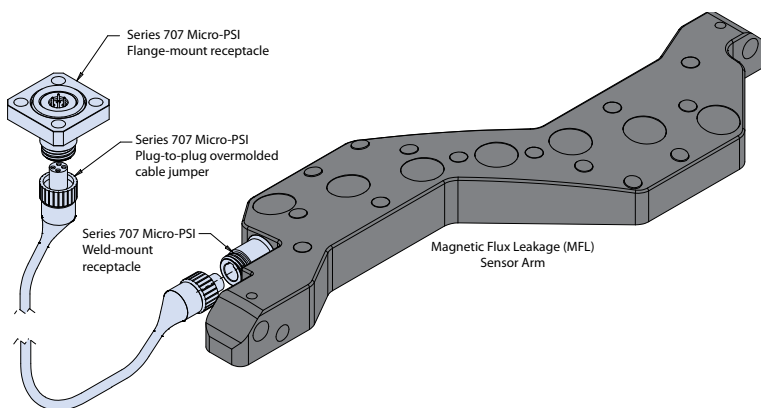

Application example shows the 707 Micro-PSI used to interconnect an MFL sensor to on-board PIG data storage.



- 10,000 PSI pressure rated
- 3 GHz Coax
- Less than 1×10^{-7} scc He/sec @ 1 ATM pressure differential
- Special-purpose high density (.056" contact spacing) intelligent inspection (PIG) connector series
- 2 Amp high-speed Gigabit Ethernet-ready
- -20° to +150°C temperature range
- High-density, small form-factor



10K PSI SOLUTION

Micro-PSI High-Speed, High Pressure I/I Connector



Specifications and insert arrangements

MICRO PSI HOW TO ORDER, SPECIFICATIONS, MATERIALS AND FINISHES

Micro-PSI - How To Order	
Sample Part Number	707-0264 -7 ME4 Z1 S N
Series / Basic P/N	707-0264 = Series and Basic Part Number
Connector Style	1 = CCP (Cable Connector Plug) 5 = CCR (Cable Connector Receptacle) 6 = FCR (Flange Mount Receptacle) 7 = BCR (Bulkhead Mount Receptacle)
Shell Size / Layout	ME1, ME4, ME6, MG10, MK19 (See Insert Arrangements diagram)
Shell Material	Z1 = Stainless Steel
Contact Type and Termination Style	Plugs P = Pin / Solder Cups Receptacles S = Socket / Solder Cups C = Pin / PCB Terminals D = Socket / PCB Terminals
Locking Position	N = Normal, A, B, C (See Key and Keyway Positions table below)

Performance Ratings

Connector Pressure Ratings:
10,000 PSI (Open face receptacle)
10,000 PSI (Mated CCP)

Pressure Tested To:
10,000 PSI per ISO 13628-6

Electrical Performance:
Insulation Resistance: 1000 Megohms
at 500 VDC per EIA-364-21
Coax Performance: DC to 3 GHz
Temperature Range: -20°C to +150°C

Hermeticity:
<1 x 10⁻⁷ scc He/sec @ 1 ATM pressure
differential; receptacles only

Connector Material / Finish

Connector Shell: 316L SST / passivated
Coupling Ring: nickel bronze / None
O-rings: Viton 90 durometer / none
Contacts: nickel-iron alloy / gold over nickel
Hermetic Seal: vitreous glass / none

NOTES

- Plug connectors typically supplied as prewired factory cable assemblies with Viton® overmolding for caustic chemical resistance
- Receptacle connectors commonly supplied as prewired pigtails or flex jumpers for direct connection to printed circuit boards and / or data drives
- High-speed Ethernet up to 1Gbps

MicroPSI Key and Keyway Positions				
Key Position	Key Rotation		Plug	Receptacle
	X°	Y°		
Normal (N)	150°	210°		
A	75°	210°		
B	95°	230°		
C	140°	275°		

INSERT ARRANGEMENTS

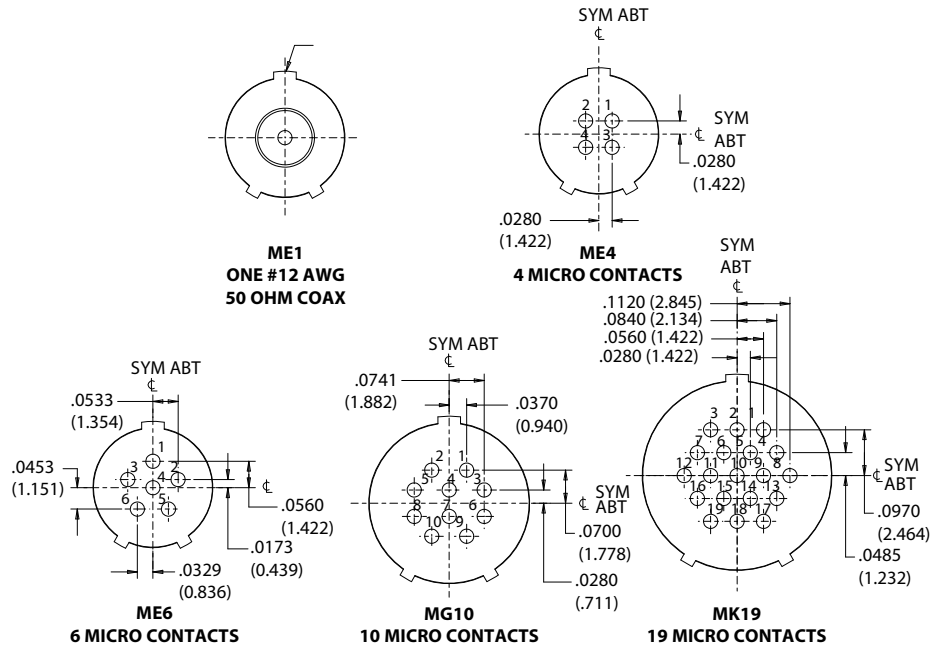



10K PSI SOLUTION Micro-PSI High-Speed, High Pressure I/L Connector Cable plugs and receptacles



707-0264-1 MICRO-PSI CABLE CONNECTOR PLUG

- 10K PSI rated, mated condition
- Red alignment indicator for accurate mating
- Serviceable O-ring for reliable sealing and easy maintenance
- Ultra small form-factor
- Mates with 707-0264-5 CCR, 707-0264-6 FCR and 707-0264-7 BCR

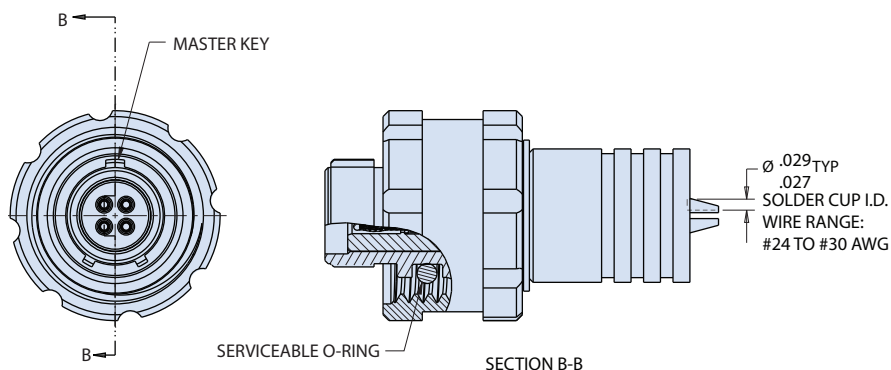
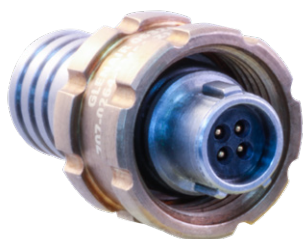
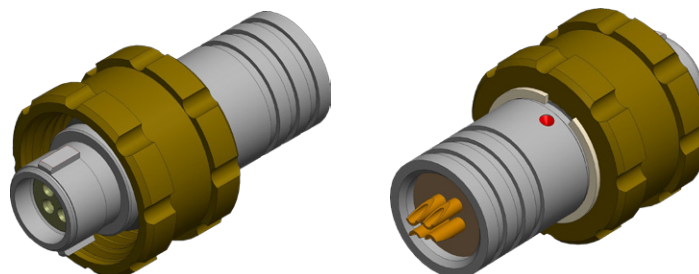

707-0264-5 MICRO-PSI CABLE CONNECTOR RECEPTACLE

- 10K PSI open-face rated
- Glass-to-metal sealed, $<1 \times 10^{-7}$ scc He/sec hermeticity
- Operating temperature -20° to $+150^{\circ}$ C
- Alignment and full-mate indicators
- Ultra small form-factor
- Flying lead option available
- Mates with 707-0264-1 CCP Plugs

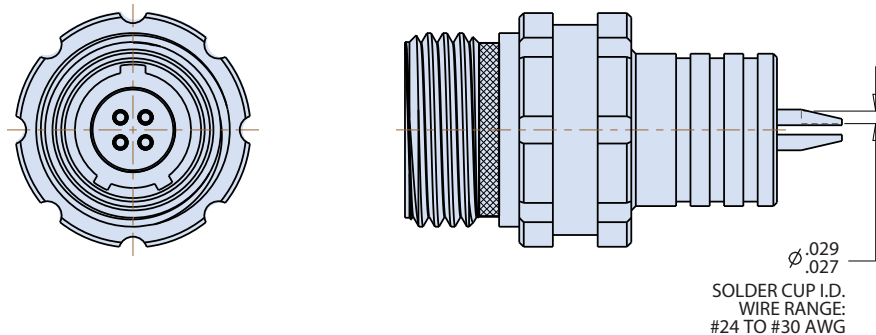
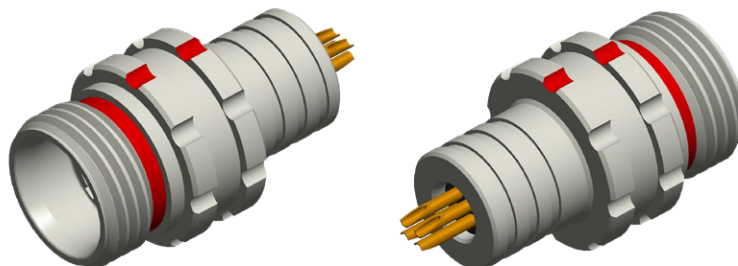



10K PSI SOLUTION Micro-PSI High-Speed, High Pressure I/I Connector Receptacles



707-0264-6 MICRO-PSI FLANGE MOUNT RECEPTACLE

- 10K PSI open-face rated
- Glass-to-metal sealed, $<1 \times 10^{-7}$ scc He/sec hermeticity
- Operating temperature -20° to $+150^{\circ}$ C
- Alignment and full-mate indicators
- Ultra small form-factor
- Flying lead option available
- Mates with 707-0264-1 CCP Plugs

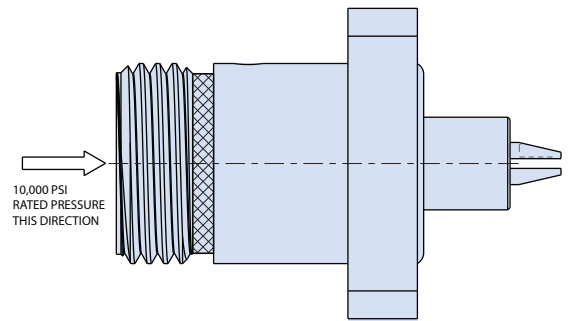
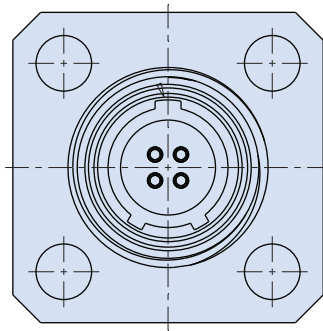
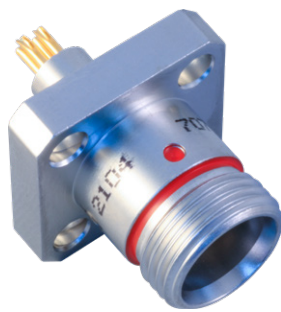
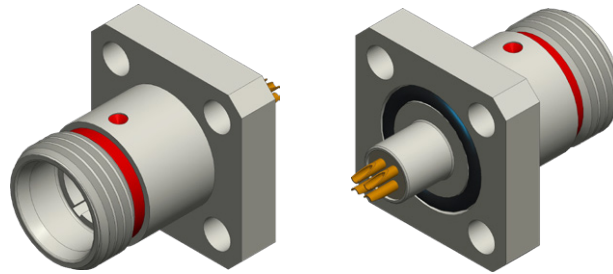

707-0264-7 MICRO-PSI BULKHEAD MOUNT RECEPTACLE

- 10K PSI open-face rated
- Glass-to-metal sealed, $<1 \times 10^{-7}$ scc He/sec hermeticity
- Operating temperature -20° to $+150^{\circ}$ C
- Alignment and full-mate indicators
- Flying lead option available
- Mates with 707-0264-1 CCP Plugs

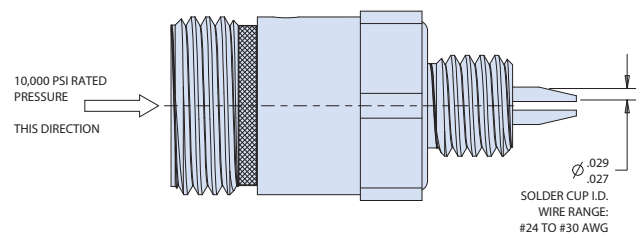
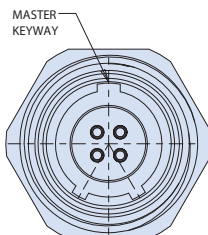
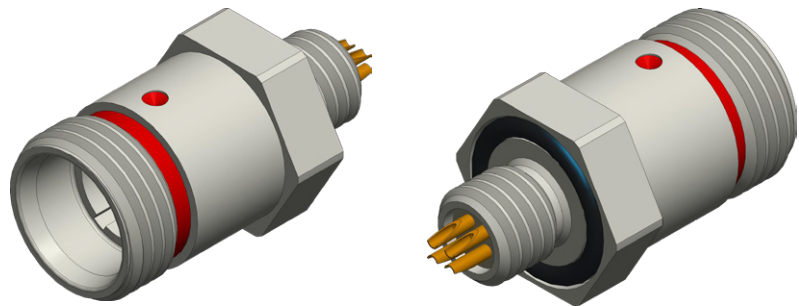



10K PSI SOLUTION Micro-PSI High-Speed, High Pressure ILI Connector



Overmolded and pigtail cable assemblies

7071-0069 MICRO-PSI OVERMOLDED PLUG-TO-PLUG / PIGTAIL CABLE ASSEMBLY

Micro-PSI - How To Order								
Sample Part Number	7071-0069	-S	R	-ME4	-Z1	U	N	-4
Series / Basic P/N	7071-0069 = Back-to-Back or Pigtail Plug Cable Assembly							
Overmold Style (P1)	R = Right Angle S = Straight							
Overmold Style (P2)	R = Right Angle S = Straight N = None (pigtail assembly)							
Shell Size / Contact Layout	ME1, ME4, ME6, MG10, MK19 (See Insert Arrangements diagram pg. 57)							
Plug Shell Material	Z1 = Stainless Steel							
Overmold and Jacket Mtrl	V = Viton U = Polyurethane							
Clocking Position	N = Normal, A, B, C (See page 59)							
Length (inches)	Length in inches, i.e. 4 equals 4 inches							

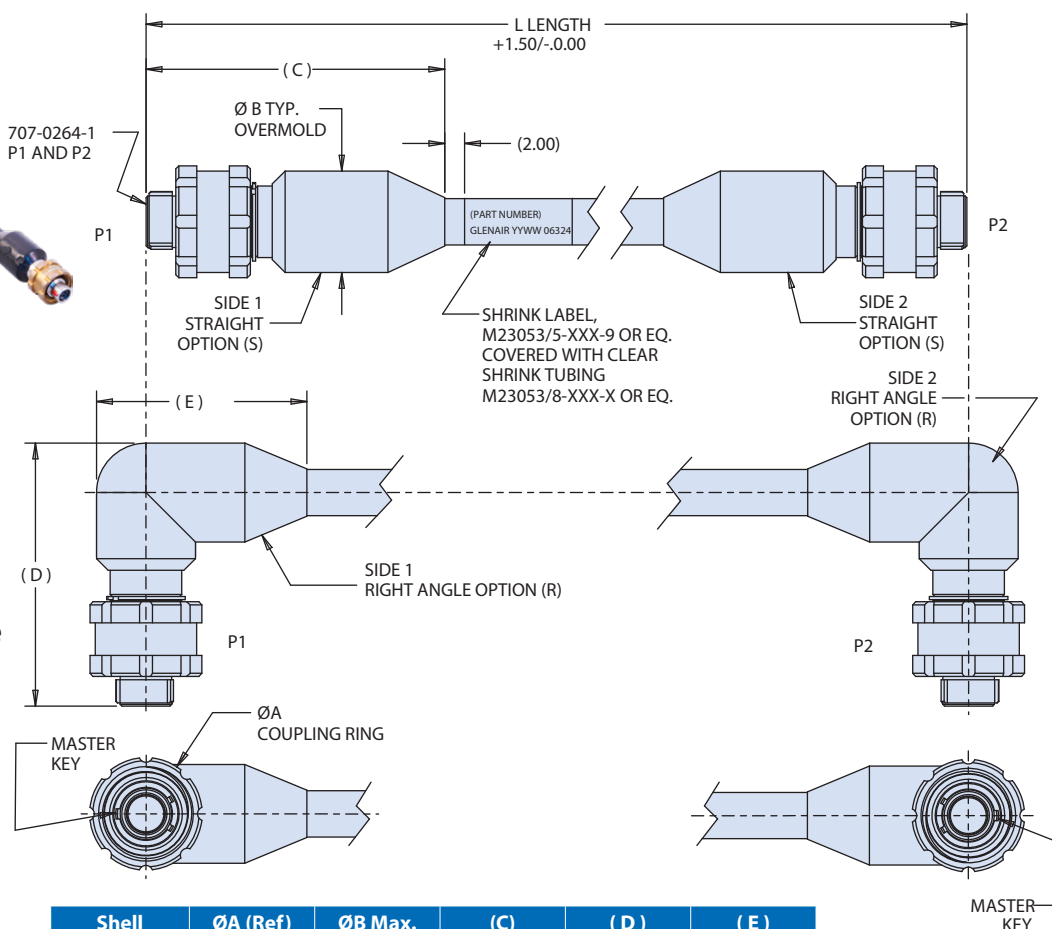
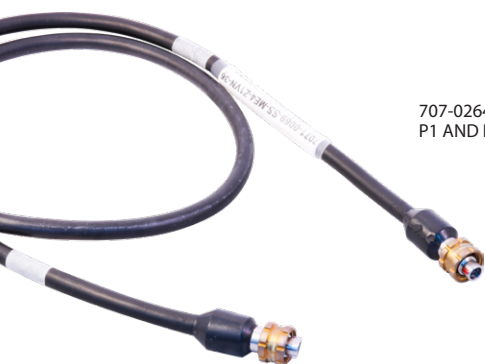

- Connectors and overmold assembly pressure-rated to 10K PSI
- 100% electrical test for shorts, DWV at 750 VAC and insulation resistance IAW MIL-STD-202

Shell Size	ØA (Ref) Cplg Ring	ØB Max. Overmold	(C) Overmold	(D) Overmold	(E) 90° Length
ME1 (Coax)	.550	.545	1.50	1.50	1.00
ME4 and ME6			2.25	1.50	1.60
MG	.675	.675	2.25	1.50	1.60
MK	.750	.750	2.25	1.65	1.80



10K PSI SOLUTION Micro-PSI High-Speed, High Pressure ILI Connector



Flying-lead pigtail assemblies/protective covers

7071-0572 MICRO-PSI FLYING-LEAD PIGTAIL ASSEMBLY

Micro-PSI - How To Order	
Sample Part Number	7071-0572 7 -ME4 -Z1 S N -16
Series / Basic P/N	7071-0572 = Flying-Lead Pigtail Cable Assembly
Connector Style	1 = CCP 5 = CCR 6 = FCR 7 = BCR
Shell Size / Contact Layout	ME1, ME4, ME6, MG10, MK19 (See Insert Arrangements diagram pg. 57)
Plug Shell Material	Z1 = Stainless Steel
Contact and Termination Style	S = Socket Contacts (for receptacles) P = Pin Contacts (for plug)
Clocking Position	N = Normal
Flying Lead Length (inches)	Length in inches (tolerance ± 1.00 inches. Minimum 4 inches.)

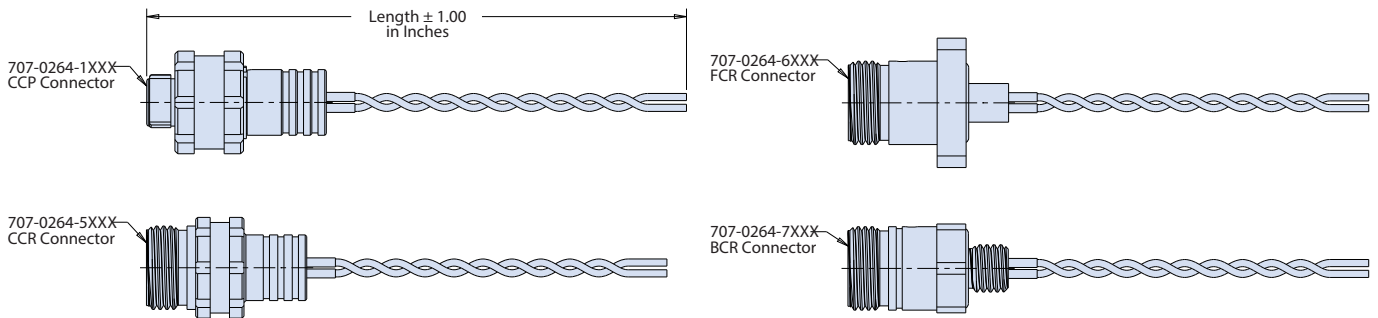

- Plugs rated 10K PSI mated condition
- Receptacles rated 10K PSI open-face and mated
- 100% electrical test for shorts, DWV at 750 VAC and insulation resistance IAW MIL-STD-202

709-100 MICRO-PSI PRESSURE-RATED PROTECTIVE COVERS: 709-101 PLUG / 709-100 RECEPTACLE

- 10K PSI rated, mated condition
- Red alignment indicator on receptacle cover for accurate mating, full-mate indicator on plug cover
- Serviceable O-ring on receptacle cover for reliable sealing and easy maintenance

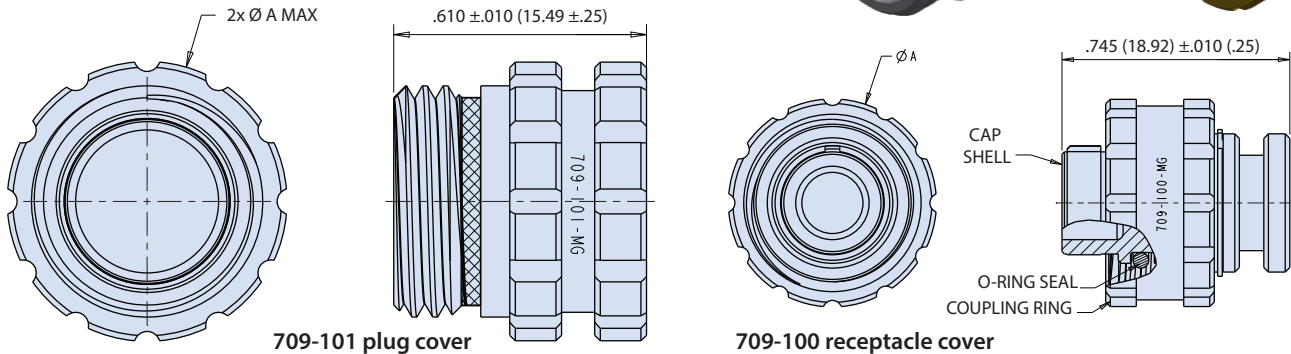
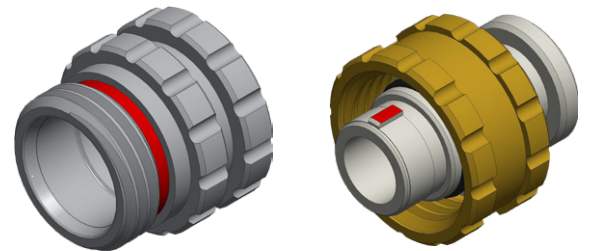



**SHALLOW
WATER**



Photo: SASOL

HIGH-DENSITY AquaMouse

Small form-factor 3500 PSI

Originally developed for petroleum pipeline inspection equipment, Series 802 connectors are available in ten sizes from 1 to 130 contacts and equipped with Viton® O-rings to withstand exposure to corrosive chemicals and high temperature environments. These connectors feature high density crimp Mighty Mouse inserts, 316 stainless steel or marine bronze shells and a piston O-ring for hydrostatic sealing. Series 802 insulated wire, panel mount receptacles can be ordered as square flange, in-line or jam-nut versions. Choose integral shield termination platform or accessory thread for use with a variety of strain relief options. Crimp style gold-plated crimp contacts accept #12–30 wire. Connectors are backfilled with epoxy potting compound. Hermetic glass-sealed connectors come with solder cup contacts (non-removable) or PC tails. 100% tested to meet 1 x 10⁻⁷ cc/sec helium leakage. Open face pressure rating 3500 PSI.

- 3500 PSI pressure rated
- High-temperature and corrosive chemical-resistant Viton® or Nitrile O-rings
- Ultraminiature #23 contacts
- Size #20, #20HD, #16, #12, #8 signal, power, fiber optic and shielded contacts
- Discrete connectors and turnkey cable assemblies

AQUAMOUSE CONNECTOR CONFIGURATIONS AND CLASSES



Series 802 Plugs



Series 802
Jam Nut Mount



Series 802
Square Flange Receptacle



Series 802
Hermetic



Series 802 Hermetic
Bulkhead Feed-Thru



HIGH-DENSITY 2400M / 3500 PSI Small Form-Factor Submersible



Series 802 AquaMouse™ performance specifications and material and finish

Glenair Series 802 AquaMouse™ Delivers High-Pressure Sealing and Rugged Design in a Miniature Package

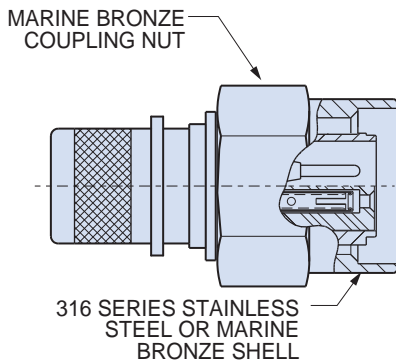

Series 802 Plug

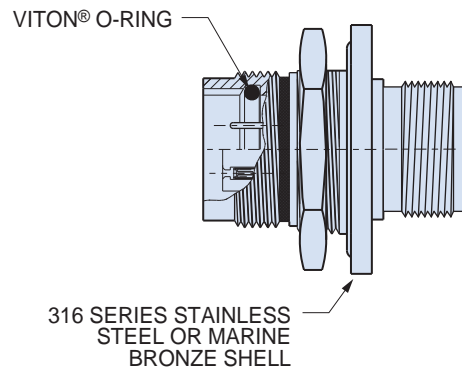

Series 802 Receptacle

Stainless Steel or Marine Bronze

Available in ten sizes from 1 to 130 contacts, Series 802 connectors feature 316 stainless steel or marine bronze shells. Viton® o-rings resist high temperature and corrosive chemicals.

3500 PSI

These connectors withstand up to 3500 PSI hydrostatic pressure in a mated condition. Hermetic versions withstand 1000 PSI open face pressure.

AQUAMOUSE SPECIFICATIONS AND PLUG KEY POSITIONS

Series 802 Plug Key Positions

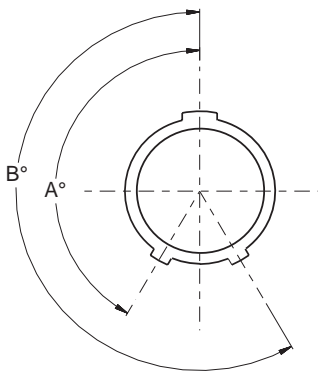

Key Position	Key Rotation	
	A°	B°
Normal (A)	150°	210°
B	75°	210°
C	95°	230°
D	140°	275°
E	75°	275°
F	9°	210°

Performance Specifications

Current Rating	#23–5 A, #20–7.5 A, #16–13 A, #12–23 A
Dielectric Withstanding Voltage	#23–750 VAC, #20HD–1000VAC, #16 and #12–1800 VAC
Insulation Resistance	5000 megohms minimum
Operating Temperature	-65° C. to +175° C.
Hydrostatic Pressure	3500 PSI mated, 1000 PSI open face (hermetic)
Shock	300 g.
Vibration	37 g.
Durability	2000 mating cycles

Material and Finish

Shells, Jam Nuts	316 stainless steel or marine bronze
Coupling Nuts	Marine bronze, unplated
Contacts	Copper alloy, 50 µlnch gold plated. Socket hood: stainless steel, passivated. Hermetic pin contacts: Nickel-Iron alloy per ASTM-F-30, 50 µlnch gold plated.
Insulators	Liquid crystal polymer (LCP) , 30% glass-filled
Contact Retention Clip	Beryllium copper alloy
Interfacial Seal, O-rings	Viton Rubber
Interfacial seal, rear grommet	Fluorosilicone rubber, blue
O-rings	Viton®



**SHALLOW
WATER**



5000 PSI PRESSURE-RATED Geo-Marine®

High-pressure harsh-environment connectors and overmolded cables for inline inspection pigs and shallow subsea applications

Designed for use in oceanographic, geophysical and other severe industrial environments, Glenair Series 22 Geo-Marine® Connectors and Cables are the ultimate harsh-environment power and signal connector solution. Built to withstand hydrostatic pressures up to 5,000 PSI and exposure to extreme temperatures and corrosives, the Series 22 Geo-Marine® is ideally suited for applications such as intelligent pipeline inspection, towed array sonar systems, submersibles and ROVs, offshore oil drilling equipment, seabed exploration, well monitoring equipment, and digital seismic streamers.

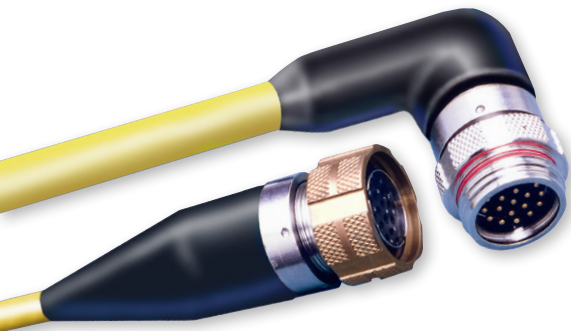

Geo-Marine® plugs are equipped with arctic coupling nuts—made from marine-grade naval bronze—with easy-to-grip castellated knurling and a powerful ratcheted anti-decoupling mechanism which guarantees reliable mating and demating performance in even the harshest environments. Supplied as discrete connectors—or more typically in build-to-print overmolded cable assemblies.



Geo-Marine®

- **5000 PSI pressure rated**
- **Marine Grade 316 stainless steel machined shells and Naval Bronze coupling rings**
- **High-pressure environmental and hermetically sealed receptacles for field applications**
- **Power and signal insert arrangements from 2 to 128 contacts**
- **Anti-vibration ratcheted coupling nuts with castellated knurling**
- **Available Viton® overmolded cable assemblies**



5000 PSI PRESSURE-RATED Geo-Marine® Connectors



High-pressure fused-glass underwater /
harsh-environmental connectors



Range of Offerings

Series 22 Geo-Marine® connectors are supplied with either fused-glass or high grade thermoplastic insulators. Both classes of connectors are supplied with rugged, corrosion-resistant materials. Low-profile and scoop-proof cable plugs and receptacles, as well as bulkhead feed-thrus are available. Specially-designed cable sealing backshells as well as EMI/RFI shield termination backshells and environmentally-sealed protective covers complete the range of discrete product offerings. 35 insert arrangements (contact sizes #12, #16, #20 and #22) are tooled and fully available. Special in-line single-pin HTHP glass fused contacts also available.

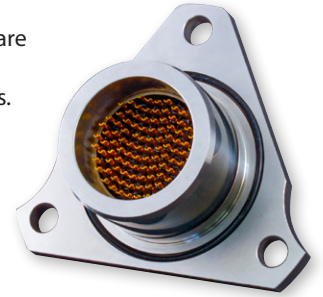

WIDE RANGE OF PLUG CONFIGURATIONS WITH ANTI-GALLING ARCTIC COUPLING NUTS



Cable plug with
accessory threads



Cable plug with
overmold adapter



Panel-mounted
plug

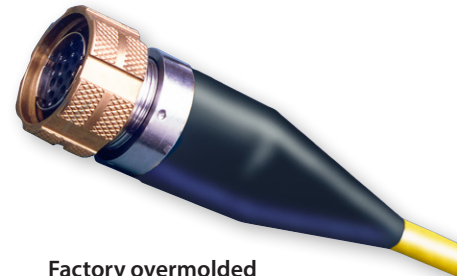

Factory overmolded
plug

HIGH-PRESSURE ENVIRONMENTAL AND FUSED-GLASS RECEPTACLE CONFIGURATIONS



Jam Nut



In-Line

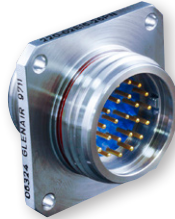

Square Flange



Solder-Mount



Bulkhead Feed-Thru



Single-pin HTHP

RUGGEDIZED STAINLESS STEEL BACKSHELLS AND OTHER CONNECTOR ACCESSORIES



Environmental strain
relief backshell



Overmolding
adapter



Right-angle
strain relief backshell



Environmentally sealed
protective covers



5000 PSI PRESSURE-RATED Geo-Marine® Connectors



High-pressure fused-glass underwater /
harsh-environmental connectors

Performance Specifications			
Hydrostatic Pressure Rating:	5,000 PSI (fully mated)		
Operating Temperature:	-65°C to +125°C		
Durability:	500 Cycles of mate/demate		
Insulation Resistance:	1000 Megohms minimum at 500 VDC		
Class H Hermetic Receptacles			
Open-Face Pressure Rating	1,000 to 5,000 PSI		
Hermeticity	Less than 1×10^{-6} sccHe/second @ 1 atmosphere		
Current Rating			
Current Rating	Environmental	Hermetic	
Size 22 Contact	500 VDC, 5 amps	500 VDC, 3 amps	
Size 20 Contact	500 VDC, 7.5 amps	500 VDC, 5 amps	
Size 16 Contact	750 VDC, 13 amps	750 VDC, 10 amps	
Size 12 Contact	750 VDC, 23 amps	750 VDC, 17 amps	
Service Rating			
Contact Size	Suggested Operational Voltage (Sea Level)		Test Voltage (Sea Level)
	AC(RMS)	DC	
22 GA	400	550	1300 VDC
20 GA	600	850	1800 VDC
16 GA	900	1250	2300 VDC
12 GA	300	450	2300 VDC

Depth/Pressure Conversion							
Feet	Meters	P.S.I.	Bar	Feet	Meters	P.S.I.	Bar
1	.3	.4	.0296	1,000	304.8	433.0	29.8543
10	3.1	4.3	.2965	1,500	457.2	649.5	44.7814
50	15.2	21.7	1.4962	2,500	762.0	1082.5	74.6357
100	30.5	43.3	2.9854	5,000	1524.0	2165.0	149.2715
250	76.2	108.3	7.4670	10,000	3048.0	4330.0	298.5430
500	152.4	216.5	14.9271	11,547	3519.35	5000.0	344.7379

Cable/Wire D.C. Resistance			
Copper Conductors at Room Temperature			
AWG	Ohms per 1000 feet	AWG	Ohms per 1000 feet
28	66.2 Max	20	10.4 Max
26	41.6 Max	18	6.5 Max
24	26.2 Max	16	4.1 Max
22	16.5 Max	14	2.6 Max
		12	1.6 Max

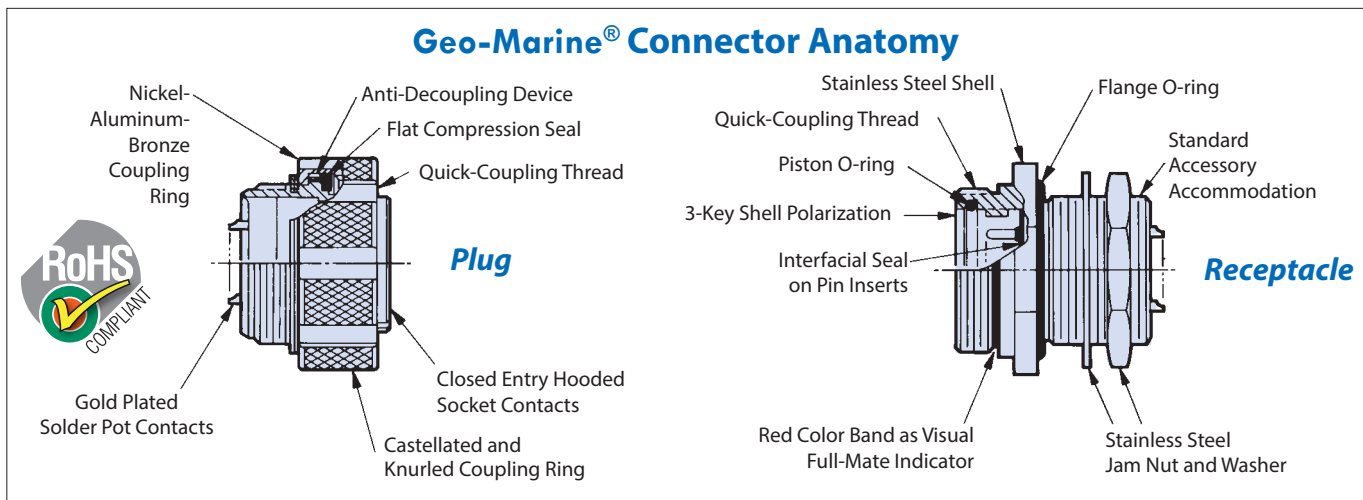



5000 PSI PRESSURE-RATED Geo-Marine® Connectors



High-pressure fused-glass underwater /
harsh-environmental connectors



Connector Materials and Potting		
Item	Material	Potting
Connector Shells	CRS 316 SAE-AMS-QQ-S-763	Stycast 2651/Catalyst 9
Protective Covers	CRS 316 SAE-AMS-QQ-S-763	
Solder Mount Receptacle	CRS 316 SAE-AMS-QQ-S-763	
Plug Coupling Nut	Marine Bronze SAE AMS-4640	
Molding Adapters and Backshells	See individual product pages	
Insulators, Class "E"	Epiall 1908, Diallyl Phthalate or Hysol CP2-4289	
Insulators, Class "H"	Fused Vitreous Glass	
Contacts, Pin - Class "E"	Leaded Nickel Copper, CA 7021	
Contacts, Pin - Class "H"	Nickel-Iron Alloy 52 - MIL-I-23011, Class 2	
Contacts, Socket	Copper Alloy, CA7021	
Contacts, Socket Hood	CRS, SAE-AMS-QQ-S-763 AISI 305	
O-Rings	Nitrile (Buna-N) Rubber MIL-G-21569	
Interfacial and Peripheral Seals	Flourosilicone Rubber MIL-DTL-25988	

Glenair can design and fabricate overmolded **Geo-Marine®** cable assemblies featuring **Viton®** chemical resistant materials—terminated and tested to deliver advanced levels of sealing and durability.



Caution
Electrical safety limits must be established by the user. Peak voltages, switching surges, transients, etc., should be used to determine the safety of application.

APPLICATION NOTES

- All parts will be identified with manufacturer's name and part number, space permitting.
- Glenair 600 series backshell assembly tools are recommended for assembly and installation.
- Electrical ratings are based on connectors only, not terminated to a cable or conductors, with proper cleaning and drying after hydrostatic testing.
- On all length callouts, tolerance is $\pm .060$ unless otherwise specified.
- Metric dimensions appear in parentheses in diagrams and tables, based on 1 inch = 25.4 mm, for reference only. Unless otherwise specified, the following other dimensional tolerances apply:
 $.xx = \pm .03$ (0.8)
 $.xxx = \pm .015$ (0.4)
 Lengths = $\pm .060$ (1.52)
 Angles = $\pm 5^\circ$

HIGH TEMPERATURE HIGH PRESSURE (HTHP) Glass Sealed Penetrators and Feedthroughs

Glass sealed penetrators and feedthroughs provide sealed interconnect solutions for downhole applications such as logging while drilling (LWD) and measurement while drilling (MWD) applying methods such as near-balanced, underbalanced and overbalanced drilling. In these environments, conditions can reach temperatures approaching 300°C while experiencing elevated shock and vibration, downhole fluids / pressures, and limited working room. Glenair HTHP penetrators are typically used where a waterproof seal is needed but connectorized separation from equipment is not. Standard plugs are rated to 10K PSI, mated condition. Standard receptacles are rated to 10K PSI both mated and open-face.

- Available in 7 shell sizes and 17 insert arrangements
- Standard penetrators with hermeticity of $<1 \times 10^{-7}$ sccHe/sec @ 1 atmosphere differential and rated to 10,000 PSI
- High-pressure / high-temperature penetrators rated to 25,000 PSI and hermeticity of $<1 \times 10^{-8}$ sccHe/sec @ 1 atmosphere differential

MULTI-PIN AND SINGLE-PIN PENETRATORS, RECEPTACLES, AND FEED-THRU

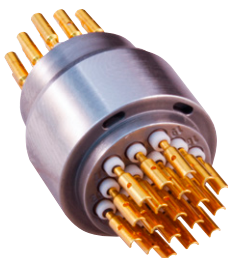

707-0015



707-0030

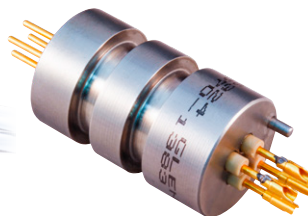

2570-1383



2570-1364

High Pressure/High Temperature Penetrators



Glass sealed insert contact arrangements - Mating face view of pin insert (socket insert IDs are reversed)

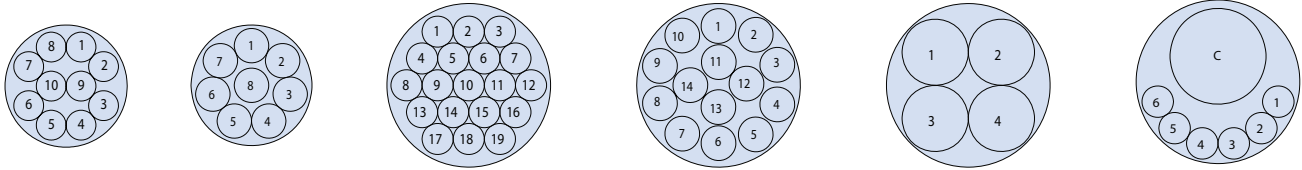

Size G		Size K			
G10	G8	K19	K14	K4	KC6
10 Size #22 Contacts	8 Size #20 Contacts	19 Size #22 Contacts	14 Size #20 Contacts	4 Size #16 Contacts	One 75 Ohm Coax, 6 #22

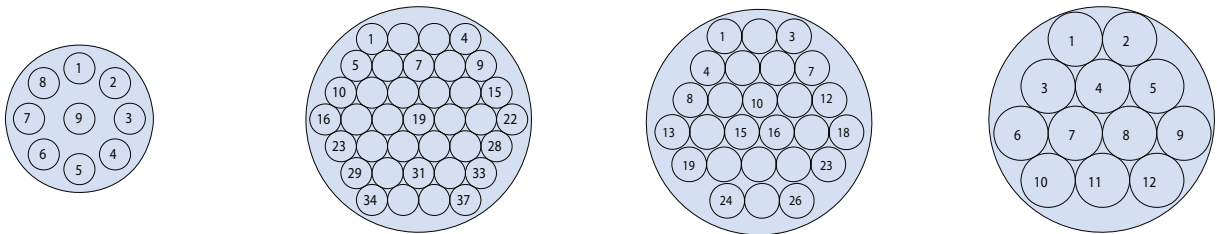

Size L	Size M		
L9	M37	M26	M12
9 Size #16 Contacts	37 Size #22 Contacts	26 Size #20 Contacts	12 Size #16 Contacts

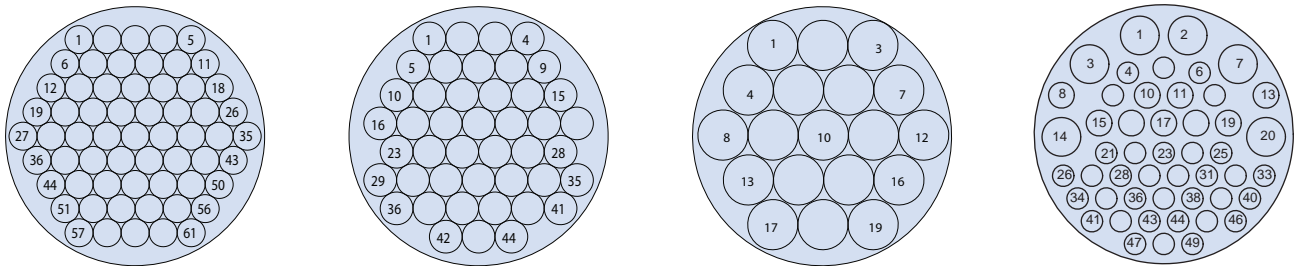

Size O			
O61	O44	O19	OX49
61 Size #22 Contacts	44 Size #20 Contacts	19 Size #16 Contacts	49 Contacts 6 #16 • 9 #20 • 34 #22

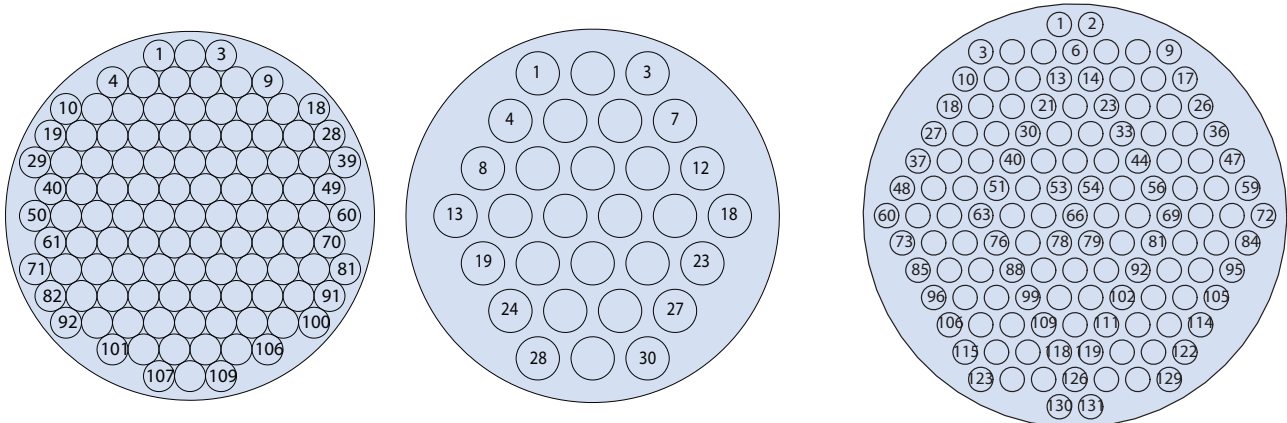

Size Q		Size R
Q109	Q30	R131
109 Size #22 Contacts	30 Size #16 Contacts	129 Size #22 Contacts

HIGH-TEMPERATURE

Well-Master[®] 260[°]

The Micro-D connector for serious, high-temperature applications

Standard Micro-D connectors are rated for +125°C. Glenair's MWDM Micro-D can withstand +150°C continuous operating temperature and can be upgraded to +200°C if assembled with special high temperature epoxies. But oil, gas and geothermal wells can subject electronic instruments to temperatures as high as +260°C. The GHTM Series Micro-D meets the need for a high density, high performance connector capable of handling this temperature. The GHTM features contacts made from a special alloy that resists softening when exposed to temperatures up to +260°C (500° F). Rugged passivated stainless steel shells and hardware, high temperature liquid crystal polymer (LCP) insulators allow these connectors to survive the most demanding environments. Unique angled mounting ears allow the Well-Master[™] 260[°] to fit in confined spaces.

- +260°C operating temperature
- Angled mounting ears to fit in small diameter instruments
- High reliability twistpin contact system with special high temperature alloy
- .050" Pitch contact spacing for reduced size
- Solder cup, pre-wired or PCB

Well-Master^{260°}[®]

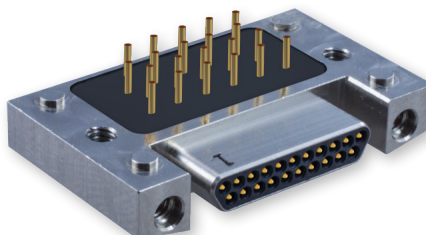

+260°C PCB Header



+260°C Cable Connector

In addition to extreme high temperature tolerance, and demating resistance to vibration and shock, the Glenair Well-Master™ 260° Micro-D connector features unique shell packaging designed to conform with the cylindrical shape of instrument housings. Special angled mounting ears facilitate incorporation of the connector into available space, and the Micro-D's overall reduced size compared to other rectangular connector solutions allows for more efficient utilization.

High Temperature Micro-D with insulated Wire Pigtails

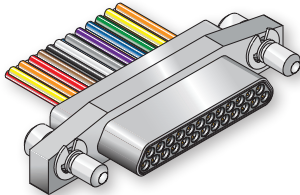

High Temperature PCB Header

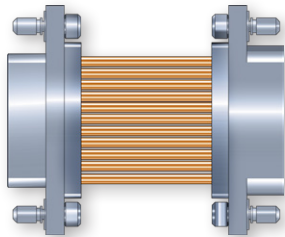
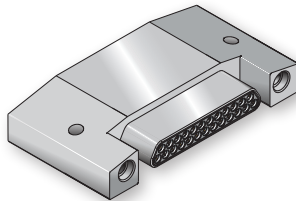

High Temperature Back-to-Back Micro-D

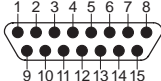
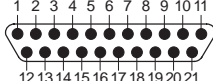
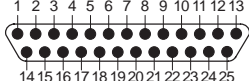
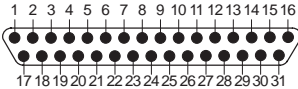
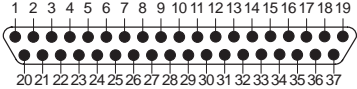
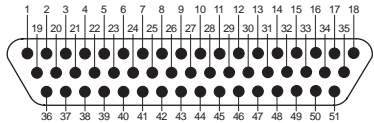

GHTM High Temperature Insert Arrangements (Pin Face View)

 <p>1 2 3 4 5 6 7 8 9</p>	 <p>1 2 3 4 5 6 7 8 9 10 11 12 13 14 15</p>	 <p>1 2 3 4 5 6 7 8 9 10 11 12 13 14 15 16 17 18 19 20 21</p>	 <p>1 2 3 4 5 6 7 8 9 10 11 12 13 14 15 16 17 18 19 20 21 22 23 24 25</p>
9	15	21	25
 <p>1 2 3 4 5 6 7 8 9 10 11 12 13 14 15 16 17 18 19 20 21 22 23 24 25 26 27 28 29 30 31</p>	 <p>1 2 3 4 5 6 7 8 9 10 11 12 13 14 15 16 17 18 19 20 21 22 23 24 25 26 27 28 29 30 31 32 33 34 35 36 37</p>	 <p>1 2 3 4 5 6 7 8 9 10 11 12 13 14 15 16 17 18 19 20 21 22 23 24 25 26 27 28 29 30 31 32 33 34 35 36 37 38 39 40 41 42 43 44 45 46 47 48 49 50 51</p>	
31	37	51	

Mating face of pin connector. Socket connector contact numbers are reversed.

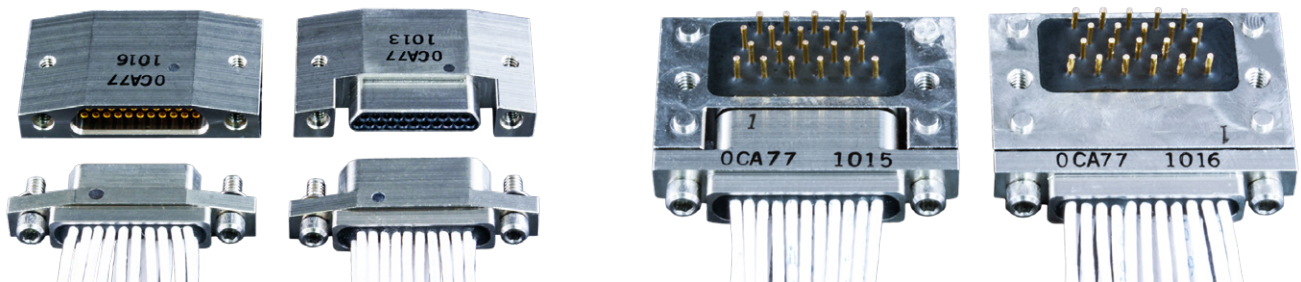



SERIES GHTM WELL-MASTER 260° Downhole Micro-D Connector



Insulated wire connector
with pin or socket contacts

GHTM PRE-WIRED CONNECTORS WITH +260°C MIL SPEC PTFE/POLYIMIDE WIRE

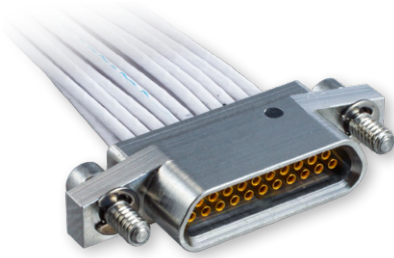

GHTM Well-Master™ 260° pre-wired Micro-D connectors withstand +260°C continuous operating temperature. These .050" pitch Micro-D connectors are terminated to #24 AWG insulated wire. Nickel-coated copper wire conforms to M22759/87, PTFE/polyimide insulation. Pin contacts are gold-plated high performance twistpin type and are recessed into insulator to prevent damage. Special nickel alloy contact material resists softening in high heat. Machined passivated stainless steel shell. Glass-filled high temperature LCP thermoplastic insulators. 100% hi-pot tested. Meets performance requirements of MIL-DTL-83513. Available with 9 to 51 contacts. 3 A., 600 Vac, -55°C to +260°C.

How To Order	
Sample Part Number	GHTM -31 S -4 T 1 -18 B
Series	GHTM Glenair High Temperature Micro
Shell Size	9, 15, 21, 25, 31, 37, 51
Contact Type	P - Pin/Plug S - Socket/Receptacle
Wire Gage (AWG)	4 - #24
Wire Type	T - PTFE/Polyimide Insulated Nickel Coated Copper
Wire Color	1 - White
Wire Length (Inches)	18 - Wire Length In Inches. "18" Specifies 18 Inches.
Mounting Hardware	B - Std. Thru-Hole (Ø.089/.095) M - Hex Head Jackscrew S - Slot Head Jackscrew P - Integral Jackpost See Mounting Hardware Table

GHTM Mounting Hardware		
B Std. Thru-Hole Mounting .096/.088 (2.43/2.23) Dia.	M and S #2-56 Jackscrews Slot head (S), Hex Head (M)	P Integral Jackpost #2-56
Pin	Pin	Pin
Socket	Socket	Socket



SERIES GHTM WELL-MASTER 260° Downhole Micro-D Connector



Back-to-back cable assemblies
and right-angle PCB headers

GHTM BACK-TO-BACK CONNECTORS WITH +260°C MIL SPEC PTFE/POLYIMIDE WIRE

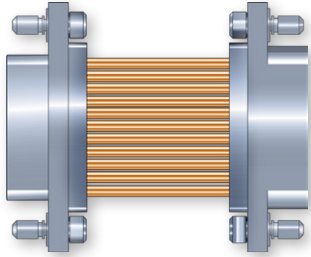

GHTM Well-Master® 260° back-to-back Micro-D cable assemblies withstand +260°C continuous operating temperature. These .050" pitch Micro-D connectors are terminated to #24 AWG insulated wire. Nickel-coated copper wire conforms to M22759/87, PTFE/polyimide insulation. Pin contacts are gold-plated high performance twistpin type and are recessed into insulator to prevent damage. Special nickel alloy contact material resists softening in high heat. Machined passivated stainless steel shell. Glass-filled high temperature LCP thermoplastic insulators. Meets performance requirements of MIL-DTL-83513. Available with 9 to 51 contacts. 3 A., 600 Vac, -55°C to +260°C.

How To Order	
Sample Part Number	GHTM -31 GS -6 T 1 -18 B
Series	GHTM Glenair High Temperature Micro-D
Shell Size	9, 15, 21, 25, 31, 37, 51
Contact Type	GP - Pin Connector Both Ends GS - Socket Connector Both Ends CS - Pin Connector to Socket Connector
Wire Gage (AWG)	4 - #24
Wire Type	T - PTFE/Polyimide Insulated Nickel Coated Copper
Wire Color	1 - White
Wire Length (Inches)	18 - Wire length in Inches (2" minimum for 2 rows, 3" minimum for 3 rows)
Mounting Hardware	B - Std. Thru-Hole M - Hex Head Jackscrew S - Slot Head Jackscrew P - Integral Jackpost (See Mounting Hardware Table, opposite page)

GHTM RIGHT ANGLE PRINTED CIRCUIT BOARD HEADERS



GHTM Well-Master® 260° right angle PCB Micro-D connectors withstand +260°C continuous operating temperature. These .050" pitch Micro-D connectors have .020 inch diameter (0.51mm) gold-plated PC terminals. Terminal spacing is .100 inch by .075 inch (2.54 by 1.91mm). Pin contacts are gold-plated high performance twistpin type and are recessed into insulator to prevent damage. Special nickel alloy contact material resists softening in high heat. Machined passivated stainless steel shell with integral jackpost. Glass-filled high temperature LCP thermoplastic insulators to withstand soldering heat. Meets performance requirements of MIL-DTL-83513. Available with 9 to 51 contacts. 3 A., 600 Vac, -55°C to +260°C.

How To Order	
Sample Part Number	GHTM -25 P RA P -110
Series	GHTM Glenair High Temperature Micro-D
Shell Size	9, 15, 21, 25, 31, 37, 51
Gender	P = Pin/Plug S = Socket/Receptacle
Termination Type	RA = Right Angle Board Mount
Mounting Hardware	P - Integral Jackpost; See Mounting Hardware Table opposite page
Terminal Length	All lengths ±.015 (.38) .080, .110, .125, .140, .150, .175, .190, .205

Hydrostatic Test Lab

GLENDALE, CALIFORNIA

Special behind-the-scenes tour of Glenair's hydrostatic test lab for high-pressure electrical and fiber optic interconnects



DISCRETE CONNECTOR TESTING: All Glenair high-pressure interconnects are subjected to 100% inspection and test

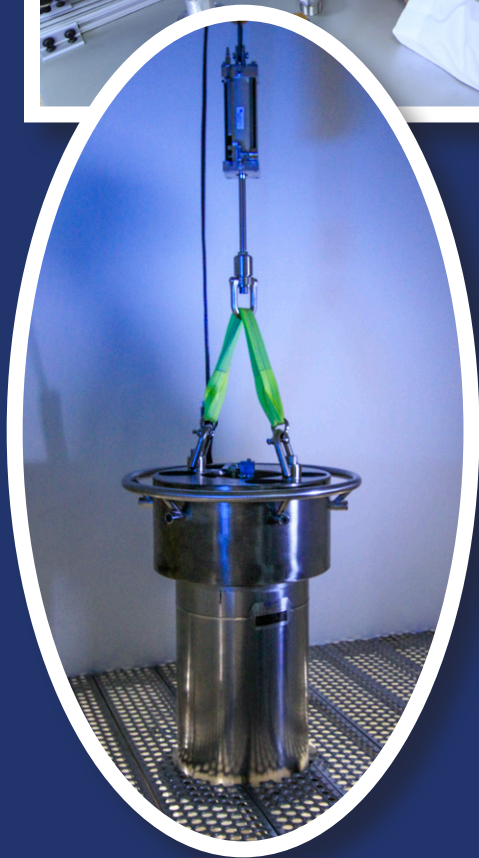

LARGE PRESSURE VESSELS: Built to accommodate complete cable assemblies, mated connectors, and customer-supplied subassemblies

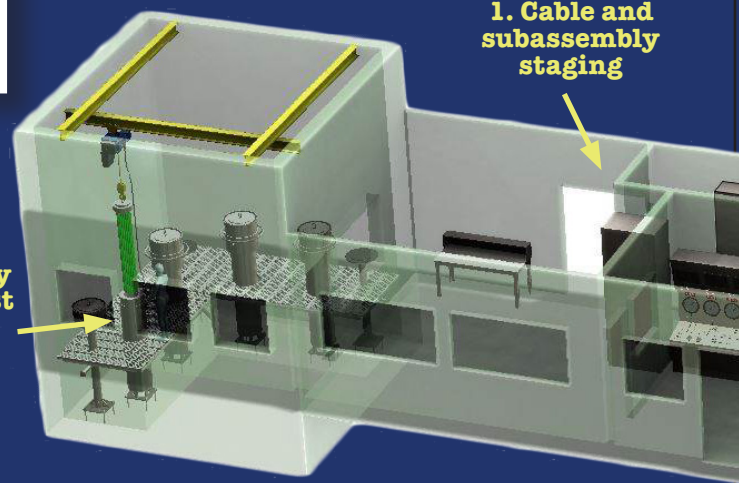

1. Cable and subassembly staging

2. Large cable and subassembly test bunker



TECHNICAL STAFF: Knowledgeable and trained subsea specialists perform both in-house product qualification testing, as well as customer subassemblies

CONTROL ROOM: The modular consoles in the control room provide for up to 8 pressure circuits, operating in Manual mode or Automated. Each circuit is capable of a maximum of 16.5K psi. Monitors display: Automated Test Profiles, Data Acquisition, remote viewing of Test rooms and more. System is network connected for access to Profiles and distribution of test reports.



3. Hydrostatic test lab control room

4. Production connector staging

5. Small connector pressure test bunker

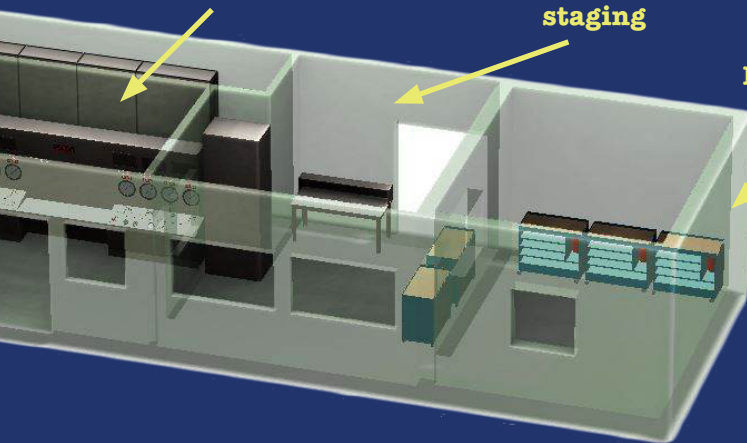

SeaKing™ and SuperG55™ QUALIFICATION TESTING: Both Glenair Series 70 SeaKing and SuperG55 rugged dry-mate subsea connectors have been tested and qualified to their 10K psi pressure rating—open-face and mated—in Glenair’s state-of-the-art hydrostatic test lab. Additional testing included mating cycles, salt spray, and electrical continuity.



Glenair Hydrostatic Test Lab Technical Specifications and Pressure Test Standards	
Pressure test profiles	Automated or manual
Maximum test pressure	16.5K psi
Data acquisition types	Pressure, time, temperature, and electrical performance
Performance monitoring under pressure	I/R, continuity, insertion loss, and backreflection (optical)
Industry profiles	All major oil & gas standards
Custom profiles	Yes, including customer-supplied subassemblies
Capacity (large pressure vessels)	Working volume = 12" diameter x 72" depth; Test specimen weight up to 1500 lbs.



MISSION-CRITICAL INTERCONNECT SOLUTIONS

Glenair, Inc.

1211 Air Way • Glendale, California • 91201-2497

Telephone: 818-247-6000 • Fax: 818-500-9912 • sales@glenair.com

www.glenair.com

Glenair East

20 Sterling Drive
Wallingford, CT
06492

Telephone:
203-741-1115
Facsimile:
203-741-0053
sales@glenair.com

Glenair UK Ltd

40 Lower Oakham Way
Oakham Business Park
Mansfield, Notts
NG18 5BY England

Telephone:
+44-1623-638100
Facsimile:
+44-1623-638111
sales@glenair.co.uk

Glenair Microway Systems

7000 North Lawndale Avenue
Lincolnwood, IL
60712

Telephone:
847-679-8833
Facsimile:
847-679-8849

Glenair Nordic AB

Gustav III : S Boulevard 42
SE-169 27 Solna
Sweden

Telephone:
+46-8-50550000
sales@glenair.se

Glenair GmbH

Schaberweg 28
61348 Bad Homburg
Germany

Telephone:
06172 / 68 16 0
Facsimile:
06172 / 68 16 90
info@glenair.de

Glenair Iberica

C/ La Vega, 16
45612 Velada
Spain

Telephone:
+34-925-89-29-88
Facsimile:
+34-925-89-29-87
sales@glenair.es

Glenair Italia S.p.A.

Via Del Lavoro, 7
40057 Quarto Inferiore –
Granarolo dell'Emilia
Bologna, Italy

Telephone:
+39-051-782811
Facsimile:
+39-051-782259
info@glenair.it

Glenair France SARL

7, Avenue Parmentier
Immeuble Central Parc #2
31200 Toulouse
France

Telephone:
+33-5-34-40-97-40
Facsimile:
+33-5-61-47-86-10
sales@glenair.fr

Glenair Korea

6-21TaPSII-ro 58beon-gil
Giheung-gu, Yongin-si
Gyeonggi-do
Republic of Korea

Telephone:
+82-07-5067-2437
Facsimile:
+82-504-375-4549
sales@glenair.kr