



Qwik Connect

GLENAIR ■ JANUARY 2014 ■ VOLUME 18 ■ NUMBER 1



INDUSTRIAL STRENGTH

INTERCONNECT SOLUTIONS *Glencair*





INNOVATION

Performance • Durability • Ease of Use



Geo-Marine®

Band-Master™ ATS

Well-Master 260°

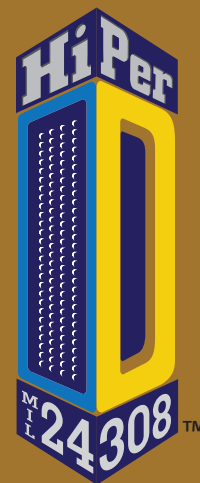

This special industrial-strength issue of QwikConnect provides a comprehensive overview of Glenair's "no gap" family of interconnect solutions for rugged industrial, rail, geophysical and power industry applications. No other interconnect manufacturer in the world offers such a broad range of connectors, backshells, wire protection conduit, shrink boots, tools and more for harsh-environment industrial applications. All our solutions are backed with our high availability customer service model, which includes in-stock availability on thousands of critical part numbers, no dollar or quantity minimum orders, free samples upon request, free engineering and application development and more. Contact the factory or our industrial/rail product team for more information.

	Series ITS Reverse-Bayonet Power and Signal Connectors	pg. 4
	Series IRT, ITS 901, ITS 500 and UJ High Current/High Voltage Connectors	pg. 6
	Series 970 PowerTrip™	pg. 8
	SuperSeal™ Ruggedized RJ45 and USB Ethernet Connectors	pg. 10
	Series 22 GeoMarine® Connectors	pg. 12
	UniPower™ Multi-Phase Power Connectors	pg. 14
	Octobyte™ High-Speed Quadrax Connectors	pg. 16
	Seacrow Marine Bronze Connectors	pg. 18
	RadGrip™ Easy-Mate Rubber Covered Coupling Nut Connectors	pg. 22
	Well-Master™ 260° Series GHTM High-Temperature Micro-D	pg. 24
	CostSaver Composite Junction Boxes	pg. 26
	Series 77 Full Nelson Environmental Shrink Boots	pg. 27
	EMI/RFI Braided Shielding, Ground Straps, and Earth Bond Tooling	pg. 28
	TurboFlex™ Ultra-Flexible Power Distribution Cable	pg. 30
	Duraelectric™ High-Performance Jacketing	pg. 31
	Series 72 Annular Polymer-Core Conduit	pg. 32
	Series 74 Helical Polymer-Core Conduit	pg. 33
	Series 75 Metal-Core Conduit	pg. 34
	Band-Master™ ATS Tools and Shield Termination Bands	pg. 36



SERIES ITS & DERIVATIVES

Circular industrial power and signal connectors for rugged applications— from mining equipment to monorails

- Dozens of proven connector technologies for harsh application environments
- Hundreds of power and signal contact arrangements (crimp and solder)
- Threaded, reverse bayonet, and innovative latch-and-lock coupling technologies
- Flame-resistant, caustic substance-free material choices for RoHS and other compliance standards



Circular Reverse-Bayonet and Threaded Coupling Connectors

- Series ITS** - Reverse-Bayonet Power and Signal
- Series ITS-RG** - RadGrip™ Rubber Coupling Nut Circular
- Series FRITS** - Flame-Resistant Insert for Rail Applications
- Series IT** - Threaded Coupling Power and Signal
- Series ITH** - Rigid Insert / Mechanical Contact Retention
- Series ITK** - High-Temperature Ceramic
- Series ITZ** - Triple-Start Thread Power and Signal
- Series IFO** - Reverse-Bayonet Fiber Optic
- Series IGE** - High Current, Low Voltage Single Pole
- Series 901** - High Current Medium Voltage Circular
- Series 500** - Reverse-Bayonet Single-Pole High Voltage
- Series IPT** - Standard Bayonet Power and Signal
- Series IPT-SE** - Standard Bayonet Crimp Contact



Glenair high-power tractor connector with TurboFlex™ cable, locking/lever coupling, and flexible standoff

INDUSTRY STANDARD AND GLENAIR INNOVATIONS Industrial/Rail Power and Signal Connectors



Circular Industrial/Rail Power and Signal Connectors: 5015 Type Derivatives



Series ITS
Reverse-Bayonet



Series ITH
Rigid Insert



Series IT
Threaded Coupling

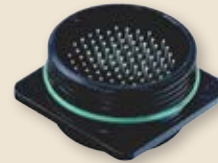

Series ITZ
Triple-Start Coupling



Series ITK
High-Temperature
Ceramic Insert



Seacrow
Marine Bronze



Series 901
Multi-Pin High Voltage



Series 500
Single-Pole High Voltage



Series IGE
Single-Pole Low Voltage



Series ITS Bayonet
with Wing Locks

High-Speed / Ruggedized Connectors for Industrial and Rail Applications



SuperSeal™
with RJ45 Ethernet



Series CX
High-Speed Coaxial



Octobyte™
Quadrax Contact Ethernet



Series IFO
High-Speed Fiber Optic

Series ITS-RG RadGrip™ Reinforced Rubber Coupling Nut Connectors



ITS-RG
(Basic Black)



ITS-RG
(Semper Tan)



ITS-RG
(Fiber Optic Blue)



ITS-RG
(Safety Red)



SERIES IRT • ITS 500 • ITS 901 • UJ

Rugged high current/high voltage power connectors for rail and industrial applications

Connection of power cables in rolling stock is a critical application. Beyond specific parameters like voltage, current, or watertight sealing, other application requirements must be considered: environment and operating conditions, robustness, handling, and other specifications.

The IRT connector series is one of the most popular connection systems used around the world, and is able to satisfy all of the common parameters from different railway authorities. Glenair is able to develop customized connectors for specific applications, certifying the products according to unique customer requirements.



Innovative tool-free locking and latching mechanisms

SERIES IRT RECTANGULAR MULTIPOLE HIGH VOLTAGE TRACTION MOTOR CONNECTORS



Plug Connector

Receptacle Connector

The Glenair IRT series is a rectangular power connector for harsh environmental conditions. Available with three, four and six contacts, typical for traction motor applications. Suitable for single cables AWG 4 – 373MCM (35 to 185 mmq). Working voltage up to 3000 Vcc.

Two mating systems offered:

- Screws, for light weight and reduced dimensions
- Lever system with secondary lock, easy to use in difficult positions.

The IRT Series is suitable for separated power cables, with or without screen, ground body available with a copper plait (not supplied with the connector).

Available with three different cable backend styles:

- Metallic Gland
- Clamp with Strain Relief
- Screen EMC Gland

IRT series connectors meet the most important rail requirements and specifications.

ITS 901 SERIES REVERSE BAYONET MULTI-POLE MEDIUM VOLTAGE JUMPER CONNECTORS



Plug Connector



Receptacle Connector

ITS 901 Series is the extension of the ITS Reverse Bayonet connector family, for power cables over AWG 1/0. Suitable for harsh environmental conditions, 901 Series Connectors accept cable from AWG 4 to 262 MCM (35 - 120 mmq), for current up to 450 Amp. Working voltage: 800 - 1000 Vac. Available for single wires and multipole jacketed cables, with cable clamp or conduit. Male contacts with Finger Test Protection, Load Side (Receptacle or Plug). Long bayonet ramps, three polarization keys and rubber recovered coupling facilitate mating and unmating operations.

901 Series meet the most important rail requirements and specifications:

- Salt Spray Test Corrosion: 500 hours;
- 500 Mating Cycles;
- Shock and Vibrations for Under-Car and Car-To-Car Applications;
- IP67 Sealing (Coupled Connectors);
- Fire Resistant and RoHS Compliant Materials.

ITS 500 SERIES REVERSE BAYONET SINGLE-POLE HIGH VOLTAGE JUMPER CONNECTORS



Plug Connector



Receptacle Connector

ITS 500 Series derives from an important Military Specification for Power Connectors: VG96929. Suitable for harsh environmental conditions, ITS 500 accepts cable gauges AWG 3/0 to 444MCM (95-240 mmq), for current up to 750 Amp. Special insulator drawing allows high working voltage, up to 3000 Vcc. Suitable for jacketed cables, with or without conduit protection. Receptacle with finger protection (Load side).

ITS 500 meets the most important rail requirements and specifications:

- 500 Mating Cycles;
- Salt Spray Test Corrosion: 500 hours;
- Shock and Vibrations for Under-Car and Car-To-Car Applications;
- IP67 Sealing (Coupled Connectors);
- Fire Resistant and RoHS Compliant Materials.

UJ SERIES POWER JOINT CONNECTOR SYSTEM



Offers the possibility to connect medium and high power cables without the need for bulky junction boxes. The UJ Power Joint System offers the same environmental protection with substantial size and weight savings.



	UJ Series	Junction Box
Dimensions	Small	Regular / Big
Weight	Light	Heavy
Protective Varnish	No	Yes
Modularity	Yes	No
Environmental	Yes	Yes
Electrical Performance	Yes	Yes
Cost Reduction	Yes	No
Temperature Range	High	Standard



SERIES 970

PowerTrip™

Reduced size and weight power connectors



Lightweight plug with ratcheting coupling nut and LouverBand contacts



Keyed receptacle with superior sealing and EMI shielding



- Fast, easy mating with triple-start ACME thread: 360° turn for full mating
- Reduced size and weight compared to 5015/VG95234 solutions
- LouverBand sockets for improved current ratings and longer life, up to 2000 mating cycles
- Splined backshell interface for improved backshell attachment and EMI shielding
- Ratcheting coupling nut for secure mating
- Operating temperature -65° C to +200° C

The Series 970 PowerTrip™ offers improved performance compared to standard 5015 type power connectors: higher density and lighter weight packaging, rapid mating and demating triple-start threaded coupling, and extremely rugged splined and threaded backshell attachment interface

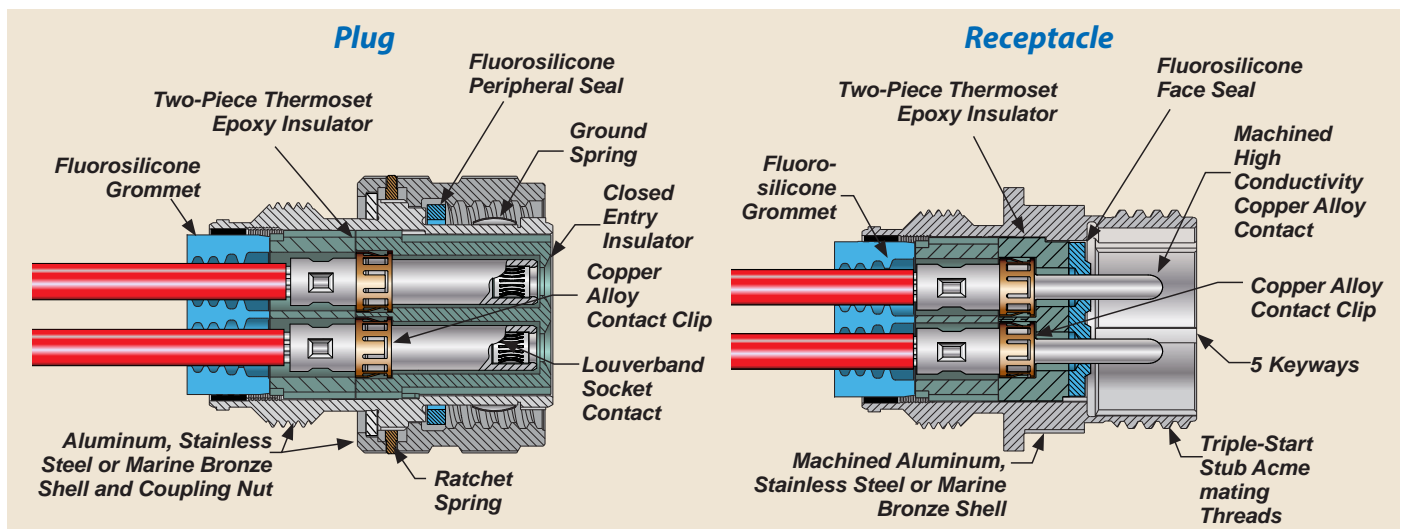

Series 970 PowerTrip™ Specifications	
Current Rating	Up to 225 A.
Dielectric Withstanding Voltage	2000 VAC
Insulation Resistance	5000 megohms minimum
Operating Temperature	-65° C. to +200° C.
Shock	300 g.
Vibration	37 g.
Shielding Effectiveness	65 dB minimum from 1GHz to 10GHz.
Durability	2000 mating cycles

CONTACT RESISTANCE AFTER 1000 MATING CYCLES

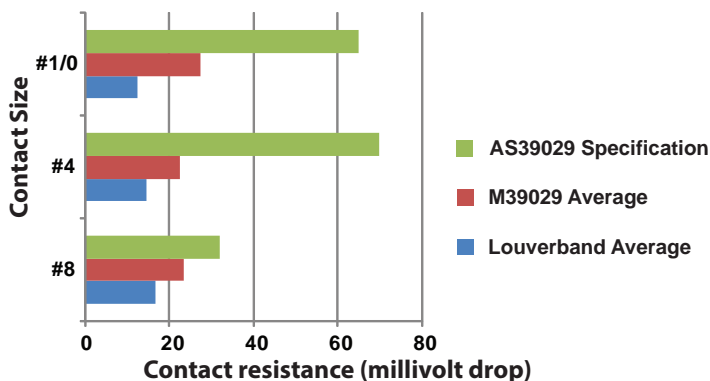

ABOUT THE POWERTRIP CONTACT SYSTEM

Series 970 contacts are precision-machined using high conductivity copper alloy. A stamped and formed spring ("louverband") is installed into the socket contact. The spring is made from 6 mil copper alloy. Testing has demonstrated that this contact system outperforms conventional aerospace-grade contact systems. The louverband spring provides many points of electrical contact with the mating pin, as opposed to a few "high spots" on a conventional four-finger contact as shown in the figure below. The size #8 Powertrip socket contact has a total of 18 louvers. The #4 has 27 louvers, and the #1/0 has 42 louvers. The louverband design offers lower voltage drop for reduced joule heating. In addition to its electrical advantages, the louverband also is mechanically superior to four-finger contacts. The louverband spring has consistent, stable normal force, even when subjected to thousands of mating cycles and temperature extremes.



Conventional contact on the left, LouverBand contact on the right

LouverBand socket contact cutaway



SUPERSEAL™

Ruggedized RJ45 and USB connectors for industrial/rail applications

Glenair offers the world's most comprehensive line of ruggedized RJ45 Ethernet and USB connectors in 5015 type connector packaging. The SuperSeal™ line offers superior sealing for complete protection against water, sand and dust in harsh environment applications; shielded/grounded coupler designs in both plug and receptacle connectors; and crimp, solder-cup, PC tail and Quadrax contact/wire termination options.



- Rear-release crimp contact termination and USB/RJ45 jumper accommodation
- Superior sealing, IP67 in unmated condition compared to other available environmental circulars
- Superior grounding for electrostatic discharge and EMC
- Superior cable shield termination with integrated banding platform
- Optional spring-loaded protective covers for environmental protection of junction boxes and switches
- Wide range of high speed Ethernet/network protocols supported, including USB 2.0, USB 3.0, and RJ45



Triple-start threaded connector with sealed RJ45



MIL-DTL-5015 with sealed RJ45



Wall-mount connector with USB jack and jumper



High-capacity, high-speed USB data stick

Product Selection Guide



SuperSeal™ 5015 Reverse Bayonet Plug with Cat 5e RJ45 Plug and Rear Crimp Contact Termination



SuperSeal™ 5015 Reverse Bayonet Plug with Cat 5e RJ45 Plug and Pre-Terminated Pigtail



SuperSeal™ 5015 Reverse Bayonet Receptacle with Cat 5e RJ45 Jack and Pre-Terminated Pigtail



SuperSeal™ 5015 Reverse Bayonet Receptacle with Cat 5e RJ45 Jack and PCB Termination



SuperSeal™ 5015 Reverse Bayonet Receptacles with Cat 5e RJ45 Jack/Jack Couplers



SuperSeal™ Reverse Bayonet RJ45 Connectors Cable Clamps, Cable Glands, and Backshells

PRODUCT SPECIFICATIONS

MATERIAL AND FINISHES:

Shell/coupling – High strength Aluminum alloy
 Plating – Electroless Nickel, Cad O.D., Black Zinc Cobalt or Std. black electrodeposited paint
 Bronze, stainless steel and other materials and finishes available. Please consult factory.

SHELL TYPE AND SIZES:

Shell Type – D5015 Reverse-Bayonet Type
 Sizes – Shell size 18

CONNECTOR STYLES:

Receptacle – MIL-DTL-5015 type in shell size 18 with integrated RJ45 jack/jack or jack/PCB coupler available in Cat 5e
 Plug – MIL-DTL-5015 type plug in shell size 18 with integrated RJ45 plug/jack coupler available in Cat 5e

Available in square flange front or rear wall mount with slotted or round holes, jam nut front or rear wall mount, in-line, and feedthrough configurations.

TECHNICAL CHARACTERISTICS:

Category – Cat 5e
 Connection – 10BASE-T, 100BASE-TX, 1000BASE-T
 Max Current Rating –1.5 Amps at 20° C
 Dielectrc Withstanding Voltage – 1000 volts
 Working Temperature – -40° to +85° C
 Environmental Rating – IP67 unmated

TERMINATION OPTIONS:

Crimp contact and PCB termination, pre-terminated pigtails; jack/jack and jack/plug RJ45 configurations



SERIES 22

Geo-Marine

High-pressure harsh-environment connectors and overmolded cables

Applications

Designed for use in oceanographic, geophysical and other severe industrial environments, Glenair Series 22 Geo-Marine® Connectors and Cables are the ultimate harsh-environment power and signal connector solution. Built to withstand hydrostatic pressures up to 5,000 PSI and exposure to extreme temperatures and corrosives, the Series 22 Geo-Marine® is ideally suited for applications such as US Navy towed array sonar systems, military land vehicles, submersibles and ROV's, offshore-oil drilling equipment, seabed exploration, pipeline inspection systems, well monitoring equipment, and digital seismic streamers.

Design

Geo-Marine® plugs are equipped with arctic coupling nuts—made from marine-grade naval bronze—with easy-to-grip castellated knurling and a powerful ratcheted anti-decoupling mechanism which guarantees reliable mating and demating performance in even the most harsh environments. Supplied as discrete connectors, or more typically in build-to-print overmolded cable assemblies, the Series 22 Geo-Marine® has demonstrated proven performance since the early 1970s. Today's Geo-Marine® represents over 40 years of innovation and refinement in supplying harsh-environmental interconnect solutions.



Geo-Marine®

- Marine Grade 316 stainless steel machined shells and Naval Bronze coupling rings
- High-pressure environmental and hermetically sealed receptacles for field applications
- Power and signal contact arrangements from 2 to 128 contacts
- Anti-vibration ratcheted coupling nuts with castellated knurling
- Available Viton® overmolded cable assemblies



High-pressure environmental and hermetic connectors



Range of Offerings

Series 22 Geo-Marine® connectors are supplied with either fused-glass (“H” hermetic class) or high grade thermoplastic (“E” environmental class) insulators. Both classes of connectors are supplied with rugged, corrosion-resistant materials. Low-profile and scoop-proof cable plugs and receptacles, as well as bulkhead feed-throughs are available. Specially-designed cable sealing backshells as well as EMI/RFI shield termination backshells and environmentally-sealed protective covers complete the range of discrete product offerings. 35 insert arrangements (contact sizes #12, #16, #20 and #22) are tooled and fully available.

Anti-Galling Arctic Coupling Nuts

One of the most valuable features of the Series 22 Geo-Marine® from the user’s perspective is the specially-designed castellated and knurled coupling nut which facilitates rapid mating and demating in field applications. Single-start, stub Acme threads reduce thread fouling and binding, and are supplied with an anti-vibration/anti-decoupling device which prevents accidental loosening or decoupling. Plugs contribute to high-pressure sealing, up to 5,000 PSI in the mated condition, by means of rugged and durable interfacial and peripheral seals.



Performance Characteristics			
Hydrostatic Pressure Rating		5000 psi (fully mated)	
Operating Temperature Range		-65°C to +150°C	
Durability		500 Cycles of mate/demate	
Class H Hermetic Receptacles			
Open-Face Pressure Rating		1000 to 5000 psi	
Hermeticity		Less than 1 X 10 ⁻⁶ cc Helium per second	
Current Rating	Environmental	Hermetic	
Contact Size 22	5 amps	3 amps	
Contact Size 20	7.5 amps	5 amps	
Contact Size 16	13 amps	10 amps	
Contact Size 12	23 amps	17 amps	
Service Rating	Suggested Operational Voltage (Sea Level)		Test Voltage (Sea Level)
	AC(RMS)	DC	
M	400	550	1300 VMRS
N	300	450	1000 VMRS
I	600	850	1800 VMRS
II	900	1250	2300 VMRS
Insulation Resistance		1000 Megohms minimum at 500 VDC	

Receptacle Configurations: High-pressure environmental (“E”) and hermetic (“H”) class receptacles are available for cable as well as box applications. Rugged o-ring piston seals located inside the receptacle barrel contribute to reliable high-pressure sealing in the mated condition. Glenair is able to supply Geo-Marine® customers with a wide range of receptacle configurations for unique requirements including low-profile and scoop-proof designs, pin and socket contact designs, solder cup and printed circuit board termination, unique flange shapes and mounting configurations, in-line cable receptacles, connector savers and gender changers.



UniPower™ Connectors

Safe, rugged, and reliable multi-phase power distribution connectors

Glenair UniPower™ Connectors provide reliable interconnection between power generation and distribution systems and high-powered equipment such as three-phase motors, concert sound systems, lighting panels, carnival rides and municipal emergency power systems. The color-coded plastic bodies are fire and high impact resistant and are also watertight when mated.

- For heavy industry, mobile generators, sound equipment, and entertainment industry power distribution applications
- Color-coded for three-phase application
- Easy termination and assembly
- Secondary locking mechanism and contacts with dielectric covers for added safety

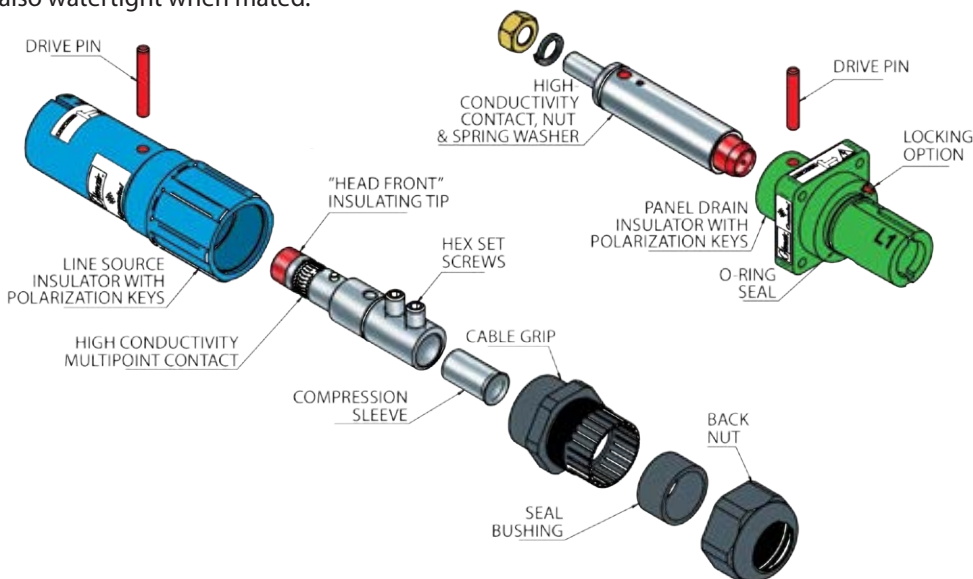

Safe, rugged and reliable multi-phase power distribution connectors

LINE SOURCE



Line Source
400A, Black

Line Source
800A, Brown

Glenair UniPower™ line source connectors are available in 400A and 800A ratings, and feature rigid male contacts with a dielectric cover to prevent accidental shock. A secondary locking pin slot ensures connector pairs will stay mated—free from accidental decoupling. Cable sealing glands protect against environmental damage to contact terminations. Finally, a rugged nylon cotter pin secures everything in place, for long-term, reliable power connectivity for even the most challenging of applications.

The 400A version allows users to terminate a wide range of cables, from 25mm² to 120mm², by means of a reduction sleeve. Simply tightening the two set screws atop the contact fastens the reducer onto the wire—providing complete versatility in the selection of cable and wire for power system applications.

LINE DRAIN



Line Drain
400A, Black

Line Drain
800A, Blue

Glenair UniPower™ line drain connectors are available in 400A and 800A max current ratings, and feature rigid IP2X spring loaded contacts secured firmly in place with rugged nylon cotter pins. Like their source counterparts, shock-resistant insulating tips safeguard users from accidental electrocution.

Standard O-ring and cable sealing glands ensure IP67 environmental rating when connectors are mated for long-term durability and reliability.

Tugged cables or curious hands can't accidentally decouple UniPower™ connector pairs, thanks to a secondary locking pin that securely joins the connectors in the mated position. A secondary remote locking key disengages the mated connectors safely and quickly. Color coded connectors prevent mis-mating and comply with EU, UK and US standards.

PANEL SOURCE AND DRAIN



Panel Source
400A, Black

Panel Drain
400A, Black

Glenair UniPower™ panel source and drain connectors offer complete flexibility in power system device configuration. Choose between source and drain formats, in either 400A or 800A ratings. All panel connectors feature a rigid IP2X 'finger proof' dielectric insulating tip to protect users from accidental electrocution.

The panel source connector features a male contact and secondary locking pin slot to prevent accidental cable de-mating due to cable torsion. Panel drain connectors are supplied standard with female contacts that feature an IP2X spring loaded nose and IP67 rated O-ring environmental seal. The connectors are ideally suited for industrial power distribution systems, three-phase motors, concert sound systems and other outdoor, environmental applications. All panel receptacles are shipped fully assembled. Color coding prevents mis-mating and ensures compliance with EU, UK and US standards.

Product Specifications

Formats: Panel Drain, Panel Source, Line Drain, and Line Source
Cable Section: Crimp Contact Version: 300 mm²max; Set Screw Version: 120 mm²max
Contact Types: Crimp, Set Screw or Threaded Post (Panel Versions Only)
Contact Retention/Extraction System: Drive Pin with Secondary Lock
Mating Method: Polarization Keyways with Lock Pins
Mating Cycles: 500
Layout: Single Contact with Finger Touch Insulating Tip
Maximum Current Rating: 400A (120 mm² Set Screw), or 800A (300 mm² Crimp)
Maximum Rated Voltage to Ground: 2KVAC; 3KVDC
Test Voltage: 8.000 Vac

Minimum Insulating Resistance: >5x10³ MΩ at 500 Vac
Operating Temperature Range: -30°C to +125°C
Flammability: UL 94 VO
Shell Material: Thermoplastic Resin
Environmental Resistance: Watertight in Mated Condition to IP67
Safety Features: Mechanical and Color-Coded Mis-Mate Protection;
Finger-Proof Contact Nose
Shell Colors: Green, Black, Red, Yellow, Blue, Brown, White, and Grey
Accessories: Compression Sleeves, Lock Pin Release Key, and Protective Covers
Crimp Tools: Industry Standard Crimp Tools and Dies Available for All Crimp, Set Screw and Panel Mount Terminations.

← West Gates

Time	Number	Train	To	Status	Track	Time	Number	Train
8:30A	170	REGIONAL	BOSTON	ON TIME		9:24A	6227	MID DIR
8:30A	470	SHUTTLE	SPRINGFIELD	ON TIME		9:30A		NEWTON
8:32A	6219	MID DIRECT	MONTCLAIR	ON TIME		9:35A	7140	REGIONAL
8:41A	3227	NJCOAST SEC	LONG BRANCH	ON TIME		9:37A	3831	NE COAST
8:52A	3927	NE CORR SEC	TRENTON	ON TIME		9:43A	3231	NJCOAST
9:07A	3929	NE CORR SEC	TRENTON	ON TIME		9:45A	281	EXPRESS
9:11A	3829	NE CORR SEC	TRENTON	ON TIME		9:46A	6619	MID DIR
9:17A	6317	MID DIRECT	BORRIT	ON TIME		10:00A	2153	ACCEL

9:05 SEC-STOPS AT SECAUCUS EHR-STOPS AT NEWARK AIRPORT SEC-STOPS AT NEWARK AIRPORT



Octobyte™

The faster 4/8 pole interconnect system for Ethernet data applications

Glenair series ITH connector with Octobyte™ contacts is available with fully dedicated Ethernet protocol or in a combo version where a mix of signal-power and Ethernet is required. RoHS compliant, IP67 (IP68 on request) exceeds performance expectations typical in harsh environmental applications found throughout rail and industrial markets. OCTOBYTE™ contacts are vibration resistant and designed to work with Ethernet cables from CAT 5 to CAT 7A, MVB-WTB, RG58 Coax.

ITH connectors with Octobyte™ contacts are easy and fast to assemble, making them the best solution for harsh-environment applications where signal reliability is a must.



- Commuter rail
- Passenger information systems (audio/video/digital displays)
- Monitoring and control (braking/doors/lighting/data)
- Heavy industry
- Data control
- Safety systems
- Tested in accordance with:
 - ISO F0 STP: CAT 7A
 - EN50173-1 F600-STP: CAT 7
 - EN50173-1 D STP: CAT 5E



Tested for compliance according to EN50173-1 standards set for CAT5E and CAT7. Testing was conducted using 12 jumpers, each 7.5 meters in length for a total of 90 meters.

ETHERNET CAT 7A CONTACTS



Data Transmission Ethernet Contacts for:	Ethernet CAT 6A
	Ethernet CAT 7
	Ethernet CAT 7A
Featuring:	Internal crimpable contacts
	Inspectable contact
	Integrated cable clamp
	Low mating force
Technical Characteristics:	Current rating: 5A max
	Voltage drop (at 5A and 25°C): 70mV max
Materials and Finish:	Copper alloy and gold plating
Inserts:	Thermoplastic resin

ETHERNET CAT 5 CONTACTS



Data Transmission Contacts for:	Ethernet CAT 5
	Ethernet CAT 5E
	Ethernet CAT 6
	Ethernet CAT 6A
Featuring:	Internal crimpable contacts
	Inspectable contact
	Integrated cable clamp
	Low mating force
Technical Characteristics:	Current rating: 5A max
	Voltage drop (at 5A and 25°C): 70mV max
Materials and Finish:	Copper alloy and gold plating
Inserts:	Thermoplastic resin—UL94V0-NFF16-102 12F3 Exigence 3

COAX CONTACTS



Data Transmission Contacts for:	RG58
Featuring:	Internal crimpable contacts
	Inspectable contact
	Integrated cable clamp
	Low mating force
Technical Characteristics:	Current rating: 5A max
	Voltage drop (at 5A and 25°C): 70mV max
Materials and Finish:	Copper alloy and gold plating
Inserts:	PTFE

ETHERNET MVB - WBT CONTACTS



Data Transmission Contacts for:	MVB - Multifunctional Vehicle Bus
	WTB - Wired Train Bus
Featuring:	Internal crimpable contacts
	Inspectable contact
	Integrated cable clamp
	Low mating force
Technical Characteristics:	Current rating: 5A max
	Voltage drop (at 5A and 25°C): 70mV max
Materials and Finish:	Copper alloy and gold plating
Inserts:	Thermoplastic resin—UL94V0-NFF16-12 12F3 Exigence 3



MARINE BRONZE Seacrow Connectors

For harsh-environment applications

Glenair manufactures connectors qualified to V96929, VG95234 and VG95328 standards. These connectors are mostly used in harsh-environment military applications for ground vehicles and ground systems. Our new Marine Bronze version increases the level of robustness of these connectors to be successfully used in all severe environment navy installations, as well as off-shore platforms, sea ports, geological and oceanographic applications.



- Marine bronze alloy for superior corrosion resistance in seawater and other harsh environments
- Ideal for shipboard and offshore drilling applications
- Available in Series ITS (5015 reverse-bayonet), Series IPT (26482), Series IGE (Single-pole high-voltage VG95234) and Series IT (5015 threaded)
- IP67 environmental sealing in mated condition; IP68 available
- Hundreds of available contact arrangements for both power and signal as well as hybrid applications

Superior corrosion resistance

ITS-MB REVERSE-BAYONET CONNECTORS**VG95234 Compliant Marine Bronze Series**

ITS-MB connectors are compliant with VG95234, using all the same insert arrangements available in the standard ITS Reverse Bayonet Connectors catalogue. Typically they are used for power and signal transmission, with wires from 26 AWG to 4/0. A wide variety of backshells allow the ITS-MB to accept jacketed cables, single or multi-poles, with or without RFI/EMI shielding, conduits with PG or metric thread. IP67 protection is the standard performance. IP68 on request.

IPT-MB MIL-C-26482 HIGH DENSITY CONNECTORS**VG95328 Compliant Marine Bronze Series**

IPT-MB connectors are the choice for reliability when 20-16 AWG signal cables are used. The insert arrangements as well as the electrical characteristics are detailed in the IPT IPT-SE Catalogue. Backshells suitable for EMI shield terminations and heat shrink boots are also available.

The receptacle is also available with PCB contacts. IP67 protection is the standard performance. IP68 on request.

IGE-MB REVERSE-BAYONET SINGLE-POLE CONNECTORS**VG96929 Compliant Marine Bronze Series**

IGE-MB High Power Single Pole Connectors are used with cables from 16 to 240 mmq. These connectors achieve high-performance working current and peak current, and are ideal for engines, power supplies, and power distribution boxes. Several backshells are available, either straight or 90° elbows for the most reliable cable accommodation. See the VG96929 Catalogue for detailed electrical characteristics. IP67 protection is the standard performance. IP68 on request.

IT-MB MIL-C-5015G THREADED CONNECTORS**Marine Bronze Series**

IT-MB is a threaded connector compliant with the MIL-DTL-5015 standard. All the electrical characteristics are available in the IT standard catalogue. IT-MB family is a threaded version mostly used for power and signal, with IP67 standard performance sealing.

**CAN YOU GUESS
THESE
MYSTERIOUS
MACHINES?**

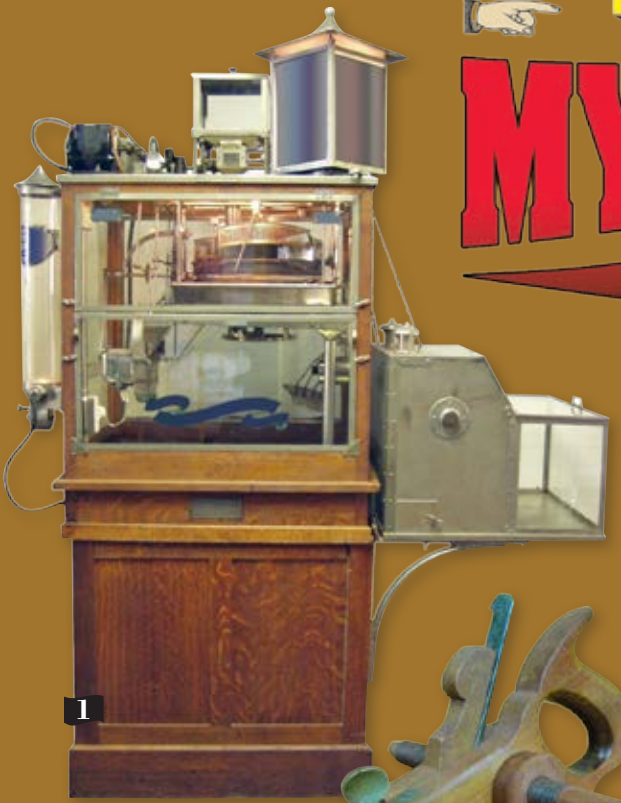

1



2



5

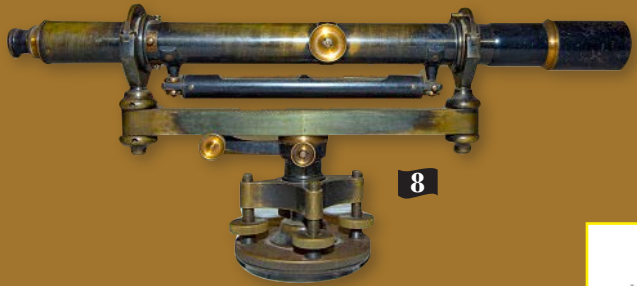

8



11



16

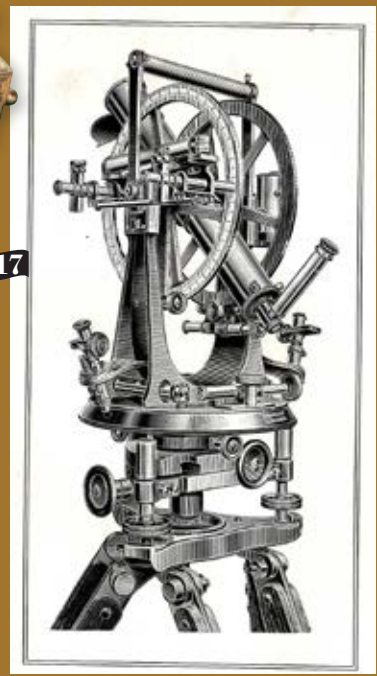

17



12



18

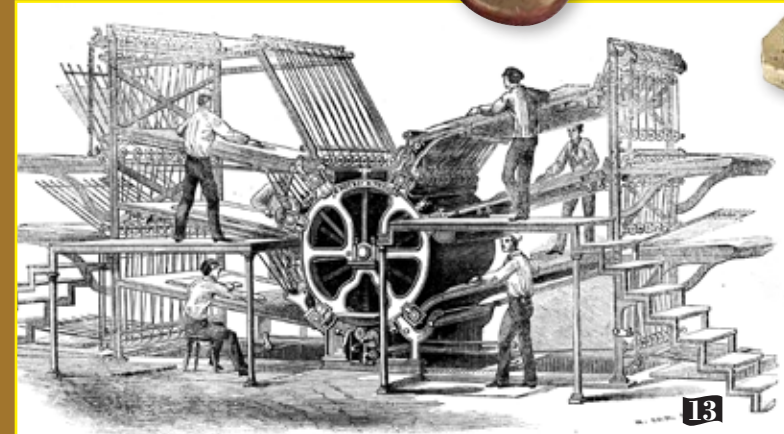

13



9



19



6

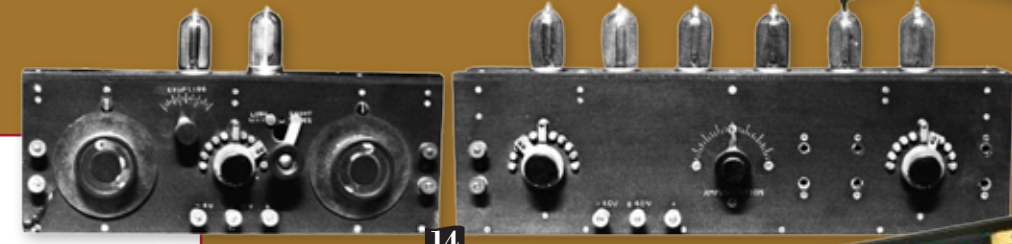

14

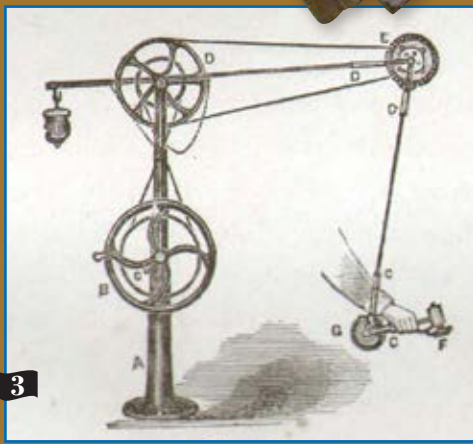

3

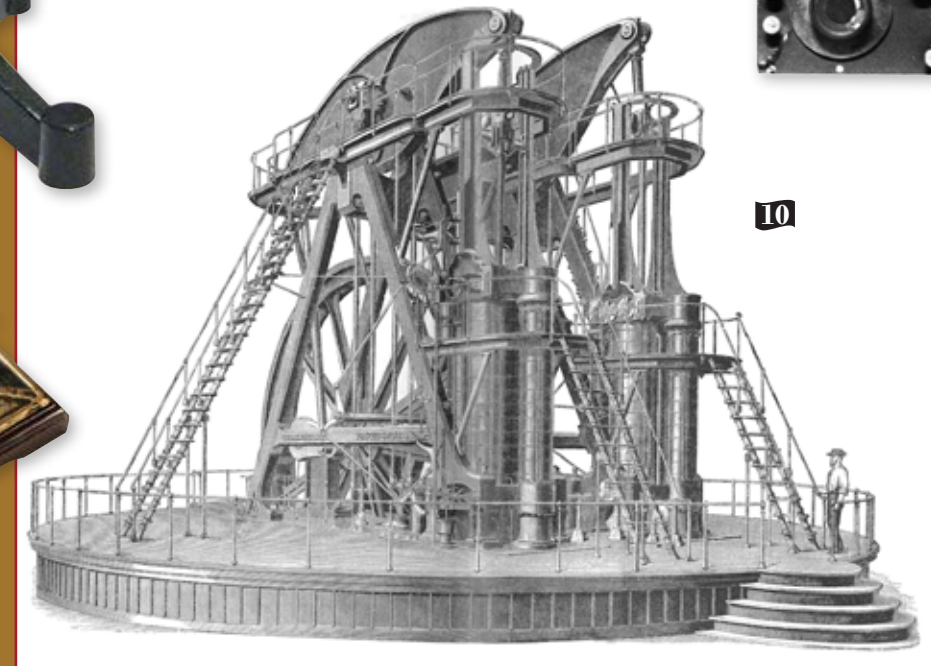

10



7



15



20



4

Answers to be published
February 15th on our website:
www.glenair.com/qwikconnect



RADGRIP™ COUPLING NUTS

For fast, easy mating of ITS Series bayonet connectors plus improved coupling nut mechanical protection



Better grip, improved durability

Glenair ITS-RG Series connector plugs with RadGrip™ rubber coupling nut covers was developed for harsh environmental field applications. RadGrip™ covers feature wide, easy-to-grip castellations as well as a raised thumb tab. Built for maximum durability and mechanical protection of plug coupling nuts, RadGrip™ is the perfect solution for advanced protection against shock and other forms of mechanical damage. In addition, RadGrip™ facilitates rapid mating and demating of connectors, even when surfaces are contaminated with oil, dust, water and other fluids. The highly durable rubber compound may be specified in seven different colors for improved connector and cable identification.

Colors available: Black, Yellow, Red, Blue, Light Green, Orange and Grey.

RadGrip™ material specifications

IAW UNI-CEI 11170 - AFNOR NF-F 16101 - BSS 7239 - ASTM E - 162, ASTM E-662
RadGrip™ covers adhere easily to Aluminum alloy, Stainless steel and Marine bronze.

- Fast, easy 1/4 turn bayonet coupling
- Ergonomically designed for use with arctic gloves
- High Shock and Vibration Resistant
- Compatible with all Series ITS 5015 type connector shell sizes
- Durable chemical-resistant material
- Colored materials facilitate connector and cable identification and/or connector phases

SERIES ITS-RG

RadGrip™ Easy-Mate Rubber Covered Coupling Nut Connectors

Straight and 90° Plugs



90° right-angle plug with RGG cable gland



Straight plug with optional strain relief clamp. Consult factory for additional backshell options in the ITS-RG series

How To Order	
Sample Part Number	ITS G 31 06 RGG 20-27 P Y BK
Product Series	Reverse-Bayonet Coupling Connector
Grounding Fingers	G = Grounding Fingers Omit for Standard
Contact Type	31 = Solder 41 = Crimp
Shell Style	06 = Straight Plug with Accessory Threads 08 = Plug with 90° Backshell
Connector/Backshell Class	RGG = Plug, environmental with rubber-covered coupling nut and cable gland RRG = Plug, environmental with rubber-covered coupling nut and rubber-covered EMI/RFI cable sealing backshell
Shell Size/Insert Arrangement	See Catalog
Contact Gender	P = Pin S = Socket
Alternate Insert Rotation	Omit for Normal
Color Code	BK = Black RD = Red YL = Yellow BL = Blue OR = Orange LG = Light Green GY = Grey

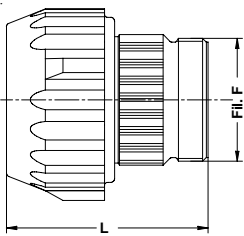

ITS-RGG (06) Straight Plug

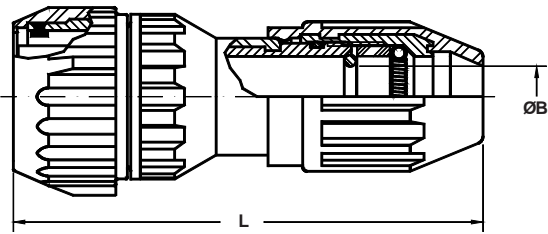
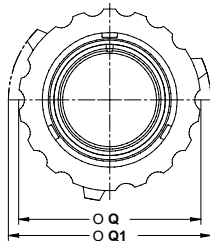

ITS-RRG (06) Straight Plug with EMI/RFI Cable Sealing Backshell

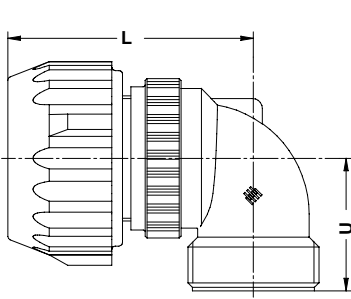

ITS-RGG (08) 90° Right-Angle Plug

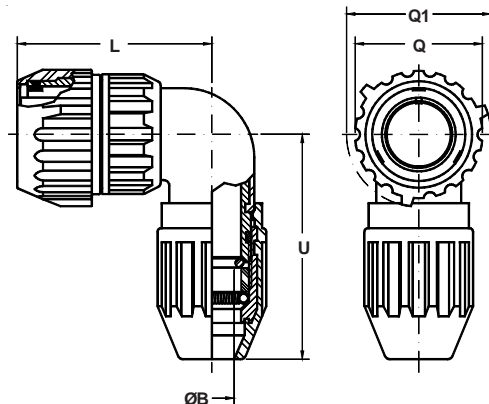
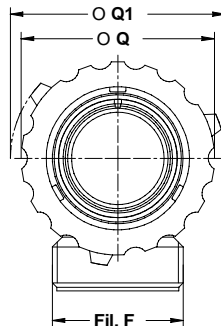

ITS-RRG (08) 90° Right-Angle Plug with EMI/RFI Cable Sealing Backshell



HIGH-TEMPERATURE

Well-Master™ 260°

The Micro-D connector for serious, high-temperature applications

Standard Micro-D connectors are rated for +125°C. Glenair's MWDM Micro-D can withstand +150°C continuous operating temperature and can be upgraded to +200°C if assembled with special high temperature epoxies. But oil, gas and geothermal wells can subject electronic instruments to temperatures as high as +260°C. The GHTM Series Micro-D meets the need for a high density, high performance connector capable of handling this temperature. The GHTM features contacts made from a special alloy that resists softening when exposed to temperatures up to +260°C (500° F). Rugged passivated stainless steel shells and hardware, high temperature liquid crystal polymer (LCP) insulators allow these connectors to survive the most demanding environments. Unique angled mounting ears allow the Well-Master™ 260° to fit in confined spaces.

- +260°C Operating Temperature
- Angled Mounting Ears to Fit in Small Diameter Instruments
- High Reliability TwistPin Contact System with Special High Temperature Alloy
- .050" Pitch Contact Spacing for Reduced Size
- Solder Cup, Pre-Wired or PCB

Well-Master™ **260°**



+260°C PCB Header



+260°C Cable Connector

HIGH TEMPERATURE Well-Master™ 260°



GHTM Micro-D connectors

In addition to extreme high temperature tolerance, and demating resistance to vibration and shock, the Glenair Well-Master™ 260° Micro-D connector features unique shell packaging designed to conform with the cylindrical shape of instrument housings. Special angled mounting ears facilitate incorporation of the connector into available space, and the Micro-D's overall reduced size compared to other rectangular connector solutions allows for more efficient utilization.

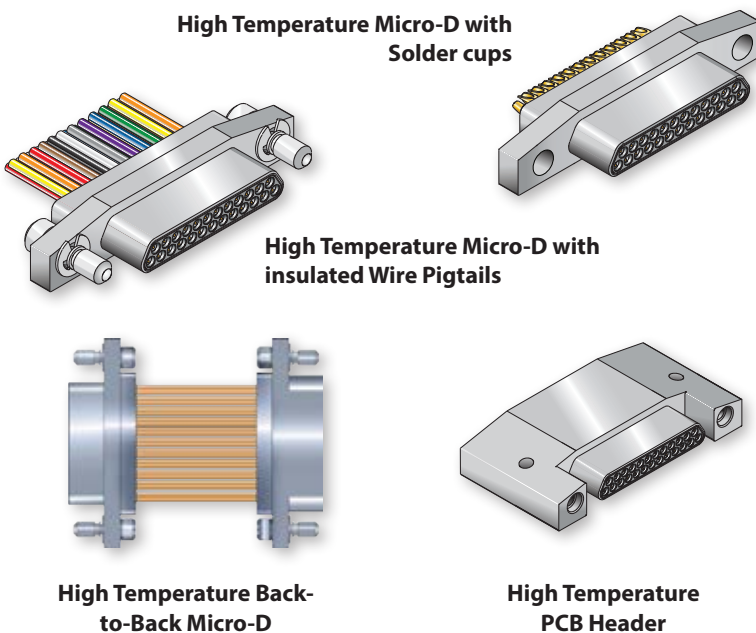

GHTM High Temperature Contact Arrangements			
9	15	21	25
31	37	51	

Mating face of pin connector. Socket connector contact numbers are reversed.

Materials and Finishes	
Contacts	Proprietary nickel alloy, gold plated
Insulators	Liquid crystal polymer (LCP)
Shell	Stainless steel, passivated
Mounting Hardware	Stainless Steel
Insulated Wire	Nickel-coated copper, PTFE insulation per M22759/87 (260°C)

Specifications	
Current Rating	3 Amps
Contact Resistance	8 milliohms maximum
Dielectric Withstanding Voltage	600 Vac sea level
Insulation Resistance	5000 megohms minimum
Operating Temperature	-55° C. to +260° C.
Shock	50 g.
Vibration	20 g.

Lightweight, corrosion-free

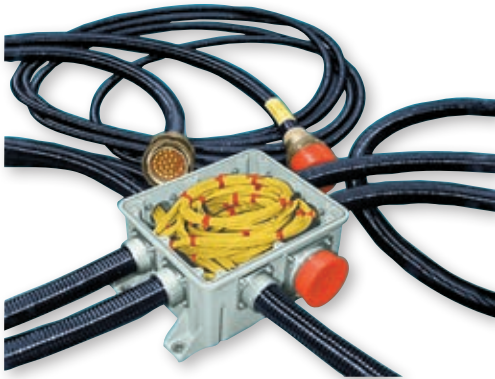

- Over a dozen different tooled sizes and shapes.
- Made-to-order configurations available—just ask.
- Extremely durable, corrosion-free, high temperature engineering composite thermoplastic
- Tested and qualified to U.S. Navy, UK MOD and hundreds of commercial aircraft and marine applications

Glenair EMI/RFI CostSaver Composite Junction Box application—protecting and storing fiber optic media service loops

Install it and forget it: Glenair corrosion-free EMI/RFI shielded composite junction boxes



Ultra-Lightweight and Corrosion-Free

Series 316 stainless steel hardware provides long-term durability

IP67 rated seals and gaskets protect equipment from moisture and dust

Unlimited corrosion resistance compared to metal junction boxes reduces repair and maintenance costs.

Glass-reinforced composite thermoplastic material is strong and durable and yet extremely lightweight.

Low harmonic resonance and inherent attenuating properties reduce loosening and decoupling of feed-through fittings and accessories.





Standard Lipped or Lipless Boots

Transitions

Convuluted Boots



Mechanical and environmental protection/strain relief for connector-to-cable transitions

- Standard, short, long and 90° lipped and lipless boots
- Choice of six boot materials and a complete range of high-performance adhesive types
- A wide range of colors including desert tan
- The industry's largest selection of metal and composite shrink boot adapters
- All popular part numbers in stock and ready for same-day shipment

The industry's broadest selection of heat shrink products



Red straight boot with eyelet

Desert Tan widebody Y transition

Right-angle adapter, purple

4-1 widebody transition, yellow

Green long-tail boot

High-ratio right-angle adapter, grey

Low-profile 3-1 adapter, white

Material Color Options for Type 1 High Performance Elastomer Boots and Transitions

Mod Code	Color	Similar to (Reference)	Mod Code	Color	Similar to (Reference)
632 B	Blue	PANTONE 3005U	632 R	Red	PANTONE 1797U
632 E	Grey	FED-STD-595; #36270	632 T	Tan	FED-STD-595; #33446
632 G	Green	PANTONE 355U	632 W	White	FED-STD-595; #37875
632 P	Purple	FED-STD-595; #37100	632 Y	Yellow	PANTONE YELLOW U
632 O	Orange	FED-STD-595; #32300	Standard	Black	FED-STD-595; #37038

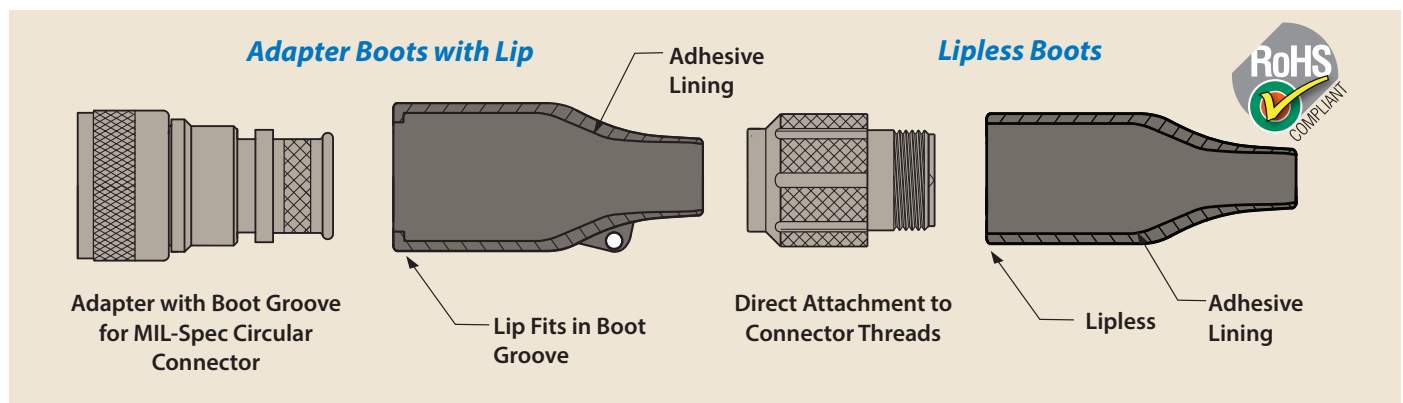



- Complete range of QQ-B-575B/A-A and ASTM B conductive braided shielding solutions
- High performance tubular fabric braided sleeving for every mechanical and wire-protection application requirement
- Broad range of lightweight as well as heavy-duty ground strap/bonding technologies
- Rail industry qualified earth bond tooling and ground studs

World's largest selection of metal and fabric cable shields, ground straps, and tools

100-001 TUBULAR METAL BRAID QQ-B-575B/A-A-59569 ASTM B298 TIN COATED COPPER

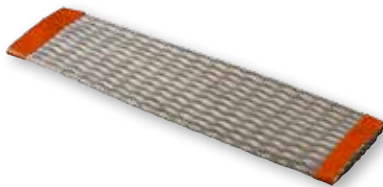

How To Order				
Sample Part Number	100-001	A	XXX	L
Tubular Metal Braid	Tin Coated Copper Braid			
Wire Gauge	A = 36 AWG B = 34 AWG			
Size	Consult Factory			
Lanyard Option	L = Lanyard Omit for none			

100-002 TUBULAR METAL BRAID QQ-B-575B/A-A-59569 ASTM B298 SILVER COATED COPPER



How To Order				
Sample Part Number	100-002	A	XXX	L
Tubular Metal Braid	Silver Coated Copper Braid			
Wire Gauge	A = 36 AWG B = 34 AWG			
Size	Consult Factory			
Lanyard Option	L = Lanyard Omit for none			

100-003 TUBULAR METAL BRAID ASTM B355 CLASS 4 OFHC NICKEL PLATED COPPER



How To Order				
Sample Part Number	100-003	A	XXX	L
Tubular Metal Braid	Nickel Plated Copper Braid			
Wire Gauge	A = 36 AWG B = 34 AWG			
Size	Consult Factory			
Lanyard Option	L = Lanyard Omit for none			

GROUNDING AND SHIELDING TECHNOLOGIES

EMI/RFI braided shielding, ground straps, and earth bond tooling



100-041 TAPERED TUBULAR METAL BRAID



How To Order					
Sample Part Number	100-041	-06	T	10	A
Tubular Metal Braid	Tapered Braid				
Dash No.	Diameters .15 – 1.38, Consult Factory				
Material	A = 100% AmberStrand® B = 75%/25% AmberStrand® L = 100% ArmorLite™		N = Nickel/Copper S = Silver/Copper T = Tin/Copper		
Length	In 1 inch increments				
Wire Gauge	A = 36 AWG, Omit for std. 34 AWG (applies to N, S, T materials only.)				

FABRIC BRAIDED SLEEVING FOR NON-ENVIRONMENTAL WIRE AND CABLE PROTECTION

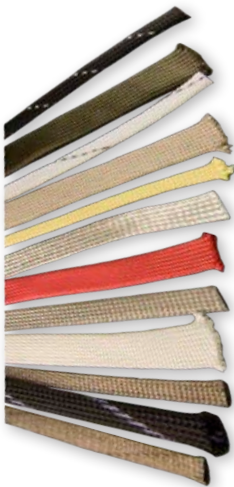

Non-Environmental Fabric Braided Sleeving Types	
Series No.	Type
100-022	PTFE glass tubular braided sleeving
102-001 and -002	Polyethylene expandable fabric tubular braided sleeving; black, green, red, white, and yellow
102-020, -021, -022 and -023	Halar expandable fabric tubular braided sleeving, white or black, with and without tracers
102-073	Dacron tubular braid, black
103-013	Nomex tubular braid; black, white, red, green, gray, and desert tan
102-051	PEEK tubular braid, black
102-061	Teflon tubular braid, clear and natural
102-071	Kevlar tubular braid, natural
102-072	Nylon tubular braid, black

BRAIDED GROUNDING STRAPS



How To Order				
Sample Part Number	107-098	-A	-12	-6
Grounding Strap	107-098 = Single layer light duty ArmorLite 107-099 = Dual layer medium duty ArmorLite			
Material	A = ArmorLite microfilament stainless steel braid			
Width Code	.29 – 1.33 inches			
Length	Dimension in one inch increment			

GROUND CONTROL EARTH BOND SYSTEM



How To Order	
600-120	Hydraulic Setting Tool for 1/4" Earth Bonds
600-123	Hydraulic Setting Tool for 3/8" Earth Bonds
600-124	Hydraulic Setting Tool for M6 Earth Bonds
600-125	Hydraulic Setting Tool for M10 Earth Bonds

The tools feature one hand operation and ram retract mechanism actuated by release trigger. Consult factory for control gauges and earth bond part numbers for each material type and size.



Ultra flexible rope lay construction



Available in a broad range of gages, 12 AWG to 450 MCM

The heart of TurboFlex™ power distribution cable is its ultra-flexible, ultra-fine wire conductor. TurboFlex™ power leads and flexible power transmission cables are made from bare copper, tin/copper, silver/copper or nickel/copper. Each material offers unique electrical performance, including current-carrying capability and temperature range. Ultra-flexible stranded bare copper or silver-plated copper conductors provide optimal conductivity. Tin/copper conductors offer superior solderability, and nickel/copper conductors offer superior corrosion resistance. All TurboFlex™ conductor materials deliver maximum flexibility and ability to handle the high voltage and temperature ranges inherent in such applications as military vehicles, aerospace ground support systems, and charging stations. Duraelectric™, the TurboFlex jacketing (see next page for details) delivers superior flexibility and durability compared to other high-performance jacket materials.



TurboFlex™ is in-stock and available for immediate, same-day shipment. No minimums!

NEC 310.13A (600 V)				
Voltage Rating	AWG	Glenair Part Number	Jacket Thickness	Spark Test Voltage*
600 V	12	961-003-T-A-0	.062"	15,000 V
	10	961-003-T-B-0	.062"	
	8	961-003-T-C-0	.062"	
	6	961-003-T-D-0	.062"	
	4	961-003-T-E-0	.062"	
	2	961-003-T-F-0	.062"	
	0	961-002-T-G-0	.093"	
	2/0	961-002-T-H-0	.093"	
	3/0	961-002-T-I-0	.093"	
	4/0	961-002-T-J-0	.093"	
	250 MCM	961-001-T-K-0	.125"	
	450 MCM	961-001-T-L-0	.125"	

NEC 310.13C (2,400 V)				
Voltage Rating	AWG	Glenair Part Number	Jacket Thickness	Spark Test Voltage*
2,400 V	0	961-001-T-G-0	.125"	15,000 V
	2/0	961-001-T-H-0	.125"	
	3/0	961-001-T-I-0	.125"	
	4/0	961-001-T-J-0	.125"	
	250 MCM	961-001-T-K-0	.125"	
	450 MCM	961-001-T-L-0	.125"	

NEMA HP 6, Type S (600 V)				
Voltage Rating	AWG	Glenair Part Number	Jacket Thickness	Spark Test Voltage*
600 V	12	961-004-T-A-0	.032"	15,000 V
	10	961-004-T-B-0	.032"	

NEC 310.13B (2,000 V)				
Voltage Rating	AWG	Glenair Part Number	Jacket Thickness	Spark Test Voltage*
2,000 V	12	961-003-T-A-0	.062"	15,000 V
	10	961-003-T-B-0	.062"	
	8	961-002-T-C-0	.093"	
	6	961-002-T-D-0	.093"	
	4	961-002-T-E-0	.093"	
	2	961-002-T-F-0	.093"	
	0	961-002-T-G-0	.093"	
	2/0	961-002-T-H-0	.093"	
	3/0	961-002-T-I-0	.093"	
	4/0	961-002-T-J-0	.093"	
	250 MCM	961-001-T-K-0	.125"	
	450 MCM	961-001-T-L-0	.125"	

NEMA HP 6, Type SS (1,000 V)				
Voltage Rating	AWG	Glenair Part Number	Jacket Thickness	Spark Test Voltage*
1,000 V	12	961-003-T-A-0	.032"	15,000 V
	10	961-0 3-T-B-0	.032"	
	6	961-002-T-D-0	.093"	
	4	961-002-T-E-0	.093"	
	2	961-002-T-F-0	.093"	
	0	961-002-T-G-0	.093"	
	2/0	961-002-T-H-0	.093"	
	3/0	961-002-T-I-0	.093"	
	4/0	961-002-T-J-0	.093"	
	250 MCM	961-002-T-K-0	.093"	
	450 MCM	961-002-T-L-0	.093"	

*performed by Glenair



Rugged high-temperature, environmental Duraelectric™ jacketing is available in a broad range of and colors including safety orange

Duraelectric™ is the high-performance TurboFlex™ jacketing material perfectly suited for immersion, chemical or caustic fluid exposure, temperature extremes, UV radiation and more

Glenair Duraelectric™ weatherproof jacketing is halogen free, flame resistant, and functional to 260°C. Duraelectric™ far surpasses the accelerated solar weathering standards under IEC 60068-2-5, and is tested to 56 accelerated days, equivalent to 53 years of solar exposure. Glenair can supply the material in a variety of formats, including blown jacketing, as an extrusion over wire and cable, as an overmolding compound and as a self-vulcanizing repair tape.

Jacketing Options		
0	Black	Weatherproof, halogen free, flame resistant, functional to 260°C
1	Desert Tan	Fed Std #33446 Desert Tan color
2	Red	Pantone® 1797 U
3	Orange	OSHA Safety Orange to mark energized electrical cables
4	Yellow	Pantone® Yellow U
5	Green	Pantone® 355 U
6	Blue	Pantone® 3005 U
7	Violet	Fed Std 595; #37100
8	Gray	Qualified to US Navy MIL-PRF-24758A, Fed Std 595B #26270 Haze Gray color
9	White	Fed Std 595; #37875

Jacketing Material Properties	
Material Property	Duraelectric™
Temperature Range	-60°C to +260°C
Specific Gravity	1.22
Weight: Lbs./Cubic Inch	.045
Abrasion Resistance	Good
Wear Resistance	Good
Flame Resistance	Excellent
Sunlight Resistance	Excellent
Chemical Resistance	
Aliphatic Hydrocarbons	Excellent
Aromatic Hydrocarbons	Excellent
Ketones, Etc.	Excellent
Oil & Gasoline	Excellent

Glenair Duraelectric™ Material Specifications	
Temperature rating: -60°C to +260°C (with excursions to 290°C)	
Halogen free per IEC 60614-1. Less than 5mg of hcl per 1 gm of product tested.	
Accelerated Weathering (Solar) per IEC 60068-2-5; 56 days exposure	
Flame Resistant per IEC 60614-1; Material does not sustain combustion when the source of flame is removed.	
Low Smoke Index per NES 711 (11.75); Minimum standard is 25. The Glenair tested level is 11.75. This makes the material acceptable for interior applications as well as topside.	
Smoke Density Class F1 Per NF F 16-101 IAW DIN EN 60695-2-11:2001	
Toxicity Index per NES 713 (1.9); Minimum standard is 5. The Glenair tested level is 1.9. This makes the material acceptable for interior applications as well as topside.	
Colorable to Fed Std 595B	
Markable IAW MIL-PRF-24758A	
Oxygen Limiting Index = 45.1 Per EN ISO 4589-2:1999; Minimum is 28.	
ASTME E 595 vacuum outgassing–post bake results: TML .06%, CVCM .006%, WVR .02%	
Fungus resistance testing (rating of 0) per MIL-STD-810F, method 508.5	
ASTM D624 DIE B tear test: 150 KN/M	
12 Sec Vertical Burn: (Pass) Per 14CFR Part 25.853(a) amdt 25-116 App F Part 1 (a)(1)(ii)	
Fluids Per MIL STD 810F, Method 504	Cleaner (MIL-C-85570): CALLA-855
Fuel (MIL-T-83133): JPG	Solvent (Isopropyl Alcohol): TT-I-735
Fuel (MIL-T-83133): JPG	De Icer (AMS-1432): E36 Runway Deicer
Hydraulic Fluid (MIL H 5606): ROYCO 756	Coolant (MIL-C-87252): Coolanol 25R
Lube Oil (MIL-L-23699): ROYCO-500	Fire Extinguishant Foam: AMEREX AFFF



Standard Black and Natural/Clear Annular Tubing

Blue, Yellow, Red, Desert Tan, and Orange Annular Polymer-Core Tubing

- **Lightweight, flexible polymer-core materials and easy to install fittings, transitions and adapters**
- **Choice of three tubing material choices: Kynar, PVDF and G-FLEX Siltem**
- **Choice of turnkey, factory-terminated assemblies or user-installable configurations**



Compact Environmental Sentry System

Easy-to-Install Guardian System

High-performance annular convoluted tubing provides an economical, lightweight and durable enclosure for interconnect wiring

Part Number 120-144



For non-environmental and non-EMI/RFI applications

Strong, abrasion resistant annular conduit tubing, supplied in thermally stabilized Kynar®, PVDF, or medium duty Siltem. Available in 7 colors, standard or slit.

Part Number 121-190



For non-environmental EMI/RFI applications

Annular conduit tubing with braided shield for EMI/RFI protection and additional structural integrity, particularly pull (tensile) strength.

Part Number 121-191



For environmental EMI/RFI applications

Annular conduit tubing with braided shielding for EMI/RFI protection and a ruggedized jacket for environmental protection against dust, dirt, and moisture incursion.

Part Number 121-192



For non-environmental EMI/RFI applications with high dB shielding requirements

Annular conduit tubing with double braided shield for high frequency EMI/RFI protection and mechanical strength.

Part Number 121-193



For environmental EMI/RFI applications with high dB shielding requirements

Annular conduit tubing with double braided shield and jacket for optimum EMI/RFI protection, strength and environmental sealing.



Easy
Assembly
Hat Trick
System



Super
Durable
Internal Braid
System



Ultra
Lightweight
Composite
Hammer Nut
System

- **Lightweight, flexible helical polymer-core materials and easy to install fittings, transitions and adapters**
- **Choice of five materials: ETFE, FEP, PFA, PTFE, and low-smoke, halogen-free PEEK**
- **Choice of turnkey, factory-terminated assemblies or user-installable configurations**
- **All popular part numbers in stock and ready for same-day shipment**

Series 74 High-performance helical convoluted tubing, backshells, fittings and assemblies



Part Number
120-100

Outstanding mechanical wire protection and lubricity for non-environmental and non-EMI/RFI applications

Helical plastic convoluted tubing, available in a choice of 5 materials. Choose standard black or clear color.



Part Number
121-101

Adds EMI/RFI braided shielding for use in non-environmental applications

Helical plastic convoluted tubing, available in a choice of 5 materials, with a single braided shield for EMI/RFI protection.



Part Number
121-102

Adds a second layer of high dB EMI/RFI shielding for use in non-environmental applications

Helical plastic convoluted tubing, available in a choice of 5 materials, with double braided shield for high frequency shielding applications.



Part Number
121-100

A jacketed configuration with one EMI/RFI shield for use in environmental applications

Helical plastic convoluted tubing, available in a choice of 5 materials, with braided shielding for EMI/RFI protection and a ruggedized jacket for environmental protection.



Part Number
121-103

Double-braided and jacketed configuration for environmental and high dB EMI/RFI shielding protection

Helical plastic convoluted tubing, available in a choice of 5 materials with double shielding and jacket for optimum EMI/RFI protection and environmental sealing.



Part Number
123-100

For environmental applications without EMI shielding requirements

Helical convoluted tubing in choice of 5 materials with a ruggedized jacket for environmental protection.



Part Number
121-195

Internal braid configuration for harsh chemical environment applications, with EMI/RFI shielding

Chemical- and UV-resistant plastic conduit tubing with internal braid for weight savings and harsh-environment EMI/RFI protection.



Copper-clad nickel iron conduit

- Hermetically sealed, flexible metal-core conduit for interconnect applications
- Choice of three materials: Brass, Stainless Steel, and Nickel Iron Alloy
- Turnkey, factory-terminated assemblies for landing gear and other rugged aerospace applications
- All materials deliver superior EMC performance as well as crush resistance and environmental sealing

The ultimate in highly flexible, crush-proof EMI/RFI protection: Series 75 helically-wound metal-core conduit

**Part Number
750-190**



Superior EMI protection and crush-proof strength for static applications

Highly flexible crush-proof metal conduit, available in Nickel-Iron, Brass, or SST.

**Part Number
750-191**



Adds braided shielding for additional tensile strength applications

Flexible metal-core conduit tubing with numerous braided shielding options, for additional tensile strength and effective grounding of electromagnetic interference.

**Part Number
750-192**



Adds a jacket for environmental protection

Flexible metal-core conduit tubing with braided shielding plus a ruggedized jacket for environmental protection against contaminants and moisture.

**Part Number
750-193**



Adds a second braided shield for high dB EMI/RFI shielding

Flexible metal-core conduit tubing with double braided shield for high frequency EMI/RFI shielding requirements.

**Part Number
750-194**



A jacketed, double-braided configuration for combined environmental and EMI/RFI applications with high dB shielding requirements

Flexible metal-core conduit tubing with double braided shield and jacket for optimum EMI/RFI protection, strength and environmental sealing.

**Part Number
750-195**



Triple-braided conduit for predictable and reliable grounding of surface-borne/high frequency electromagnetic interference

Flexible metal-core conduit tubing with triple braided shield for optimal tensile strength and enhanced high frequency EMI/RFI protection.

**Part Number
750-196**



Triple-braided and jacketed conduit for maximum EMI shielding in environmental applications

Flexible metal-core conduit tubing with triple braided shield and jacket for enhanced high-frequency EMI/RFI protection, strength and environmental sealing.

Conduit Material Choices, Material Properties, and Military Specifications			
Glenair Code	Material	Properties	Applicable Military Specifications
B	Brass, Per A-A-52440 Type I, Grade B	Optimal EMI shielding when combined with bronze overbraid. Generally specified with bronze overbraid and jacket.	<ul style="list-style-type: none"> ■ IAW A-A-52440 (Covering shielded, electrical, flexible, metal conduit for use as protection of wiring in military vehicles from mechanical injury and, when properly installed and grounded, to prevent radiation that may cause interference with radio and other electronic equipment.)
C	Stainless Steel AISI 316	Specified for high-temperature, corrosion, and crush resistance. Nominal shielding value. Typically braided with stainless steel braid for additional pull strength and durability. Available with or without a jacket.	<ul style="list-style-type: none"> ■ MIL-C-13909 (Superseded by IAW-A-A-52440 above) ■ MIL-PRF-24758 (Covering the performance requirements for weatherproof flexible conduit systems for use primarily in exposed areas on U.S. Navy ships, to shield against electromagnetic (EM) radiation from own-ship transmitters and emissions external to the ship, electromagnetic pulse (EMP) events, and to minimize corrosion while being field repairable to reduce maintenance.)
N	Nickel Iron Alloy Type 4 ANSI/ASTM-A-753	80% Nickel, 20% Iron. Optimal low-frequency shielding material. Typically braided with stainless steel braid for additional pull strength and durability. Available with or without a jacket.	<ul style="list-style-type: none"> ■ MIL-DTL-28840 (Covering Connectors, Electrical, Circular, Threaded, High Shock, High Density, Shipboard, Metal Conduit, for EMI Shielding)

EMI/RFI Braided Shielding and Non-Metallic (Fabric) Overbraids		
B	Bronze	Standard for for brass core conduit
T	Tin/Copper	150°C temperature rating, 125 lbs. tensile strength, 96 hr. salt spray corrosion resistance
C	Stainless Steel	Highest tensile strength (225 lbs.), highest temperature—1093°C+
N	Nickel/Copper	200°C temperature rated, 150 lbs. tensile strength, 500 hrs. salt spray corrosion resistance
S	SnCuFe	Tin plated iron/copper
L	ArmorLite™	Microfilament metal-clad ultra lightweight stainless steel braid
D	Dacron	Yarn with excellent abrasion resistance, good chemical resistance, non-conductive
M	Nomex	-55°C to 260°C temperature range - will not melt, excellent chemical resistance, non-conductive
E	AmberStrand® 100%	Expandable, flexible, high-strength conductive metal-clad composite thermoplastic
F	AmberStrand® 75%/25%	75% Expandable, flexible, high-strength conductive metal-clad composite thermoplastic combined with 25% nickel-plated 36AWG copper wire for additional strength

Series 75 Metal-Core Helically-Wound Conduit Product Selection Guide

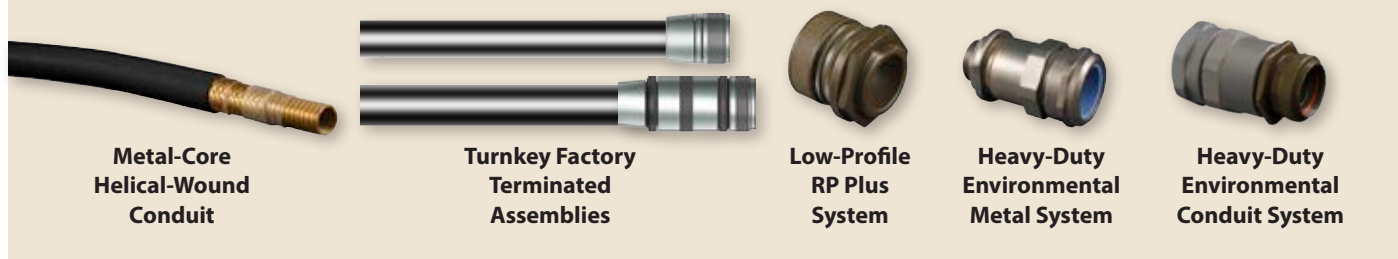

BAND-MASTER™ ATS EMI/RFI Shield Termination System



The advanced termination system for interconnect cable shielding



- Fast, cost-effective cable shielding termination
- Precision hand-held tool and bands deliver reliable, repeatable performance
- Single piece stainless steel bands in various sizes and lengths
- Clamp both small and large diameters easily and reliably
- Pneumatic banding tool for high-speed mass production
- Qualified for both military and commercial aviation

The Band-Master™ ATS provides quick, easy, cost-effective and highly reliable termination of braided metallic shielding or fabric braid to connectors and backshells.

Band-Master™ ATS is the advanced termination system for interconnect cable shielding. The unique low profile and smooth inside diameter of the one-piece type 304 austenitic stainless steel clamping band virtually eliminates RFI/EMI/EMP leakage paths. The lock maintains constant tension under extreme environmental conditions. Band-Master™ ATS bands have passed severe shock, vibration and thermal cycle testing with negligible deterioration of shell conductivity.



BAND-MASTER™ ATS ADVANCED TERMINATION SYSTEM



Easy-to-use manual tools with built-in calibration counter



High-volume pneumatic tool for bench use







Save time and tool maintenance costs with the Glenair band tool calibration system

BAND-MASTER™ ATS EMI/RFI Shield Termination System



The advanced termination system for interconnect cable shielding

Band-Master™ ATS Manual Tool Selection	
	<p>601-100 Hand Tool for Standard Bands</p> <p>The 601-100 Standard Band-Master™ ATS Tool weighs 1.18 lbs., and is designed for standard flat .24" width clamping bands (601-005, 601-040 and 601-049) in a tension range from 100 to 180 lbs. Calibrate at 150 lbs. ± 5 lbs. for most shield terminations. Tool and band should never be lubricated.</p>
	<p>601-101 Hand Tool for Micro Bands</p> <p>The 601-101 Micro Band-Master™ ATS Tool weighs 1.18 lbs., and is designed for micro .120" width clamping bands (601-024, 601-060 and 601-064) in a tension range from 50 to 85 lbs. Calibrate at 80 lbs ±5 lbs. for most shield terminations. Tool and band should never be lubricated.</p>
	<p>601-108 Hand Tool for Nano Bands</p> <p>The 601-108 Nano Band-Master™ ATS Tool weighs 1.18 lbs., and is designed for nano flat .075" width clamping bands (601-500, 601-504 and 601-508) in a tension range from 20 to 50 lbs. Calibrate at 50 lbs. ± 3 lbs. for most shield terminations. Tool and band should never be lubricated.</p>
	<p>601-109 Hand Tool for Slim Bands</p> <p>The 601-109 Slim Band-Master™ ATS Tool weighs 1.2 lbs., and is designed for slim standard flat .24" width clamping bands (601-570, 601-571, 601-572 and 601-573) in a tension range from 50 to 100 lbs. Calibrate at 100 lbs. ± 5 lbs. for most shield terminations. Tool and band should never be lubricated.</p>



3 lengths and 3 widths of EMI braid termination bands plus new slim bands for size and weight savings—50% lighter and lower-profile than standard bands.

Bands	Band-Master™ ATS Band Selection					
	Length		Part Number		Fits Diameter	
	in.	mm.	Flat	Pre-Coiled	in.	mm.
Short Standard Band	9.0	228.6	601-005	601-006	1.0	25.4
Medium Standard Band	14.0	355.6	601-040	601-041	1.8	47.8
Long Standard Band	18.0	457.2	601-049	601-050	2.5	63.5
Short Micro Band	5.0	127.0	601-024	601-025	0.5	12.7
Medium Micro Band	8.0	203.2	601-060	601-061	.88	22.4
Long Micro Band	14.0	355.6	601-064	601-065	1.8	47.8
Short Nano Band	6.0	152.4	601-500	601-501	.60	15.2
Medium Nano Band	9.0	228.6	601-504	601-505	.94	23.9
Long Nano Band	14.0	355.6	601-508	601-509	1.8	47.8
Short Slim Standard Band	9.0	228.6	601-570	601-571	.94	25.4
Medium Slim Standard Band	14.25	362.0	601-572	601-573	1.8	47.8

Glenair industrial/rail interconnect solutions are at home in a broad range of application environments— from nuclear facilities to metro cars



Glenair is the world's only supplier of 5015 type (Series ITS reverse-bayonet) connectors that also manufactures a complete range of wire and cable protection systems such as this engine compartment conduit assembly.

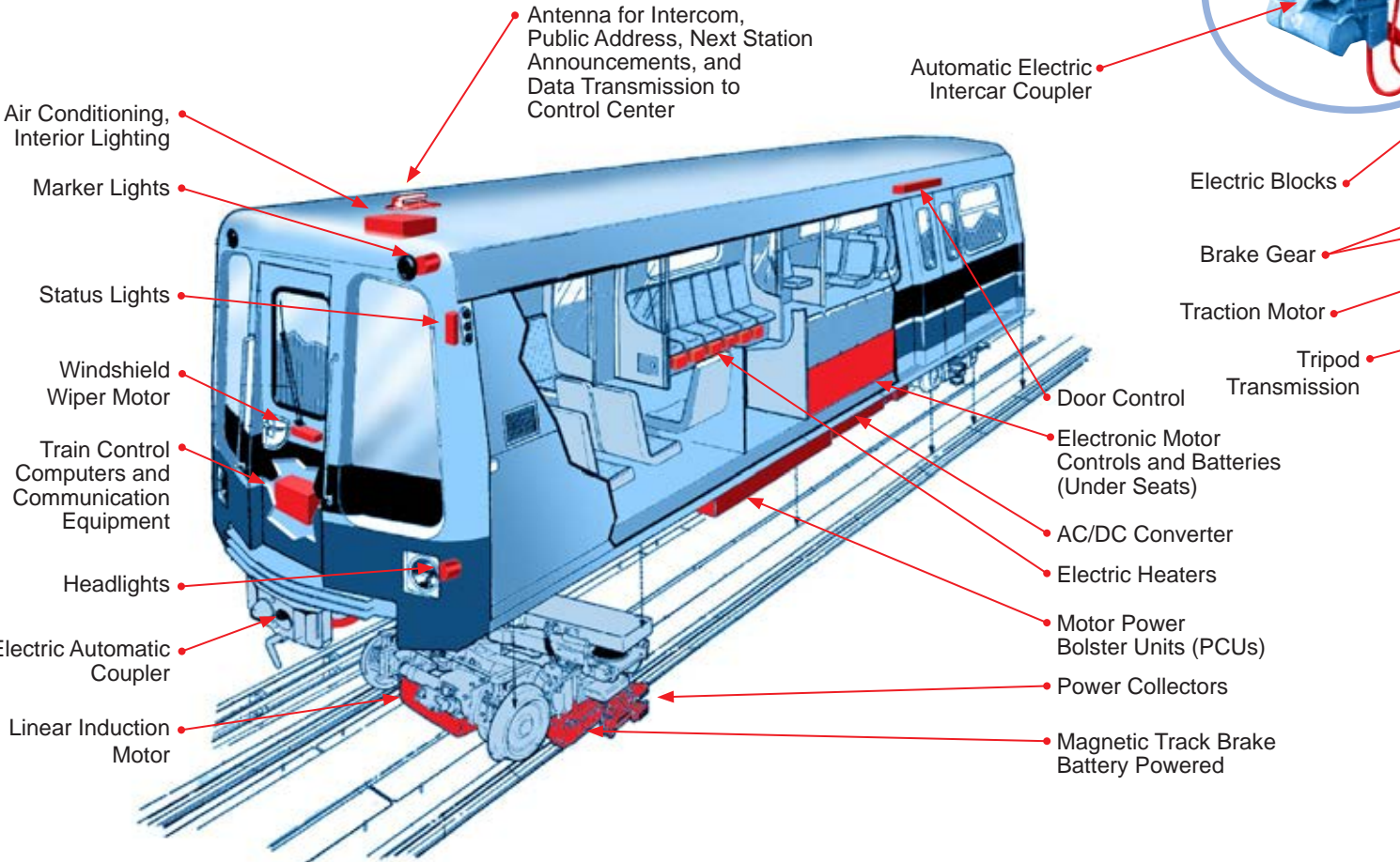
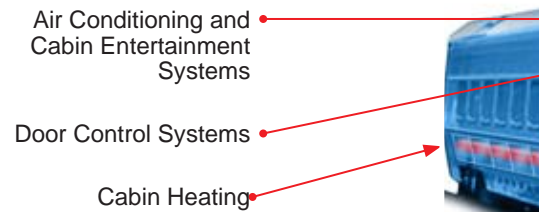

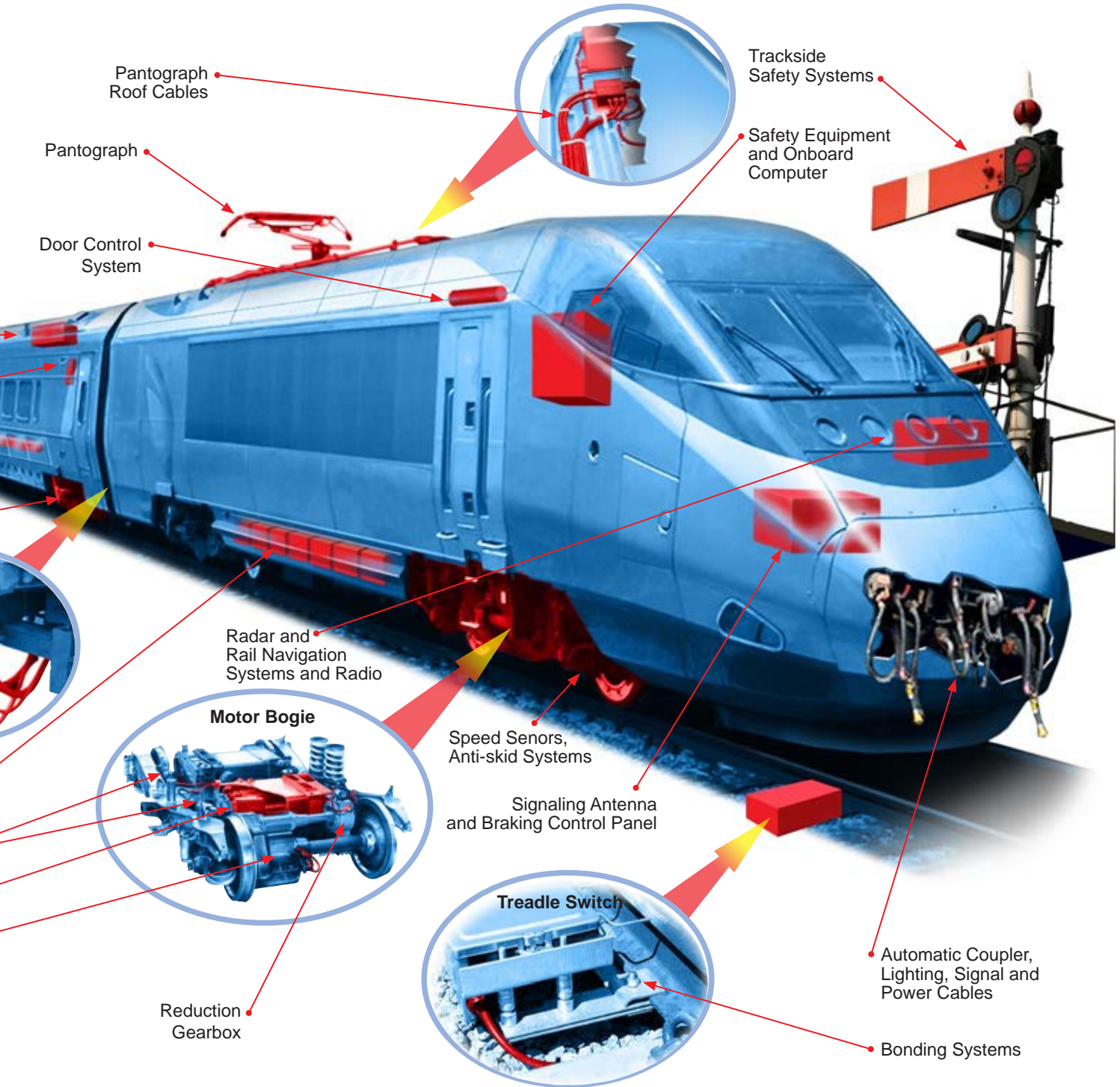

A World of Rail Industry Interconnect Solutions

Glenair supplies a comprehensive line of high-reliability interconnect solutions for the rail industry: from MIL-DTL-5015 type reverse bayonet power and signal connectors, to traction motor connectors, corrosion-proof junction boxes, overmolded cable assemblies, conduit wire protection products and more. We are the go-to manufacturer of purpose designed interconnect cabling for the most challenging rail interconnect applications.



It Ain't a Microwave

I recently heard some remarks from the chief operations officer for a major railroad line. It gave me a new appreciation for just how complicated and difficult that business is. He used an expression, "It ain't a microwave," that I know will really hit home for the Glenair family—or for that matter anyone who is involved in a business.

Glenair only does a small percentage of our "industrial strength" connector business with freight outfits (most of our rail connectors go into "more sophisticated" and technology-rich passenger/metro trains). But while the technology is pretty straightforward, the freight side of the industry is anything but unsophisticated. Just imagine the attention to detail required to load, transport and deliver the millions of tons of cargo moved on trains every year. Samuel Jackson's character in *Jurassic Park* remarked that the operation had "All the complexities of a major theme park and a zoo" rolled into one. But the railroad freight business has him beat.

For example, the typical rail freight operations report for a single day is a thick stack of incidents running the gamut from vandalism to theft to train/automobile accidents. On a trip from the mid-west to the west coast, a freight train passes through regulatory environments of a dozen states. It may be subject to any number of weather-related bottlenecks—from floods to snow storms to forest fires. Safety issues abound; shipments require constant tracking, hazardous material transport is highly regulated, late-deliveries get penalized, labor disputes can erupt, rolling stock and track maintenance issues surprise—the list goes on and on. And every problem/delay has a ripple effect impacting the entire system. As the railroader explained, "It ain't a microwave. You don't get to just take a problem, pop it in a microwave and serve up a hot solution. Everything is interrelated and full of unexpected consequences. Everything requires great care and attention to detail."

Returning to Glenair, the same can be said of our operation. Many aspects of what we do are not necessarily "sophisticated" but, taken together, are extremely complex. Just look at a "simple" connector with its dozens of metal and resilient component parts, qualification inspections and approvals, material sourcing requirements, tight dimensional tolerances, plating specifications, lead time deadlines and so on—and imagine how many ways there are for something to go wrong. And of course we don't just manufacture a single flavor of connector, but tens of thousands of unique part numbers every year.

We love what we do here at Glenair and are proud of the important role our products play in keeping the world moving, communicating, and advancing to a better and safer quality of life. But like the man said, "It's not a microwave." The complexities of our business—and the value our products and services provide—go hand in hand. And that, my friends, is what makes it all worth doing.

Chris Toomey

Publisher

Christopher J. Toomey

Executive Editor

Marcus Kaufman

Managing Editor

Carl Foote

Editor/Art Director

Mike Borgsdorf

Graphic Designer

George Ramirez

Technical Consultant

Jim Donaldson

Issue Contributors

Becki Archuleta

Deniz Armani

Peter Bialobrzewski

Paul Bougie

Greg Cameron

Ken Cerniak

Ralph Hays

Gary Holdredge

Roberto Leprotti

Linda Liotus

Sheila Melcher

Kevin Nottage

Jim Plessas

Giorgio Salvatori

Fred VanWyk

Distribution

Terry White

QwikConnect is published quarterly by Glenair, Inc. and printed in the U.S.A. All rights reserved. © Copyright 2014 Glenair, Inc. A complete archive of past issues of QwikConnect is available on the Internet at www.glenair.com/qwikconnect

GLENNAIR, INC.

1211 AIR WAY
 GLENDALE, CA 91201-2497
 TEL: 818-247-6000
 FAX: 818-500-9912
 E-MAIL: sales@glenair.com
www.glenair.com

