

SERIES 80

Mighty Mouse Connectors and Cables



Size 20/23, 16/23, and 12/23 Combo Contact Layouts and PCB Footprints; Tested at 1300 VAC

SIZE 16 AND 23 COMBINATION CONTACT ARRANGEMENTS

Inert Arrangement
Mating Face View of Pin Contacts

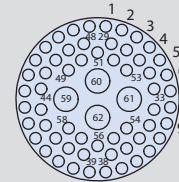
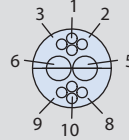
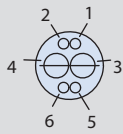

PCB Footprint

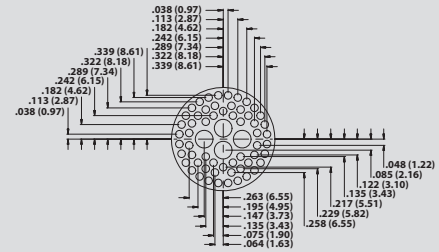
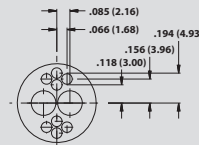
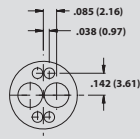

Series 800, 802, 803, 804	9-200		10-202		15-206	
Series 801	9-200		10-202		17-206	
Series 805	11-200		12-202		19-206	
Contact Size	#16	#23	#16	#23	#16	#23
No. of Contacts	2	4	2	8	4	58

SIZE 12 AND 23 COMBINATION CONTACT ARRANGEMENTS

Inert Arrangement
Mating Face View of Pin Contacts

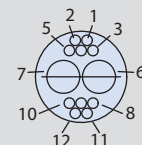
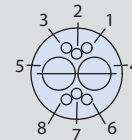
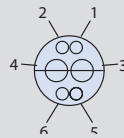
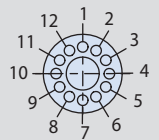

PCB Footprint

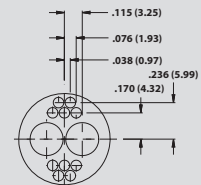
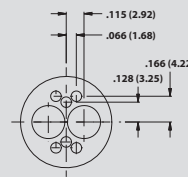
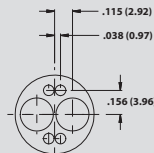
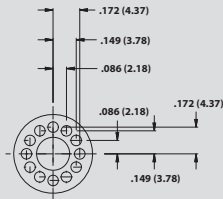

Series 800, 802, 803, 804	10-200		10-201		12-200		12-201	
Series 801	10-200		10-201		13-200		13-201	
Series 805	12-200		12-201		15-200		15-201	
Contact Size	#12	#23	#12	#23	#12	#23	#12	#23
No. of Contacts	1	12	2	4	2	6	2	10

General Information and Reference

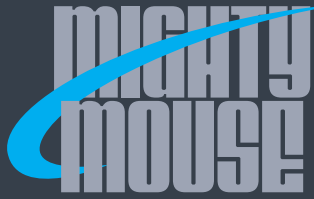

SERIES 80

Mighty Mouse Connectors and Cables



Size 16/23, 12/23, and 8/23 Combo Contact Layouts and PCB Footprints; Tested at 1300 VAC

Contact Size, Quantity and Specifications						Contact Arrangement					
#23	#16	#12	#8	AWG Accepted	Tested Vac	Series 800	Series 801	Series 802	Series 803	Series 804	Series 805
20	2			#22-#28	1300	12-202	13-202	12-202	12-202	12-202	15-202
12	4			#22-#28	1300	12-203	13-203	12-203	12-203	12-203	15-203
40	2			#22-#28	1300	N/A	16-204	14-204	14-204	14-204	18-204
32	4			#22-#28	1300	N/A	16-205	14-205	14-205	14-205	18-205
40	4			#22-#28	1300	N/A	17-203	15-203	N/A	N/A	19-203
58	4			#22-#28	1300	N/A	17-206	15-206	N/A	N/A	19-206
12		2		#22-#28	1300	12-204	13-204	12-204	12-204	12-204	15-204
4		4		#22-#28	1300	12-205	13-205	12-205	12-205	12-205	15-205
34		2		#22-#28	1300	N/A	16-206	14-206	14-206	14-206	18-206
20		4		#22-#28	1300	N/A	16-207	14-207	14-207	14-207	18-207
28		4		#22-#28	1300	N/A	17-204	15-204	N/A	N/A	19-204
18			1	#22-#28	1300	N/A	11-201	11-201	N/A	11-201	13-201
32			1	#22-#28	1300	N/A	16-208	14-208	N/A	14-208	18-208
40			1	#22-#28	1300	N/A	17-205	15-205	N/A	N/A	19-205
44			2	#22-#28	1300	N/A	19-201	19-201	N/A	N/A	21-201
12			4	#22-#28	1300	N/A	19-202	19-202	N/A	N/A	21-202
28			4	#22-#28	1300	N/A	21-200	21-200	N/A	N/A	23-200

SIZE 16 AND 23 COMBO CONTACT ARRANGEMENTS

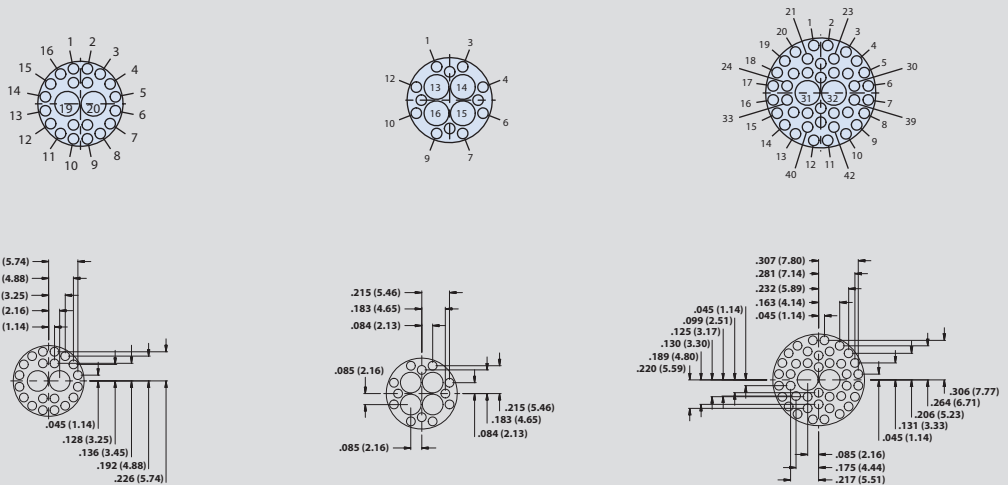

Series 800, 802, 803, 804	12-202		12-203		14-204 ¹	
Series 801	13-202		13-203		16-204	
Series 805	15-202		15-203		18-204	
Contact Size	#16	#23	#16	#23	#16	#23
No. of Contacts	2	20	4	12	2	40

1. Not available for Series 800 2. Not available for Series 803 or 804

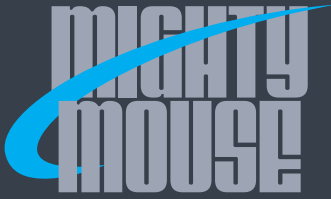

SERIES 80

Mighty Mouse Connectors and Cables



Size 16/23, 12/23, and 8/23 Combo Contact Layouts and PCB Footprints; Tested at 1300 VAC

SIZE 16 AND 23 COMBO CONTACT ARRANGEMENTS

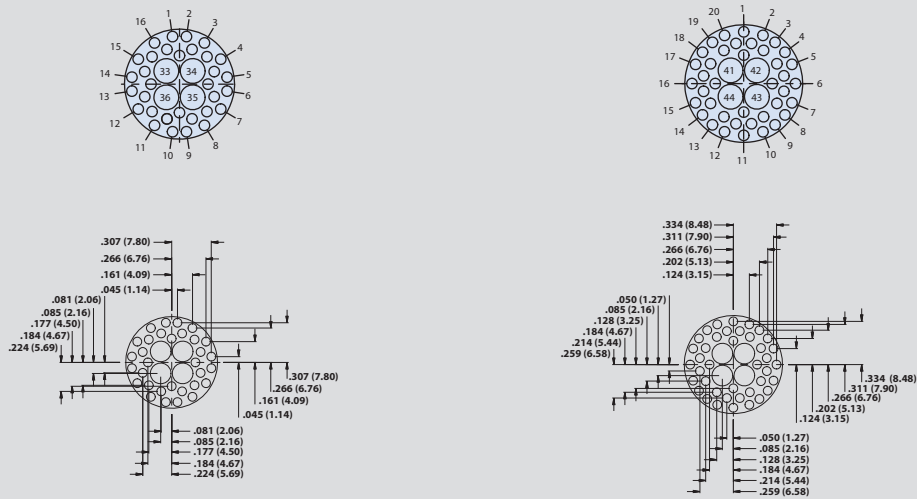

Series 800, 802, 803, 804	14-205 ¹		15-203 ^{1,2}	
Series 801	16-205		17-203	
Series 805	18-205		19-203	
Contact Size	#16	#23	#16	#23
No. of Contacts	4	32	4	40

SIZE 12 AND 23 COMBO CONTACT ARRANGEMENTS

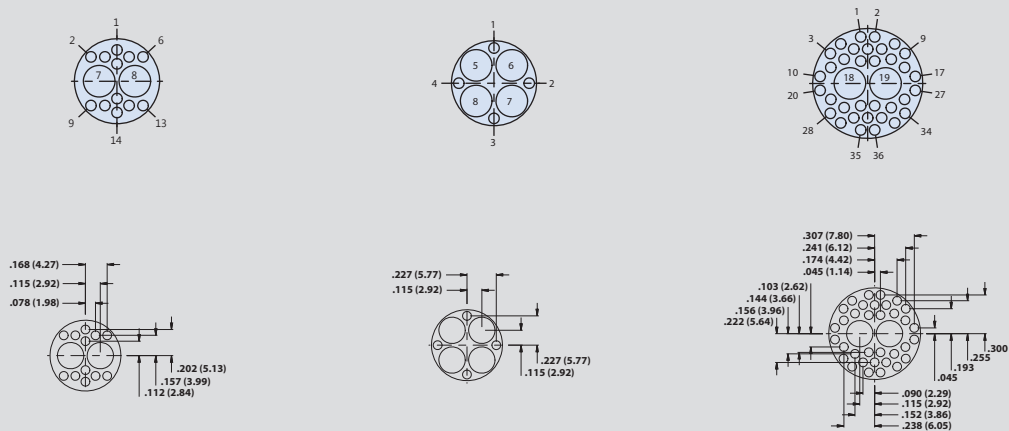

Series 800, 802, 803, 804	12-204		12-205		14-206 ¹	
Series 801	13-204		13-205		16-206	
Series 805	15-204		15-205		18-206	
Contact Size	#12	#23	#12	#23	#12	#23
No. of Contacts	2	12	4	4	2	34

1. Not available for Series 800 2. Not available for Series 803 or 804

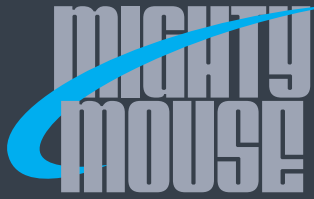

SERIES 80

Mighty Mouse Connectors and Cables



Size 16/23, 12/23, and 8/23 Combo Contact Layouts and PCB Footprints; Tested at 1300 VAC

SIZE 12 AND 23 COMBO CONTACT ARRANGEMENTS

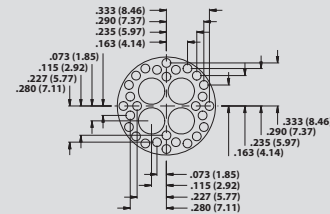
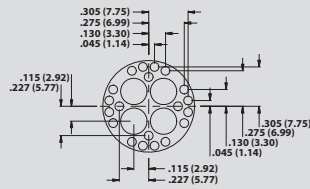
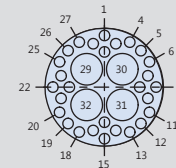
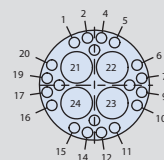

Series 800, 802, 803, 804	14-207 ¹		15-204 ^{1,2}	
Series 801	16-207		17-204	
Series 805	18-207		19-204	
Contact Size	#12	#23	#12	#23
No. of Contacts	4	20	4	20

SIZE 8 AND 23 COMBINATION CONTACT ARRANGEMENTS

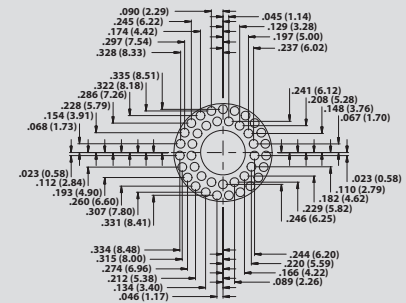
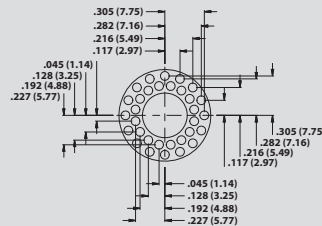
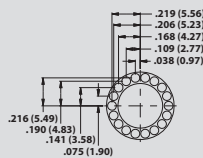
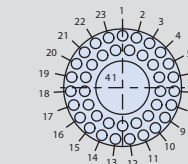
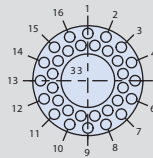
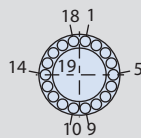

Series 800, 802, 803, 804	11-201		14-208 ¹		15-205 ^{1,2}	
Series 801	11-201		16-208		17-205	
Series 805	13-201		18-208		19-205	
Contact Size	#8	#23	#8	#23	#8	#23
No. of Contacts	1	18	1	32	1	40

1. Not available for Series 800 2. Not available for Series 803 or 804

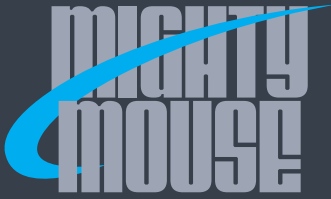

SERIES 80

Mighty Mouse Connectors and Cables



Size 16/23, 12/23, and 8/23 Combo Contact Layouts and PCB Footprints; Tested at 1300 VAC

SIZE 8 AND 23 COMBO CONTACT ARRANGEMENTS

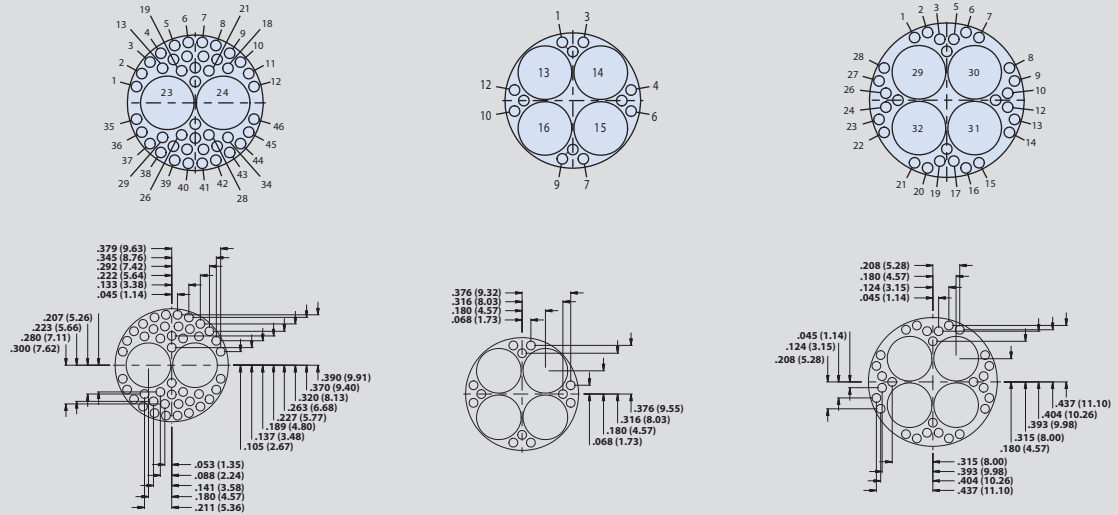

Series 800, 802, 803, 804	19-201 ^{1,2}		19-202 ^{1,2}		21-200 ^{1,2}	
Series 801	19-201		19-202		21-200	
Series 805	21-201		21-202		23-200	
Contact Size	#8	#23	#8	#23	#8	#23
No. of Contacts	2	44	4	12	4	28

General Information and Reference

1. Not available for Series 800 2. Not available for Series 803 or 804