

### 792-018S Quadrax PCB Plug Connectors

#### Epoxy-Sealed Straight PC Tail Quadrax Contacts

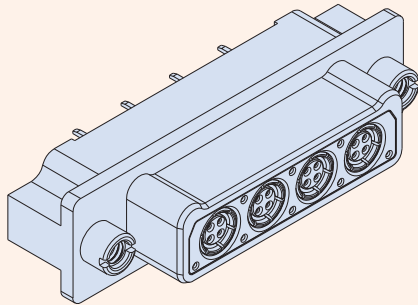

#### Technical Data

##### Specifications

- Operating temperature: -65 to +125 °C
- Current rating, size 23 contact: 5A
- Current rating, Ochito contacts: 1.5A
- Voltage rating (DWV): 500 Vac
- Shock: EIA-364-27 condition D
- Vibration: EIA-364-28 condition V, letter E
- Insulation Resistance: 5000 MΩ min.
- Shell-to-shell resistance with EMI spring: 2.5 mΩ max.
- Altitude immersion: 75,000 feet

##### Construction

- Shell: aluminum alloy
- Metal insert: aluminum, nickel plated
- Insulators: high-grade rigid dielectric
- Size 23 contacts: copper alloy, 50 microinches gold over nickel plating
- Ochito contacts  
inner and outer contacts: copper alloy, 50 microinches gold over nickel plating. Insulators: high-grade rigid thermoplastic. Spline: nickel-plated copper alloy (Ochito White), polyimide (Ochito Blue and Red)
- Hardware: 300 series SST, passivated

**Board mount Quadrax contacts. EMI protection.** Series 792 PCB mount Quadrax connectors are intended for 100BASE-T and ARINC 664 protocols. 792-018S connectors feature quadrax contacts with straight printed circuit board tails, machined aluminum shells and environmental protection. Scoop-proof interface for problem-free service. Military-grade performance and construction.

#### How To Order

	Sample P/N → <b>792-018S</b>	<b>D-12P4</b>	<b>MT</b>	<b>P</b>
<b>Product</b>	<b>792-018S</b> = PCB Plug, Quadrax Socket Contacts			
<b>Insert Arrangement</b>	See Table 2			
<b>Shell Finish</b>	<b>M</b> = Electroless Nickel <b>MT</b> = Nickel-PTFE			
<b>Mating Hardware (Table 1)</b>	<b>N</b> = No jackpost <b>P</b> = Jackpost <b>R1</b> = Rear panel jackpost, .032 (0.81) panel <b>R2</b> = Rear panel jackpost, .050 (1.27) panel <b>R3</b> = Rear panel jackpost, .062 (1.59) panel <b>R4</b> = Rear panel jackpost, .080 (2.03) panel <b>R5</b> = Rear panel jackpost, .093 (2.36) panel <b>R6</b> = Rear panel jackpost, .125 (3.18) panel			

#### Table 1 Hardware Option

 <b>N</b> <b>No Jackpost</b> Connector supplied with blind tapped holes	 <b>P</b> <b>Jackposts</b> Non-removable female jackpost. 8-32 UNC-2B thread.	 <b>R1 – R6</b> <b>Rear Panel Jackposts</b> For rear panel mounting. 8-32 UNC-2B thread.
--	--	---

#### Table 2 Insert Arrangements

Insert arrangement	Number of Contacts		Insert arrangement	Number of Contacts	
	#23	#8		#23	#8
<b>A-1P1, A-1G1*</b>		1	<b>D-27P3</b>	24	3
<b>A-3P1</b>	2	1	<b>D-4P4, D-4G4*</b>		4
<b>B-23P1</b>	22	1	<b>D-12P4</b>	8	4
<b>B-2P2, B-2G2*</b>		2	<b>E-45P3</b>	42	3
<b>B-6P2</b>	4	2	<b>E-5P5, E-5G5*</b>		5
<b>C-24P2</b>	22	2	<b>E-15P5</b>	10	5
<b>C-3P3, C-3G3*</b>		3	<b>F-9P9, F-9G9*</b>		9
<b>C-9P3</b>	6	3	<b>F-31P9</b>	22	9

Cavity identification numbers shown are for mating face of plug connectors with socket contacts.

\* Insert arrangements with "G" designator are grounded type with metal insert. Insert arrangements with "P" designator have thermoplastic dielectric.

# SERIES 792

## High-Speed Ultraminiature Rectangular Connectors



### 792-018S Quadrax PCB Plug Connectors

#### Epoxy-Sealed Straight PC Tail Quadrax Contacts

792-018S Dimensions										
Shell Size	A Max		B Basic		C Max		D Max		E ±.002 (0.05)	
	In.	mm.	In.	mm.	In.	mm.	In.	mm.	In.	mm.
<b>A</b>	1.455	36.96	1.075	27.31	.615	15.62	.460	11.68	.725	18.42
<b>B</b>	1.830	46.48	1.450	36.83	.990	25.15	.835	21.21	1.100	27.94
<b>C</b>	2.205	56.01	1.825	46.36	1.365	34.67	1.210	30.73	1.475	37.47
<b>D</b>	2.580	65.53	2.200	55.88	1.740	44.20	1.585	40.26	1.850	46.99
<b>E</b>	2.955	75.06	2.575	65.41	2.115	53.72	1.960	49.78	2.225	56.52
<b>F</b>	2.955	75.06	2.575	65.41	2.115	53.72	1.960	49.78	2.225	56.52

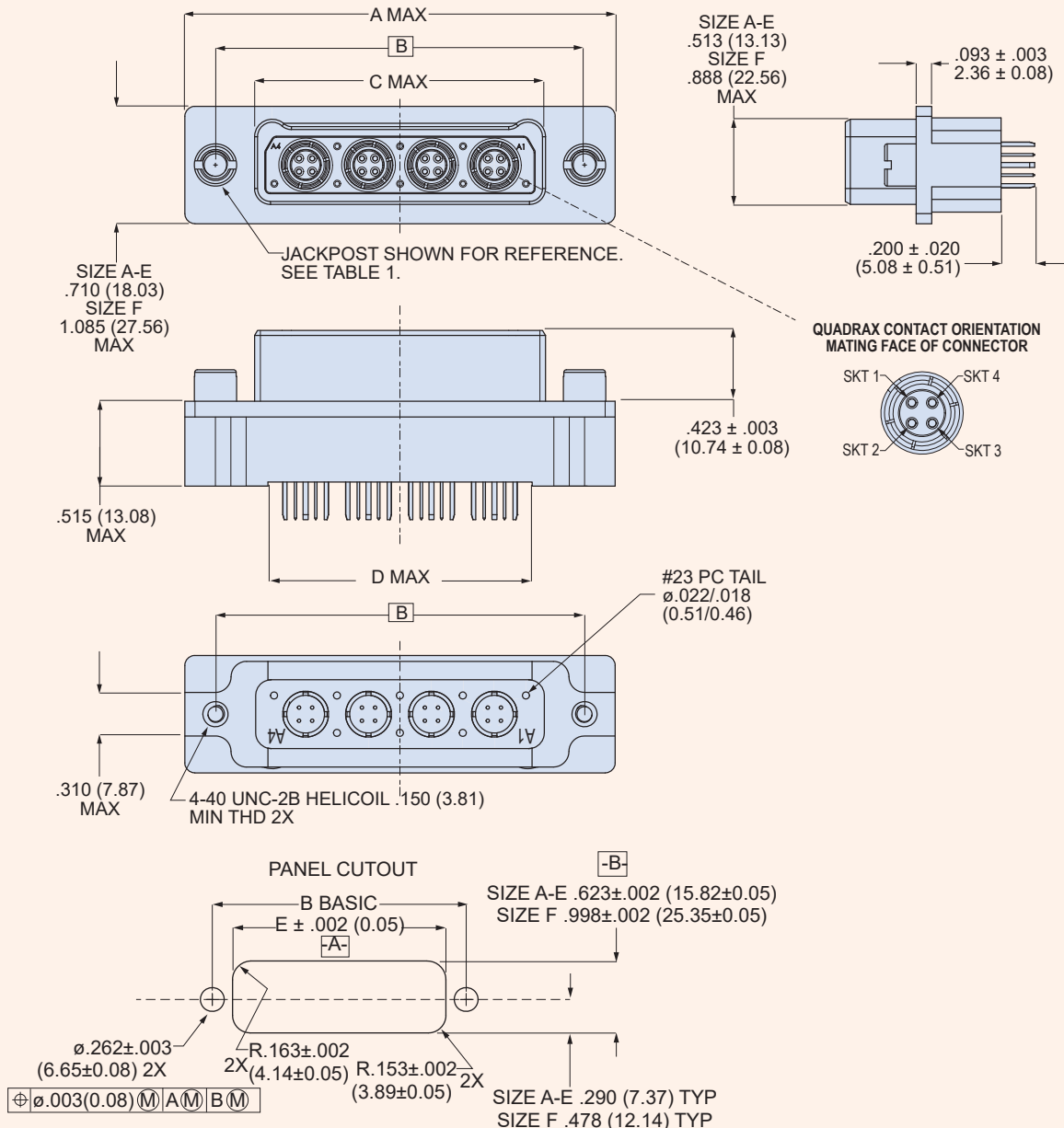

### 792-018S Quadrax PCB Plug Connectors Epoxy-Sealed Straight PC Tail Quadrax Contacts

#### 792-018S Printed Circuit Board Layouts

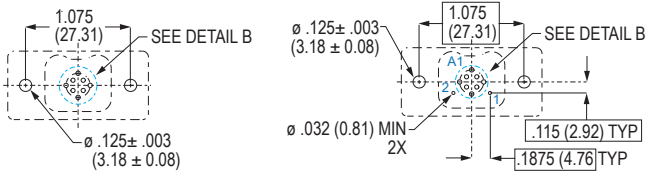

**A-1P1, A-1G1**

**A-3P1**

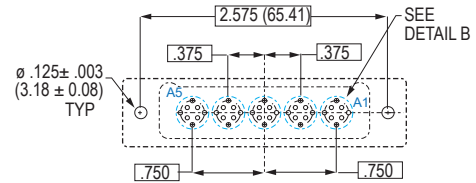

**E-5P5, E-5G5**

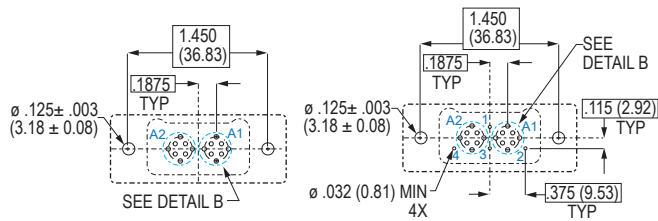

**B-2P2, B-2G2**

**B-6P2**

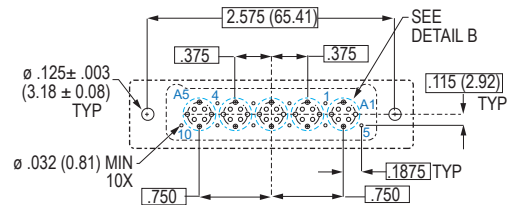

**E-15P5**

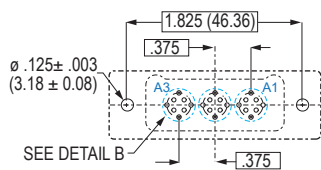

**C-3P3, C-3G3**

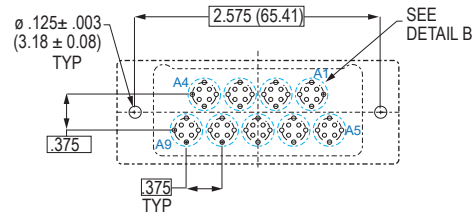

**F-9P9, F-9G9**

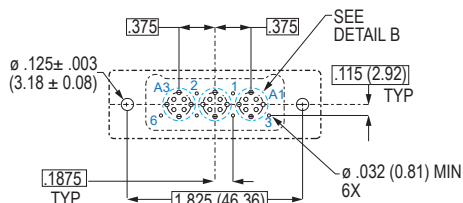

**C-9P3**

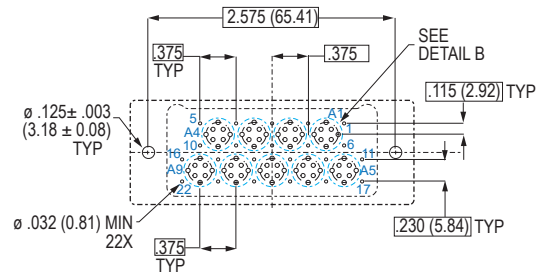

**F-31P9**

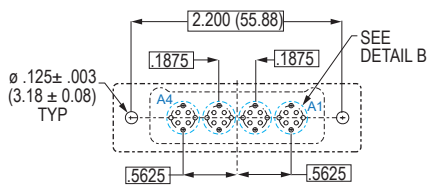

**D-4P4, D-4G4**

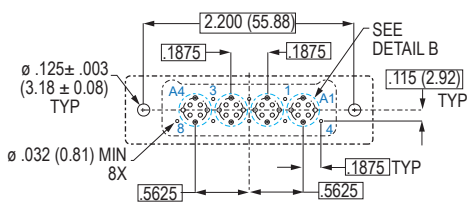

**D-12P4**

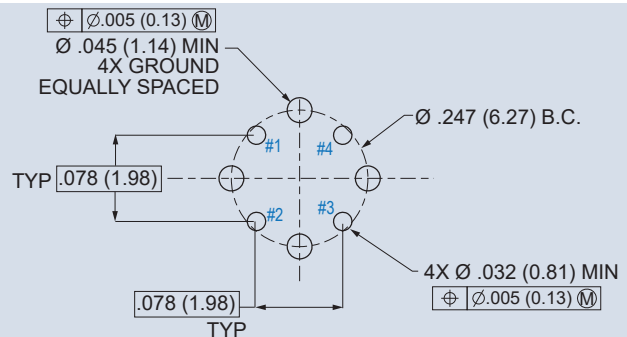

**DETAIL B**

QUADRAX SOCKET CONTACT  
COMPONENT SIDE OF BOARD